

# MSO4000B and DPO4000B Series Digital Phosphor Oscilloscopes User Manual



  
071-2810-02

**Tektronix**



**MSO4000B and DPO4000B Series  
Digital Phosphor Oscilloscopes  
User Manual**

Copyright © Tektronix. All rights reserved. Licensed software products are owned by Tektronix or its subsidiaries or suppliers, and are protected by national copyright laws and international treaty provisions.

Tektronix products are covered by U.S. and foreign patents, issued and pending. Information in this publication supersedes that in all previously published material. Specifications and price change privileges reserved.

TEKTRONIX and TEK are registered trademarks of Tektronix, Inc.

e\*Scope, iView, OpenChoice, TekSecure, and TekVPI are registered trademarks of Tektronix, Inc.

MagniVu and Wave Inspector are trademarks of Tektronix, Inc.

PictBridge is a registered trademark of the Standard of Camera & Imaging Products Association CIPA DC-001-2003 Digital Photo Solutions for Imaging Devices.

## Contacting Tektronix

Tektronix, Inc.  
14150 SW Karl Braun Drive  
P.O. Box 500  
Beaverton, OR 97077  
USA

For product information, sales, service, and technical support:

- In North America, call 1-800-833-9200.
- Worldwide, visit [www.tektronix.com](http://www.tektronix.com) to find contacts in your area.

## Warranty

Tektronix warrants that the product will be free from defects in materials and workmanship for a period of three (3) years from the date of original purchase from an authorized Tektronix distributor. If the product proves defective during this warranty period, Tektronix, at its option, either will repair the defective product without charge for parts and labor, or will provide a replacement in exchange for the defective product. Batteries are excluded from this warranty. Parts, modules and replacement products used by Tektronix for warranty work may be new or reconditioned to like new performance. All replaced parts, modules and products become the property of Tektronix.

In order to obtain service under this warranty, Customer must notify Tektronix of the defect before the expiration of the warranty period and make suitable arrangements for the performance of service. Customer shall be responsible for packaging and shipping the defective product to the service center designated by Tektronix, shipping charges prepaid, and with a copy of customer proof of purchase. Tektronix shall pay for the return of the product to Customer if the shipment is to a location within the country in which the Tektronix service center is located. Customer shall be responsible for paying all shipping charges, duties, taxes, and any other charges for products returned to any other locations.

This warranty shall not apply to any defect, failure or damage caused by improper use or improper or inadequate maintenance and care. Tektronix shall not be obligated to furnish service under this warranty a) to repair damage resulting from attempts by personnel other than Tektronix representatives to install, repair or service the product; b) to repair damage resulting from improper use or connection to incompatible equipment; c) to repair any damage or malfunction caused by the use of non-Tektronix supplies; or d) to service a product that has been modified or integrated with other products when the effect of such modification or integration increases the time or difficulty of servicing the product.

THIS WARRANTY IS GIVEN BY TEKTRONIX WITH RESPECT TO THE PRODUCT IN LIEU OF ANY OTHER WARRANTIES, EXPRESS OR IMPLIED. TEKTRONIX AND ITS VENDORS DISCLAIM ANY IMPLIED WARRANTIES OF MERCHANTABILITY OR FITNESS FOR A PARTICULAR PURPOSE. TEKTRONIX' RESPONSIBILITY TO REPAIR OR REPLACE DEFECTIVE PRODUCTS IS THE SOLE AND EXCLUSIVE REMEDY PROVIDED TO THE CUSTOMER FOR BREACH OF THIS WARRANTY. TEKTRONIX AND ITS VENDORS WILL NOT BE LIABLE FOR ANY INDIRECT, SPECIAL, INCIDENTAL, OR CONSEQUENTIAL DAMAGES IRRESPECTIVE OF WHETHER TEKTRONIX OR THE VENDOR HAS ADVANCE NOTICE OF THE POSSIBILITY OF SUCH DAMAGES.

[W16 – 15AUG04]

## Warranty

Tektronix warrants that the product will be free from defects in materials and workmanship for a period of one (1) year from the date of original purchase from an authorized Tektronix distributor. If the product proves defective during this warranty period, Tektronix, at its option, either will repair the defective product without charge for parts and labor, or will provide a replacement in exchange for the defective product. Batteries are excluded from this warranty. Parts, modules and replacement products used by Tektronix for warranty work may be new or reconditioned to like new performance. All replaced parts, modules and products become the property of Tektronix.

In order to obtain service under this warranty, Customer must notify Tektronix of the defect before the expiration of the warranty period and make suitable arrangements for the performance of service. Customer shall be responsible for packaging and shipping the defective product to the service center designated by Tektronix, shipping charges prepaid, and with a copy of customer proof of purchase. Tektronix shall pay for the return of the product to Customer if the shipment is to a location within the country in which the Tektronix service center is located. Customer shall be responsible for paying all shipping charges, duties, taxes, and any other charges for products returned to any other locations.

This warranty shall not apply to any defect, failure or damage caused by improper use or improper or inadequate maintenance and care. Tektronix shall not be obligated to furnish service under this warranty a) to repair damage resulting from attempts by personnel other than Tektronix representatives to install, repair or service the product; b) to repair damage resulting from improper use or connection to incompatible equipment; c) to repair any damage or malfunction caused by the use of non-Tektronix supplies; or d) to service a product that has been modified or integrated with other products when the effect of such modification or integration increases the time or difficulty of servicing the product.

THIS WARRANTY IS GIVEN BY TEKTRONIX WITH RESPECT TO THE PRODUCT IN LIEU OF ANY OTHER WARRANTIES, EXPRESS OR IMPLIED. TEKTRONIX AND ITS VENDORS DISCLAIM ANY IMPLIED WARRANTIES OF MERCHANTABILITY OR FITNESS FOR A PARTICULAR PURPOSE. TEKTRONIX' RESPONSIBILITY TO REPAIR OR REPLACE DEFECTIVE PRODUCTS IS THE SOLE AND EXCLUSIVE REMEDY PROVIDED TO THE CUSTOMER FOR BREACH OF THIS WARRANTY. TEKTRONIX AND ITS VENDORS WILL NOT BE LIABLE FOR ANY INDIRECT, SPECIAL, INCIDENTAL, OR CONSEQUENTIAL DAMAGES IRRESPECTIVE OF WHETHER TEKTRONIX OR THE VENDOR HAS ADVANCE NOTICE OF THE POSSIBILITY OF SUCH DAMAGES.

[W15 – 15AUG04]

# Table of Contents

General Safety Summary .....	v
Compliance Information .....	vii
EMC Compliance.....	vii
Safety Compliance .....	viii
Environmental Considerations.....	ix
Preface .....	xi
Key Features .....	xi
Conventions Used in This Manual.....	xii
Installation.....	1
Before Installation .....	1
Operating Considerations.....	5
Operating Positions .....	7
Connecting Probes.....	8
Securing the Oscilloscope .....	9
Powering on the Oscilloscope .....	10
Powering off the Oscilloscope .....	11
Functional Check.....	11
Compensating a TPP0500 or TPP1000 Passive Voltage Probe.....	12
Compensating a non-TPP0500 or non-TPP1000 Passive Voltage Probe.....	14
Application Module Free Trial.....	15
Installing an Application Module.....	15
Changing the Language of the User Interface or Keyboard.....	16
Changing the Date and Time .....	17
Signal Path Compensation .....	19
Upgrading Firmware .....	20
Connecting Your Oscilloscope to a Computer .....	23
Connecting a USB Keyboard to Your Oscilloscope.....	27
Get Acquainted with the Instrument .....	29
Front-Panel Menus and Controls.....	29
Front-Panel Connectors .....	41
Side-Panel Connector.....	41
Rear-Panel Connectors.....	42
Acquire the Signal .....	44
Setting Up Analog Channels.....	44
Using the Default Setup.....	47
Using Autoset .....	48
Acquisition Concepts.....	49
How the Analog Acquisition Modes Work.....	51
Changing the Acquisition Mode, Record Length, and Delay Time.....	51
Using Roll Mode.....	53
Setting Up a Serial or Parallel Bus .....	54
Setting Up Digital Channels .....	67

When and Why to Turn On MagniVu .....	69
Using MagniVu .....	69
Trigger Setup .....	70
Triggering Concepts.....	70
Choosing a Trigger Type.....	73
Selecting Triggers .....	74
Triggering on Buses.....	76
Checking Trigger Settings .....	80
Using Sequence Trigger (A (Main) and B (Delayed)).....	81
Starting and Stopping an Acquisition.....	83
Display Waveform Data .....	84
Adding and Removing a Waveform .....	84
Setting the Display Style and Persistence .....	84
Setting Waveform Intensity .....	88
Scaling and Positioning a Waveform .....	89
Setting Input Parameters .....	90
Positioning and Labeling Bus Signals.....	94
Positioning, Scaling, and Grouping Digital Channels.....	94
Viewing Digital Channels .....	96
Annotating the Screen .....	96
Viewing the Trigger Frequency .....	97
Analyze Waveform Data.....	99
Taking Automatic Measurements.....	99
Selecting Automatic Measurements.....	100
Customizing an Automatic Measurement .....	104
Taking Manual Measurements with Cursors .....	108
Setting Up a Histogram .....	112
Using Math Waveforms .....	115
Using FFT .....	116
Using Advanced Math.....	119
Using Reference Waveforms .....	120
Using Wave Inspector to Manage Long Record Length Waveforms.....	122
Limit and Mask Testing.....	127
Analyzing Power .....	133
Save and Recall Information .....	134
Saving a Screen Image .....	136
Saving and Recalling Waveform Data.....	137
Saving and Recalling Setups .....	139
Saving with One Button Push .....	141
Managing Drives, Directories, and Files .....	142
Mounting a Network Drive .....	142
Printing a Hard Copy.....	143
Erasing Oscilloscope Memory.....	149



Using Application Modules .....	151
Application Examples .....	152
Taking Simple Measurements .....	152
Analyzing Signal Detail .....	159
Triggering on a Video Signal .....	163
Capturing a Single-Shot Signal .....	165
Correlating Data with a TLA Logic Analyzer .....	169
Tracking Down Bus Anomalies .....	170
Troubleshooting Circuits Using Parallel Buses .....	172
Troubleshooting an RS-232 Bus .....	174
Appendix A: MSO/DPO4000B Specifications .....	176
Appendix B: TPP0500 and TPP1000 500 MHz and 1 GHz 10X Passive Probes Information .....	181
Operating Information .....	181
Connecting the Probe to the Oscilloscope .....	181
Compensating the Probe with MSO/DPO4000B Oscilloscopes .....	181
Standard Accessories .....	181
Optional Accessories .....	183
Replacing the Probe Tip .....	183
Specifications .....	184
Performance Graphs .....	184
Safety Summary .....	186
Appendix C: P6616 General-Purpose Logic Probe Information .....	188
Product Description .....	188
Connecting the Probe to the Oscilloscope .....	188
Connecting the Probe to Your Circuit .....	189
Functional Check .....	189
Typical Application .....	190
Accessories .....	190
Specifications .....	191
Safety Summary .....	192
Safety Terms and Symbols in This Manual .....	192
Index .....	



# General Safety Summary

Review the following safety precautions to avoid injury and prevent damage to this product or any products connected to it.

To avoid potential hazards, use this product only as specified.

*Only qualified personnel should perform service procedures.*

## To Avoid Fire or Personal Injury

**Use proper power cord.** Use only the power cord specified for this product and certified for the country of use.

**Connect and disconnect properly.** Do not connect or disconnect probes or test leads while they are connected to a voltage source.

**Connect and disconnect properly.** De-energize the circuit under test before connecting or disconnecting the current probe.

**Ground the product.** This product is grounded through the grounding conductor of the power cord. To avoid electric shock, the grounding conductor must be connected to earth ground. Before making connections to the input or output terminals of the product, ensure that the product is properly grounded.

**Observe all terminal ratings.** To avoid fire or shock hazard, observe all ratings and markings on the product. Consult the product manual for further ratings information before making connections to the product.

Connect the probe reference lead to earth ground only.

Do not apply a potential to any terminal, including the common terminal, that exceeds the maximum rating of that terminal.

**Power disconnect.** The power cord disconnects the product from the power source. Do not block the power cord; it must remain accessible to the user at all times.

**Do not operate without covers.** Do not operate this product with covers or panels removed.

**Do not operate with suspected failures.** If you suspect that there is damage to this product, have it inspected by qualified service personnel.

**Avoid exposed circuitry.** Do not touch exposed connections and components when power is present.

**Do not operate in wet/damp conditions.**

**Do not operate in an explosive atmosphere.**

**Keep product surfaces clean and dry.**

**Provide proper ventilation.** Refer to the manual's installation instructions for details on installing the product so it has proper ventilation.

## Terms in This Manual

These terms may appear in this manual:



---

**WARNING.** *Warning statements identify conditions or practices that could result in injury or loss of life.*

---



---

**CAUTION.** *Caution statements identify conditions or practices that could result in damage to this product or other property.*

---

## Symbols and Terms on the Product

These terms may appear on the product:

- DANGER indicates an injury hazard immediately accessible as you read the marking.
- WARNING indicates an injury hazard not immediately accessible as you read the marking.
- CAUTION indicates a hazard to property including the product.

The following symbol(s) may appear on the product:



## Compliance Information

This section lists the EMC (electromagnetic compliance), safety, and environmental standards with which the instrument complies.

### EMC Compliance

#### EC Declaration of Conformity – EMC

Meets intent of Directive 2004/108/EC for Electromagnetic Compatibility. Compliance was demonstrated to the following specifications as listed in the Official Journal of the European Communities:

**EN 61326-1:2006, EN 61326-2-1:2006.** EMC requirements for electrical equipment for measurement, control, and laboratory use. <sup>1 2 3 4</sup>

- CISPR 11:2003. Radiated and conducted emissions, Group 1, Class A
- IEC 61000-4-2:2001. Electrostatic discharge immunity
- IEC 61000-4-3:2002. RF electromagnetic field immunity <sup>5</sup>
- IEC 61000-4-4:2004. Electrical fast transient/burst immunity
- IEC 61000-4-5:2001. Power line surge immunity
- IEC 61000-4-6:2003. Conducted RF immunity <sup>6</sup>
- IEC 61000-4-11:2004. Voltage dips and interruptions immunity <sup>7</sup>

**EN 61000-3-2:2006.** AC power line harmonic emissions

**EN 61000-3-3:1995.** Voltage changes, fluctuations, and flicker

#### European contact.

Tektronix UK, Ltd.  
Western Peninsula  
Western Road  
Bracknell, RG12 1RF  
United Kingdom

- <sup>1</sup> This product is intended for use in nonresidential areas only. Use in residential areas may cause electromagnetic interference.
- <sup>2</sup> Emissions which exceed the levels required by this standard may occur when this equipment is connected to a test object.
- <sup>3</sup> To ensure compliance with the EMC standards listed here, high quality shielded interface cables should be used.
- <sup>4</sup> Instrument rebooting may be experienced where the EUT takes longer than 10 seconds to recover from a transient immunity test.
- <sup>5</sup> The instrument will exhibit  $\leq 4.0$  division waveform displacement and  $\leq 8.0$  division increase in peak-to-peak noise when subjected to radiated interference per IEC 61000-4-3.
- <sup>6</sup> The instrument will exhibit  $\leq 1.0$  division waveform displacement and  $\leq 2.0$  division increase in peak-to-peak noise when subjected to conducted interference per IEC 61000-4-6.
- <sup>7</sup> Performance Criterion C applied at the 70%/25 cycle Voltage-Dip and the 0%/250 cycle Voltage-Interruption test levels (IEC 61000-4-11).

### **Australia / New Zealand Declaration of Conformity – EMC**

Complies with the EMC provision of the Radiocommunications Act per the following standard, in accordance with ACMA:

- CISPR 11:2003. Radiated and Conducted Emissions, Group 1, Class A, in accordance with EN 61326-1:2006 and EN 61326-2-1:2006.

#### **Australia / New Zealand contact.**

Baker & McKenzie  
Level 27, AMP Centre  
50 Bridge Street  
Sydney NSW 2000, Australia

## **Safety Compliance**

### **EC Declaration of Conformity – Low Voltage**

Compliance was demonstrated to the following specification as listed in the Official Journal of the European Communities:

Low Voltage Directive 2006/95/EC.

- EN 61010-1: 2001. Safety requirements for electrical equipment for measurement control and laboratory use.

### **U.S. Nationally Recognized Testing Laboratory Listing**

- UL 61010-1:2004, 2<sup>nd</sup> Edition. Standard for electrical measuring and test equipment.

### **Canadian Certification**

- CAN/CSA-C22.2 No. 61010-1:2004. Safety requirements for electrical equipment for measurement, control, and laboratory use. Part 1.

### **Additional Compliances**

- IEC 61010-1: 2001. Safety requirements for electrical equipment for measurement, control, and laboratory use.

### **Equipment Type**

Test and measuring equipment.

### **Safety Class**

Class 1 – grounded product.

## Pollution Degree Description

A measure of the contaminants that could occur in the environment around and within a product. Typically the internal environment inside a product is considered to be the same as the external. Products should be used only in the environment for which they are rated.

- Pollution Degree 1. No pollution or only dry, nonconductive pollution occurs. Products in this category are generally encapsulated, hermetically sealed, or located in clean rooms.
- Pollution Degree 2. Normally only dry, nonconductive pollution occurs. Occasionally a temporary conductivity that is caused by condensation must be expected. This location is a typical office/home environment. Temporary condensation occurs only when the product is out of service.
- Pollution Degree 3. Conductive pollution, or dry, nonconductive pollution that becomes conductive due to condensation. These are sheltered locations where neither temperature nor humidity is controlled. The area is protected from direct sunshine, rain, or direct wind.
- Pollution Degree 4. Pollution that generates persistent conductivity through conductive dust, rain, or snow. Typical outdoor locations.

## Pollution Degree

Pollution Degree 2 (as defined in IEC 61010-1). Note: Rated for indoor use only.

## Installation (Overvoltage) Category Descriptions

Terminals on this product may have different installation (overvoltage) category designations. The installation categories are:

- Measurement Category IV. For measurements performed at the source of low-voltage installation.
- Measurement Category III. For measurements performed in the building installation.
- Measurement Category II. For measurements performed on circuits directly connected to the low-voltage installation.
- Measurement Category I. For measurements performed on circuits not directly connected to MAINS.

## Overvoltage Category

Overvoltage Category II (as defined in IEC 61010-1).

## Environmental Considerations

This section provides information about the environmental impact of the product.

### Product End-of-Life Handling

Observe the following guidelines when recycling an instrument or component:

**Equipment recycling.** Production of this equipment required the extraction and use of natural resources. The equipment may contain substances that could be harmful to the environment or human health if improperly handled at the product's end of life. In

order to avoid release of such substances into the environment and to reduce the use of natural resources, we encourage you to recycle this product in an appropriate system that will ensure that most of the materials are reused or recycled appropriately.



This symbol indicates that this product complies with the applicable European Union requirements according to Directives 2002/96/EC and 2006/66/EC on waste electrical and electronic equipment (WEEE) and batteries. For information about recycling options, check the Support/Service section of the Tektronix Web site ([www.tektronix.com](http://www.tektronix.com)).

### **Restriction of Hazardous Substances**

This product has been classified as Monitoring and Control equipment, and is outside the scope of the 2002/95/EC RoHS Directive.



## Preface

This manual describes the installation and operation of the following oscilloscopes:

Model	Bandwidth	Analog Channels	Sample Rate (1 ch)	Sample Rate (2 ch)	Sample Rate (4 ch)	Record Length (1 ch)	Record Length (2 ch)	Record Length (4 ch)
MSO4104B	1 GHz	4	5 GS/s	5 GS/s	5 GS/s	20M	20M	20M
MSO4104B-L	1 GHz	4	5 GS/s	5 GS/s	2.5 GS/s	5M	5M	5M
MSO4102B	1 GHz	2	5 GS/s	5 GS/s	--	20M	20M	--
MSO4102B-L	1 GHz	2	5 GS/s	2.5 GS/s	--	5M	5M	--
MSO4054B	500 MHz	4	2.5 GS/s	2.5 GS/s	2.5 GS/s	20M	20M	20M
MSO4034B	350 MHz	4	2.5 GS/s	2.5 GS/s	2.5 GS/s	20M	20M	20M
DPO4104B	1 GHz	4	5 GS/s	5 GS/s	5 GS/s	20M	20M	20M
DPO4104B-L	1 GHz	4	5 GS/s	5 GS/s	2.5 GS/s	5M	5M	5M
DPO4102B	1 GHz	2	5 GS/s	5 GS/s	--	20M	20M	--
DPO4102B-L	1 GHz	2	5 GS/s	2.5 GS/s	--	5M	5M	--
DPO4054B	500 MHz	4	2.5 GS/s	2.5 GS/s	2.5 GS/s	20M	20M	20M
DPO4034B	350 MHz	4	2.5 GS/s	2.5 GS/s	2.5 GS/s	20M	20M	20M

## Key Features

MSO4000B and DPO4000B Series instruments can help you verify, debug, and characterize electronic designs. Key features include:

- 1 GHz, 500 MHz, and 350 MHz bandwidths
- Sample rates up to either 2.5 or 5 GS/s on all analog channels
- Record length up to either 5 M or 20 M points on all analog channels
- >50,000 waveforms/second display rate
- Advanced triggering and analysis: I<sup>2</sup>C, SPI, USB 2.0, CAN, LIN, FlexRay, RS-232, RS-422, RS-485, UART, I<sup>2</sup>S, Left Justified (LJ), Right Justified (RJ), TDM, Ethernet, MIL-STD-1553, and Parallel (with the appropriate application module and oscilloscope model)
- Power analysis application module (optional)
- 16 digital channels (MSO Series)

## Conventions Used in This Manual

The following icons are used throughout this manual.

Sequence Step



Front panel power



Connect power

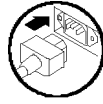

Network

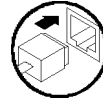

USB

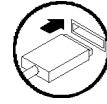

# Installation

## Before Installation

Unpack the oscilloscope and check that you received all items listed as standard accessories. The following pages list recommended accessories and probes, instrument options, and upgrades. Check the Tektronix Web site ([www.tektronix.com](http://www.tektronix.com)) for the most current information.

### Standard accessories

Accessory	Description	Tektronix part number
<i>MSO4000B and DPO4000B Series Oscilloscopes User Manual</i>	English (Option L0)	071-2810-XX
	French (Option L1)	071-2811-XX
	Italian (Option L2)	071-2812-XX
	German (Option L3)	071-2813-XX
	Spanish (Option L4)	071-2814-XX
	Japanese (Option L5)	071-2815-XX
	Portuguese (Option L6)	071-2816-XX
	Simplified Chinese (Option L7)	071-2817-XX
	Traditional Chinese (Option L8)	071-2818-XX
	Korean (Option L9)	071-2819-XX
Russian (Option L10)	071-2820-XX	
<i>MSO4000B and DPO4000B Series Oscilloscopes Documentation Browser CD</i>	Electronic versions of documents, including the Programmer Manual and the Technical Reference.	063-4300-XX
<i>NI LabVIEW SignalExpress™, Tektronix Edition and Tektronix OpenChoice Desktop CD</i>	Productivity, analysis, and documentation software	063-3967-XX
Calibration certificate documenting traceability to national metrology institute(s), and ISO9001 quality system registration.		—
Front Panel Overlay	French (Option L1)	335-2366-XX
	Italian (Option L2)	335-2367-XX
	German (Option L3)	335-2368-XX
	Spanish (Option L4)	335-2369-XX
	Japanese (Option L5)	335-2370-XX
	Portuguese (Option L6)	335-2371-XX
	Simplified Chinese (Option L7)	335-2372-XX
	Traditional Chinese (Option L8)	335-2373-XX
	Korean (Option L9)	335-2374-XX
	Russian (Option L10)	335-2375-XX

**Standard accessories (cont.)**

<b>Accessory</b>	<b>Description</b>	<b>Tektronix part number</b>
For MSO4000B and DPO4000B Series: Probes	For 350 MHz and 500 MHz models, one 500 MHz, 10X passive probe per channel	TPP0500
	For 1 GHz models, one 1 GHz, 10X passive probe per channel	TPP1000
Front Cover	Hard plastic cover to help protect the instrument	200-5130-00
Power Cord	North America (Option A0)	161-0104-00
	Universal Euro (Option A1)	161-0104-06
	United Kingdom (Option A2)	161-0104-07
	Australia (Option A3)	161-0104-05
	Switzerland (Option A5)	161-0167-00
	Japan (Option A6)	161-A005-00
	China (Option A10)	161-0306-00
	India (Option A11)	161-0400-00
	Brazil (Option A12)	161-0357-00
	No power cord or AC adapter (Option A99)	—
For MSO4000B Series: Logic probe	One, 16-channel logic probe, with accessories	P6616

**Optional accessories**

<b>Accessory</b>	<b>Description</b>	<b>Tektronix part number</b>
Aerospace serial triggering and analysis application module	This module enables triggering on MIL-STD-1553 serial buses. Also, it provides digital views of the signal, bus views, bus decoding, search tools, and decode tables with time stamp information.	DPO4AERO
Audio serial triggering and analysis application module	This module enables triggering on I <sup>2</sup> S, Left Justified (LJ), Right Justified (RJ), and TDM audio buses. Also, it provides digital views of the signal, bus views, packet decoding, search tools, and packet decode tables with time stamp information	DPO4AUDIO
Automotive serial triggering and analysis application module	This module enables triggering on packet level information on CAN and LIN serial buses. Also, it provides a digital view of the signal, bus view, packet decoding, search tools, and a packet decode table with time stamp information.	DPO4AUTO
FlexRay, CAN, and LIN serial triggering and analysis application module	This module enables triggering on packet level information in FlexRay, CAN, and LIN buses. Also, it provides digital views of the signal, bus views, packet decoding, search tools, packet decode tables with time stamp information and eye diagram analysis software.	DPO4AUTOMAX

## Optional accessories (cont.)

Accessory	Description	Tektronix part number
Computer triggering and analysis application module	This module enables triggering on RS-232, RS-422, RS-485 and UART serial buses. Also, it provides digital views of the signal, bus views, packet decoding, search tools, and packet decode tables with time stamp information.	DPO4COMP
Embedded serial triggering and analysis application module	This module enables triggering on packet level information on I <sup>2</sup> C and SPI serial buses. Also, it provides digital views of the signal, bus views, packet decoding, search tools, and packet decode tables with time stamp information.	DPO4EMBD
Ethernet serial triggering and analysis application module	This module enables triggering on 10BASE-T and 100BASE-TX buses. Also, it provides digital views of the signal, bus views, packet decoding, search tools, and packet decode tables with time stamp information.	DPO4ENET
Limit and mask test application module	This module supports limit testing and testing on custom masks or standard telecom or computer masks.	DPO4LMT
Power analysis application module	This module supports measurements of power quality, switching loss, harmonics, ripple, modulation, safe operating area, and slew rate (dV/dt and dI/dt).	DPO4PWR
Universal Serial Bus triggering and analysis application module	This module enables triggering on packet level information on USB 2.0 serial buses. Also, it provides digital views of the signal, bus views, bus decoding data in hex, binary, and ASCII, search tools, and packet decode tables with time stamp information.	DPO4USB
Extended video application module	This module enables triggering on a variety of standard HDTV signals, as well as on custom (non-standard) bilevel and trilevel video signals with 3 to 4,000 lines.	DPO4VID
NEX-HD2HEADER	Adapter that routes the channels from a Mictor connector to 0.1 inch header pins	NEX-HD2HEADER
TPA-BNC	TekVPI to TekProbe II BNC Adapter	TPA-BNC
TEK-USB-488 Adapter	GPIB to USB Adapter	TEK-USB-488
Rackmount kit	Adds rackmount brackets	RMD5000
Soft transit case	Case for carrying instrument	ACD4000B
Hard transit case	Traveling case, which requires use of the soft transit case (AC4000B)	HCTEK54

### Optional accessories (cont.)

Accessory	Description	Tektronix part number
MSO4000B and DPO4000B Series Oscilloscopes Programmer Manual	Describes commands for remote control of the oscilloscope. Available electronically on the Documentation Browser CD or for download from <a href="http://www.tektronix.com/manuals">www.tektronix.com/manuals</a> .	077-0510-XX
MSO4000B and DPO4000B Series Oscilloscopes Technical Reference Manual	Describes the oscilloscope specifications and performance verification procedure. Available electronically on the Documentation Browser CD or for download from <a href="http://www.tektronix.com/manuals">www.tektronix.com/manuals</a> .	077-0509-XX
MSO4000B and DPO4000B Series Oscilloscopes Service Manual	Service information on MSO4000B and DPO4000B oscilloscopes	077-0512-XX
MDO4000, MSO4000, MSO4000B, DPO4000, and DPO4000B Series Application Model Installation Instructions	Describes how to install application modules on your oscilloscope	071-2136-XX
DPO3PWR and DPO4PWR Power Measurement Module User Manual	English (Option L0)	071-2631-XX
	French (Option L1)	077-0235-XX
	Italian (Option L2)	077-0236-XX
	German (Option L3)	077-0237-XX
	Spanish (Option L4)	077-0238-XX
	Japanese (Option L5)	077-0239-XX
	Portuguese (Option L6)	077-0240-XX
	Simplified Chinese (Option L7)	077-0241-XX
	Traditional Chinese (Option L8)	077-0242-XX
	Korean (Option L9)	077-0243-XX
Russian (Option L10)	077-0244-XX	
MSO4000B and DPO4000B Series Oscilloscopes Declassification and Security Instructions	Describes how to sanitize or remove memory devices from the Tektronix MSO4000B and DPO4000B oscilloscopes.	077-0511-00

The MSO4000B and DPO4000B Series oscilloscopes work with multiple optional probes. (See page 8, *Connecting Probes*.) Check the Tektronix Web site ([www.tektronix.com](http://www.tektronix.com)) for the most current information.

## Operating Considerations

### MSO4000B and DPO4000B Series Oscilloscopes

#### Operating Line Frequency and Voltage Range

Volts	Hz
100-240	50-60
115	400

Mains input voltage range: 100 V - 240 V and 115 V

Maximum Power Consumption: 225 W

#### Weight:

5.0 kg (11.0 lbs), standalone instrument, without front cover

Height, feet folded in, handle folded down:  
229 mm (9.0 in)

Width, from handle hub to handle hub: 439 mm  
(17.3 in)

Depth, from back of feet to front of knobs: 140 mm  
(5.5 in)

Depth, from back of feet to front of front cover: 155 mm  
(6.1 in)

#### Temperature:

Operating: +0 °C to +50 °C (+32 °F to 122 °F)

Nonoperating: -20 °C to +60 °C (-4 °F to 140 °F)

#### Humidity:

Operating: High: 40 °C to 50 °C (104 °F to 122 °F),  
10% to 60% RH

Operating: Low: 0 °C to 40 °C (32 °F to 104 °F), 10  
to 90% RH

Non-operating: High: 40 °C to 60 °C (104 °F to  
140 °F), 5 to 60% RH

Non-operating: Low: 0 °C to 40 °C (32 °F to 104 °F),  
5 to 90% RH

#### Altitude:

Operating: 3,000 m (about 9,843 ft)

Nonoperating Altitude: 9,144 m (30,000 ft)

Pollution Degree: 2, Indoor use only

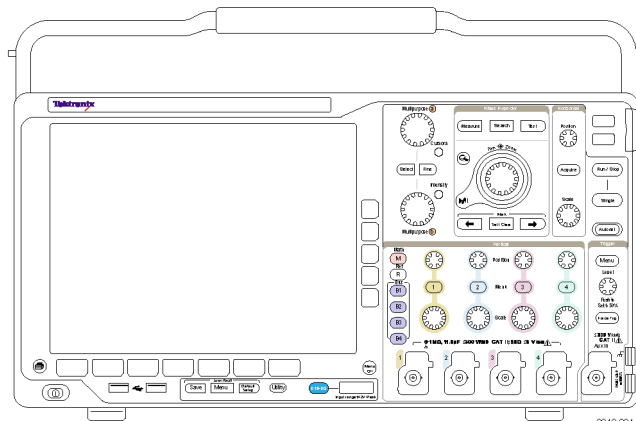

2810-001

MSO4000B Series

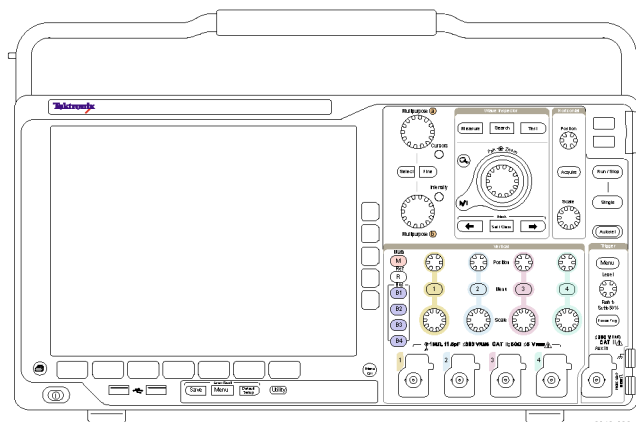

2810-002

DPO4000B Series

### Acquisition System: 1 M $\Omega$

The maximum input voltage at the BNC, 300 V<sub>RMS</sub>. Installation Category II. For <100 mV, derate at 20 dB/decade above 100 kHz to 30 V<sub>RMS</sub> at 1 MHz, 10 dB/decade above 1 MHz.

For  $\geq$  100 mV/div, derate at 20 dB/decade above 3 MHz at 30 V<sub>RMS</sub> to 30 MHz, 10 dB/decade above 30 MHz.

### Acquisition System: 50 $\Omega$

5 V<sub>RMS</sub>, with peaks  $\leq \pm 20$  V (DF  $\leq$  6.25%)

### Acquisition System: Digital Inputs

Threshold voltage range is  $\pm 40$  V.

### Aux In:

The maximum input voltage at the BNC, 300 V<sub>RMS</sub>.

Installation Category II (CAT II)

Derate at 20 dB/decade above 3 MHz to 30 V<sub>RMS</sub> at 30 MHz, 10 dB/decade above 30 MHz





**CAUTION.** To ensure proper cooling, keep the sides and rear of the instrument clear of obstructions. Ventilation clearance should be at least 51 mm (2 in) on the left side, when looking at the front of the instrument, and on the rear of the instrument

Find more information on MSO/DPO4000B oscilloscope specifications in Appendix A. (See page 176, *Appendix A: MSO/DPO4000B Specifications*.)

Find information on TPP0500/TPP1000 probes in Appendix B. (See page 181, *Appendix B: TPP0500 and TPP1000 500 MHz and 1 GHz 10X Passive Probes Information*.)

Find information on P6616 probes in Appendix C. (See page 188, *Appendix C: P6616 General-Purpose Logic Probe Information*.)

## Cleaning

Inspect the oscilloscope and probes as often as operating conditions require. To clean the exterior surface, perform the following steps:

1. Remove loose dust on the outside of the oscilloscope and probes with a lint-free cloth. Use care to avoid scratching the display.
2. Use a soft cloth dampened with water to clean the oscilloscope. Use an aqueous solution of 75% isopropyl alcohol for more efficient cleaning.



**CAUTION.** Avoid getting moisture inside the unit during external cleaning. Use only enough cleaning solution to dampen the cloth or swab.



**CAUTION.** To avoid damage to the surface of the oscilloscope or probes, do not use any abrasive or chemical cleaning agents.

## Operating Positions

Use the handle and front flip feet to place the oscilloscope in a convenient operating position. When the feet are extended, always have the handle in a down position.

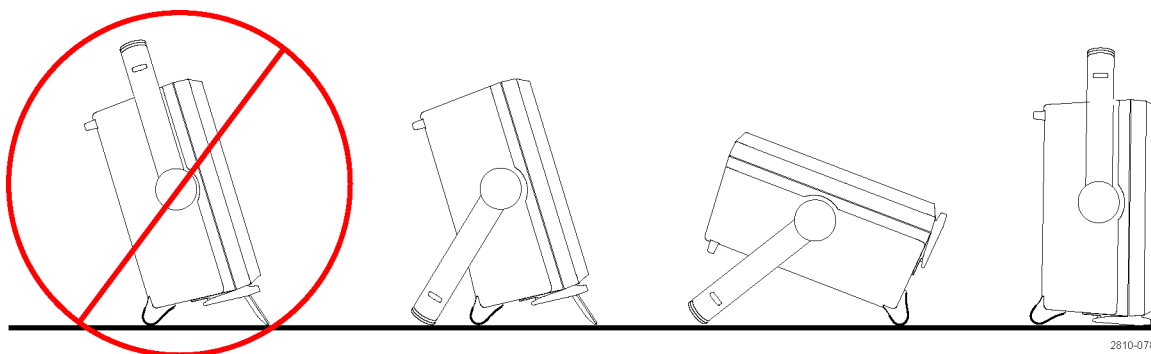

2810-078

## Connecting Probes

The oscilloscope supports probes with the following:

### 1. Tektronix Versatile Probe Interface (TekVPI)

These probes support two-way communication with the oscilloscope through on-screen menus and remotely through programmable support. The remote control is useful in applications like ATE where you want the system to preset probe parameters.

### 2. Tektronix Versatile Probe Interface (TekVPI) for Passive Probes

These probes build upon the functionality of the TekVPI interface. Each probe is matched with its corresponding oscilloscope channel, allowing the oscilloscope to optimize the signal input path. This provides AC compensation across the frequency band.

### 3. TPA-BNC Adapter

The TPA-BNC Adapter allows you to use TEKPROBE II probe capabilities, such as providing probe power, and passing scaling and unit information to the oscilloscope.

### 4. BNC Interfaces

Some of these use TEKPROBE capabilities to pass the waveform signal and scaling to the oscilloscope. Some only pass the signal and there is no other communication.

### 5. Logic Probe Interface (MSO4000B Series only)

The P6616 probe provides 16 channels of digital (on or off state) information.

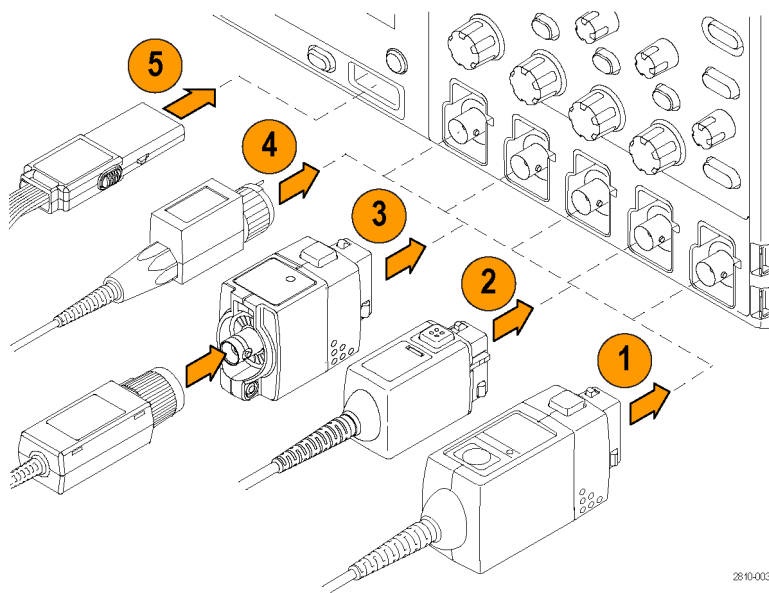

2810-003

For more information on the many probes available for use with MSO4000B and DPO4000B Series oscilloscopes, refer to [www.tektronix.com](http://www.tektronix.com).

## Securing the Oscilloscope

1. Use a standard laptop computer style security lock to secure your oscilloscope to your location.

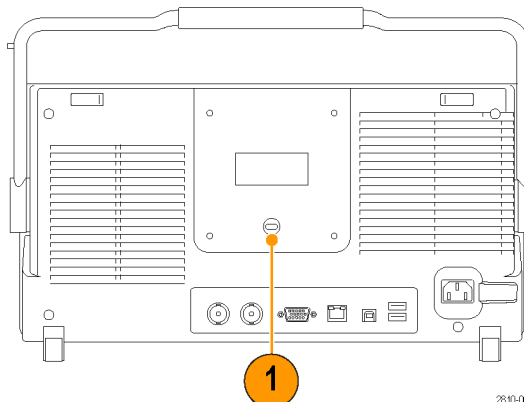

## Powering on the Oscilloscope

### Ground the Oscilloscope and Yourself

To power on the instrument, connect the power cord that was provided with the instrument to the power connector on the rear panel. Connect the power cord to a properly grounded electrical outlet. To power off the instrument, remove the power cord from the instrument.

Grounding the oscilloscope is necessary for safety and to take accurate measurements. The oscilloscope needs to share the same ground as any circuits that you are testing.

If you are working with static sensitive components, ground yourself. Static electricity that builds up on your body can damage static-sensitive components. Wearing a grounding strap safely sends static charges on your body to earth ground.

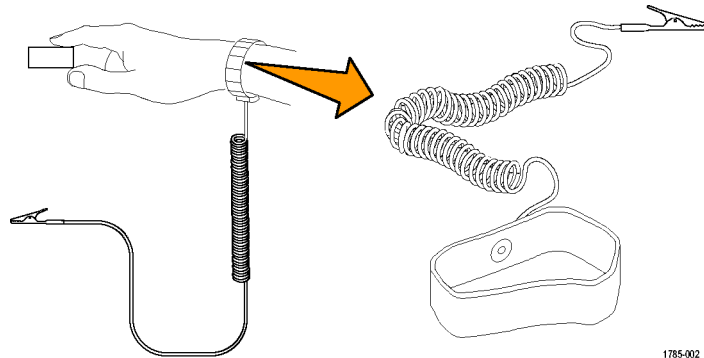

1785-002

To connect the power cord and power on the oscilloscope:

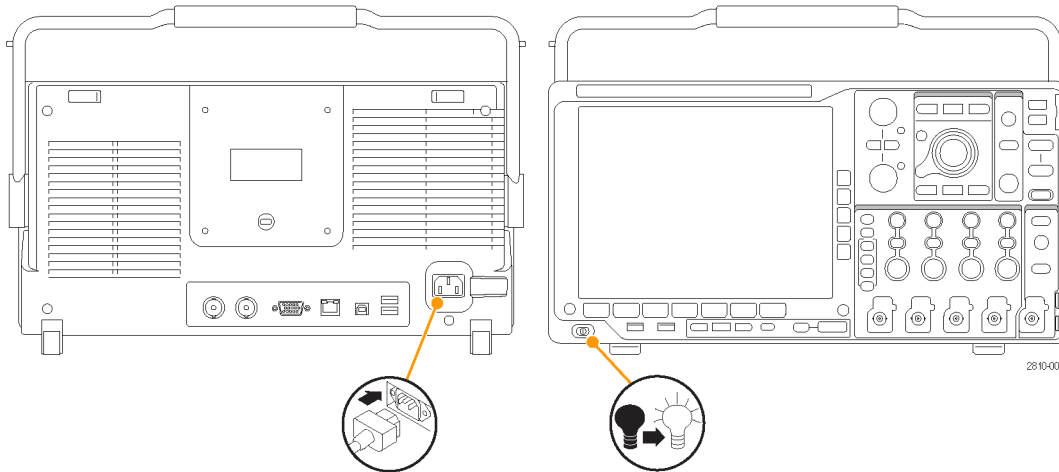

2810-005

## Powering off the Oscilloscope

To power off the oscilloscope and remove the power cord:

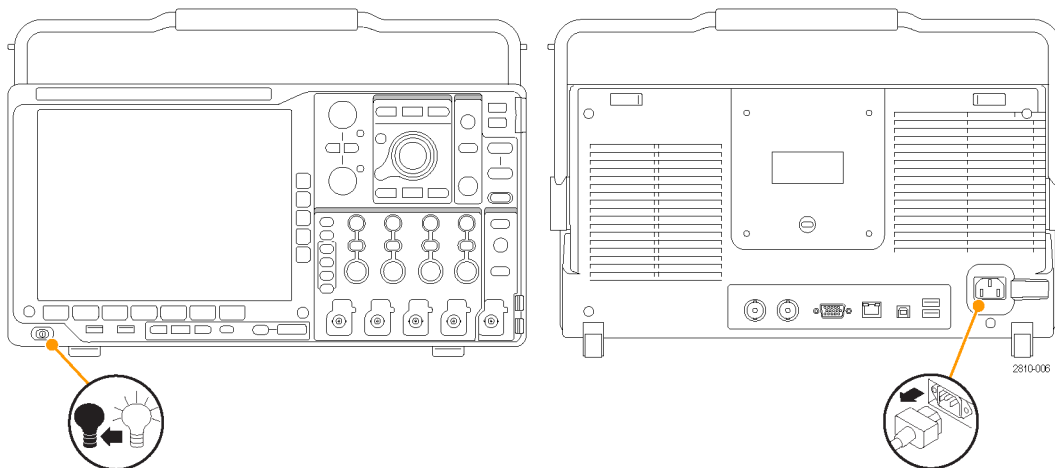

## Functional Check

Perform this quick functional check to verify that your oscilloscope is operating correctly.

1. Connect the oscilloscope power cable as described in *Powering On the Oscilloscope*. (See page 10.)
2. Power on the oscilloscope.

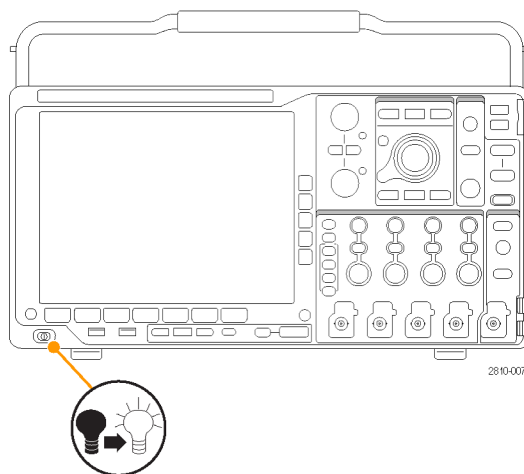

3. Connect the probe connector to oscilloscope channel 1 and the probe tip and reference lead to the **PROBE COMP** terminals on the oscilloscope front panel.

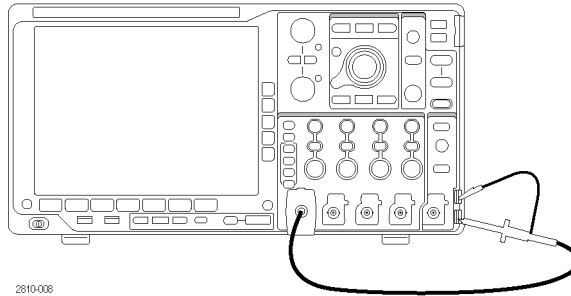

4. Push **Default Setup**.

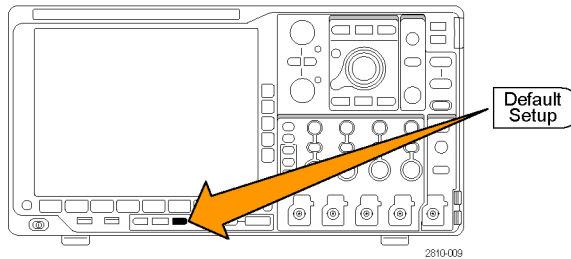

5. Push **Autoset**. The screen should now display a square wave, approximately 2.5 V at 1 kHz.  
 If the signal appears but is misshapen, perform the procedures for compensating the probe. (See page 14, *Compensating a non-TPP0500 or non-TPP1000 Passive Voltage Probe*.)  
 If no signal appears, rerun the procedure.  
 If this does not remedy the situation, have the instrument serviced by qualified service personnel.

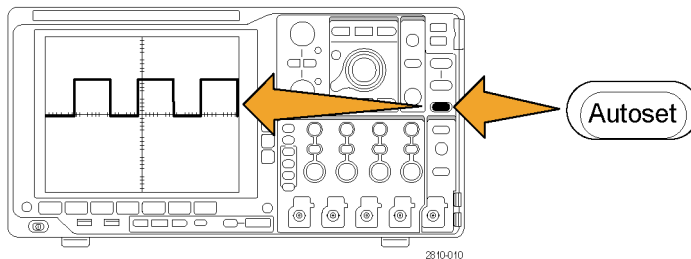

## Compensating a TPP0500 or TPP1000 Passive Voltage Probe

The MSO4000B and DPO4000B can automatically compensate TPP0500 and TPP1000 probes. This eliminates the need for manual probe compensation, as is typically performed with other probes.

Each compensation generates values for a specific probe and channel combination. If you want to use the probe on another channel and desire to compensate the new probe-channel pair, you must run a new set of compensation steps for that new combination.

1. Connect the oscilloscope power cable as described in (See page 10, *Powering on the Oscilloscope*.)
2. Power on the oscilloscope.

- Connect the probe connector to the oscilloscope channel and the probe tip and reference lead to the **PROBE COMP** terminals on the oscilloscope front panel.

**NOTE.** Connect only one probe at a time to the probe comp terminals.

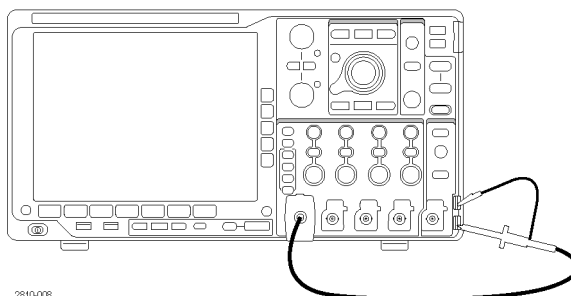

- Push a front-panel button for an input channel connected to the probe you wish to compensate. (1, 2, 3, or 4)

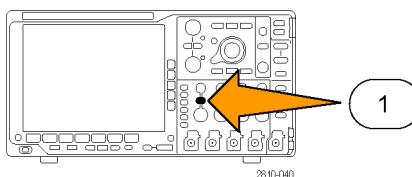

- Notice on the lower menu that the oscilloscope has automatically set the probe termination value

Coupling	Termination set by TPP1000	Invert	Bandwidth	Label		More
DC AC		On  Off	Full			

5

6

- Push **More** repeatedly to select **Probe Setup** from the resulting pop-up menu.

7. Notice that the compensation status starts as **Default**.
8. Push **Compensate probe** and follow the instructions that appear on the display.

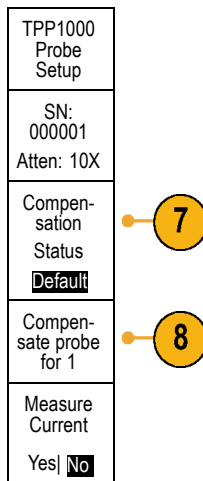

When compensating TPP0500/TPP1000 probes on the MSO/DPO4000B oscilloscopes:

- Each compensation generates values for a specific probe and channel combination. If you want to use the probe on another channel and desire to compensate the new probe-channel pair, you must run a new set of compensation steps.
- Each channel can store compensation values for 10 individual probes. If you try to compensate an 11th probe on a channel, the oscilloscope will delete the values for the least recently used probe and add the values for the new probe.
- The oscilloscope will assign default compensation values to a TPP0500 or TPP1000 probe connected to the **Aux In** channel.

---

**NOTE.** A factory calibration will delete all stored compensation values

---



---

**NOTE.** A probe compensation failure is most likely due to intermittent connection of the probe tip or ground connection during the probe compensation operation. If a failure occurs, the oscilloscope will re-use the old probe compensation values, if they existed prior to the failed probe compensation operation.

---

## Compensating a non-TPP0500 or non-TPP1000 Passive Voltage Probe

Whenever you attach a passive voltage probe for the first time to any input channel, compensate the probe to match it to the corresponding oscilloscope input channel.

If you are interested in using the automatic probe compensation procedure described above for the TPP0500 and TPP1000 probes (See page 12, *Compensating a TPP0500 or TPP1000 Passive Voltage Probe.*) on a non-TPP0500/TPP1000 Tektronix passive probe, check the instruction manual for your probe to see if it qualifies. Otherwise, to properly compensate your passive probe:

1. Follow the steps for the functional check. (See page 11, *Functional Check.*)



2. Check the shape of the displayed waveform to determine if your probe is properly compensated.
3. If necessary, adjust your probe. Repeat as needed.

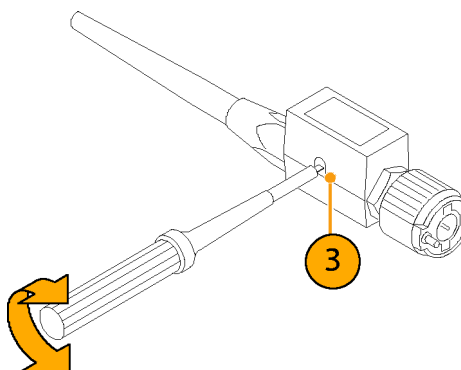

1785-140

### Quick Tips

Use the shortest possible ground lead and signal path to minimize probe-induced ringing and distortion on the measured signal.

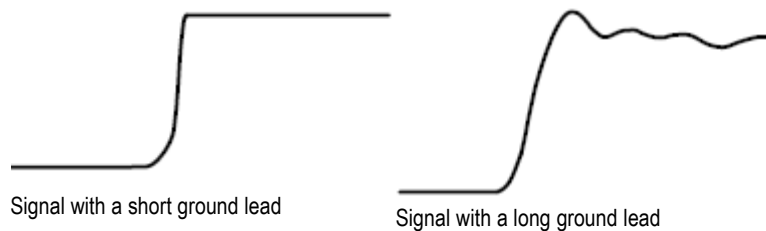

## Application Module Free Trial

A 30-day free trial is available for all application module licenses not installed in your oscilloscope. The trial period begins when you power on the oscilloscope for the first time.

After 30 days, you must purchase the module if you want to continue using the application. To see the date when your free trial period expires, push the front panel **Utility** button, push the lower-bezel **Utility Page** button, use multipurpose knob **a** to select **Config**, and push the lower-bezel **About** button.

## Installing an Application Module



**CAUTION.** To avoid damage to the oscilloscope or application module, observe ESD (electrostatic discharge) precautions. (See page 10, *Powering on the Oscilloscope.*)

Turn off the oscilloscope power while removing or adding an application module.

(See page 11, *Powering off the Oscilloscope.*)

Optional application module packages extend the capability of your oscilloscope.

You can physically install up to four application modules at one time. Application modules go into the two slots with windows in the upper right corner of the front panel. Two additional slots are directly behind the two that you can see. To use these slots, install the module with the label facing away from you.

Each module has a license, which you can optionally transfer between your application modules and oscilloscope. You can keep each license in the module, which will allow you to move the module from one instrument to another.

Alternatively, you can move the license from the module to the oscilloscope. This approach will allow you to store the module separately from the oscilloscope for safe keeping. This approach will also allow you to use more than four applications on your oscilloscope simultaneously.

To transfer a license from a module to your oscilloscope or from your oscilloscope to a module:

1. Turn off the power to the oscilloscope. Insert the application modules in the oscilloscope. Turn on the power.
2. Push the front-panel **Utility** button. If needed, push the lower-menu **Utility Page** button and turn multipurpose knob **a** to select **Config**. Push the lower menu **Application Module Licenses** button and the appropriate side-menu buttons to transfer the license from the module to the oscilloscope or from the oscilloscope to the module. Transfer up to four licenses at one time.
3. After you turn off the power to the oscilloscope, you can remove the physical application module from the oscilloscope.

Refer to the *Tektronix 4000 Series Oscilloscopes Application Module Installation Instructions* that came with your application module for instructions on installing and testing an application module.

---

**NOTE.** If you transfer a license from a module to an oscilloscope, the module will not work on another oscilloscope until you transfer the license back from the oscilloscope to the module. Consider putting the physical module in an envelope or other storage with a label with the date, the module name, and the model and serial number of the oscilloscope, which holds its license. This will help prevent trouble later if someone finds the module, installs it in some other oscilloscope, and wonders why it does not work.

---

## Changing the Language of the User Interface or Keyboard

To change the language of the oscilloscope user interface or keyboard, and to change the front-panel button labels through the use of an overlay:

1. Push **Utility**.

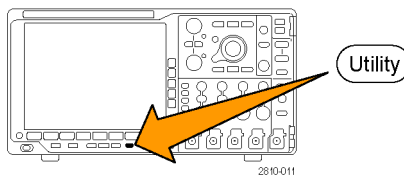

2. Push **Utility Page**.



3. Turn multipurpose knob **a** and select **Config**.

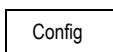

4. Push **Language** from the resulting lower-bezel menu.

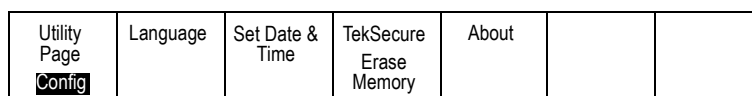

5. Push **Menus** from the resulting side menu and turn multipurpose knob **a** to select the desired language for the user interface.

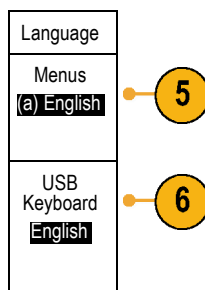

6. Push **USB Keyboard** from the resulting side menu and turn multipurpose knob **a** to select the desired language version of keyboard to use.

7. If you choose to use an English user interface, be sure that the plastic front-panel overlay is removed.

If you choose a language other than English, place the plastic overlay for the language that you desire over the front panel to display labels in that language.

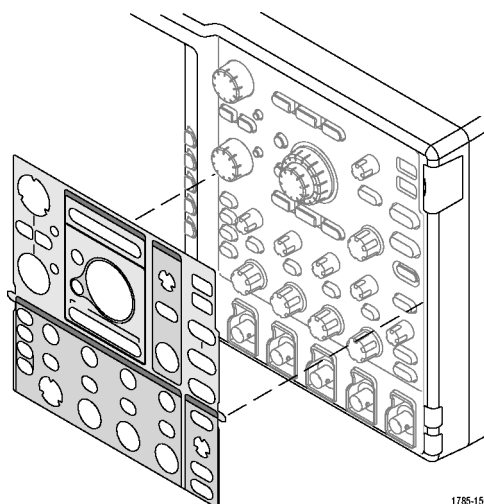

1785-156

## Changing the Date and Time

To set the internal clock with the current date and time:

1. Push **Utility**.

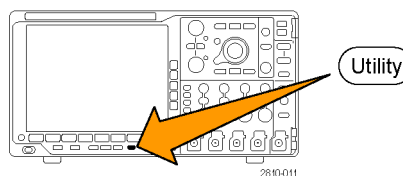

2810-011

2. Push **Utility Page**.



3. Turn multipurpose knob **a** and select **Config**.

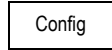

4. Push **Set Date & Time**.

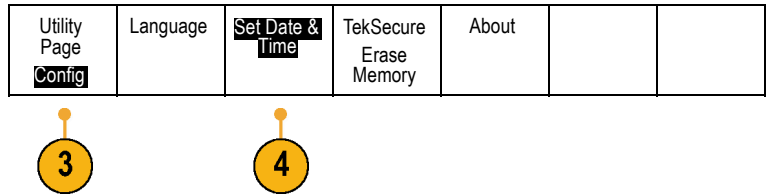

5. Push the side-bezel buttons and turn both multipurpose knobs (**a** and **b**) to set the time and date values.

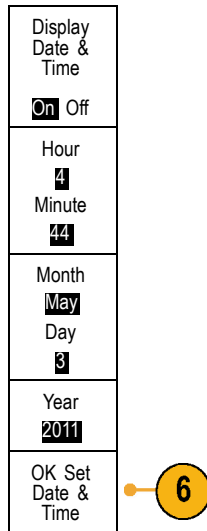

6. Push **OK Set Date & Time**.

## Signal Path Compensation

Signal Path Compensation (SPC) corrects for DC inaccuracies caused by temperature variations and/or long-term drift. Run the compensation whenever the ambient temperature has changed by more than 10 °C (18 °F) or once a week if you use vertical settings of 5 mV/division or less. Failure to do so may result in the instrument not meeting warranted performance levels at those volts/div settings.

To compensate the signal path:

1. Warm up the oscilloscope for at least 20 minutes. Remove all input signals (probes and cables) from channel inputs. Input signals with AC components adversely affect SPC.

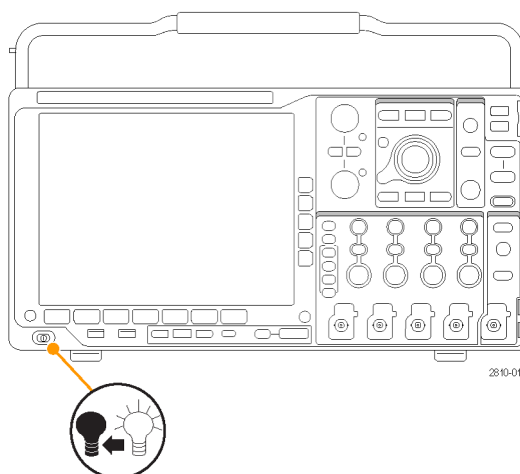

2. Push **Utility**.

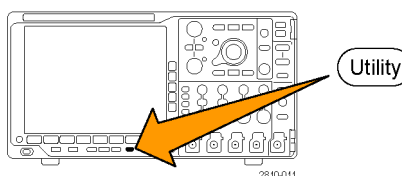

3. Push **Utility Page**.

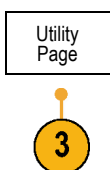

4. Turn multipurpose knob **a** and select **Calibration**.

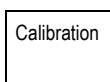

5. Push **Signal Path** from the lower-bezel menu.

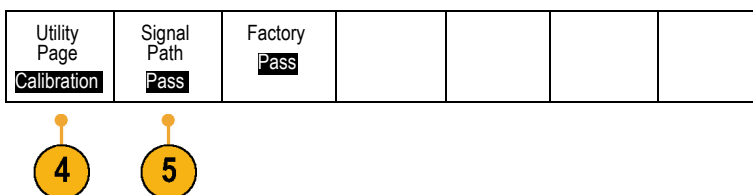

6. Push **OK Compensate Signal Paths** from the resulting side-bezel menu.

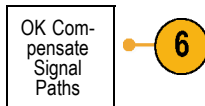

The calibration will take approximately 10 minutes to complete.

7. After calibration, verify that the status indicator on the lower-bezel menu displays **Pass**.

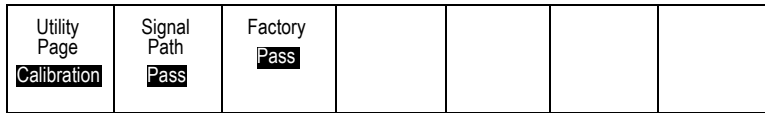

If it does not, then recalibrate the instrument or have the instrument serviced by qualified service personnel.



Service personnel use the factory calibration functions to calibrate the internal voltage references of the oscilloscope using external sources. Contact your Tektronix field office or representative for assistance with factory calibration.

---

**NOTE.** *Signal Path Compensation does not include calibration to the probe tip. (See page 14, Compensating a non-TPP0500 or non-TPP1000 Passive Voltage Probe.)*

---

## Upgrading Firmware

To upgrade the firmware of the oscilloscope:

1. Open up a Web browser and go to [www.tektronix.com/software](http://www.tektronix.com/software). Proceed to the software finder. Download the latest firmware for your oscilloscope on your PC.

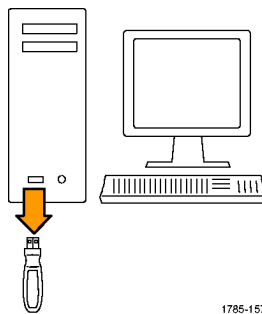

1785-157

Unzip the files and copy the firmware.img file into the root folder of a USB flash drive or USB hard drive.

2. Power off your oscilloscope.

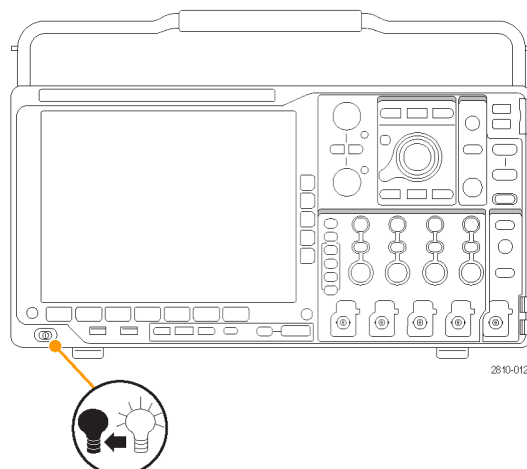

3. Insert the USB flash or hard drive into the front-panel USB port on your oscilloscope.

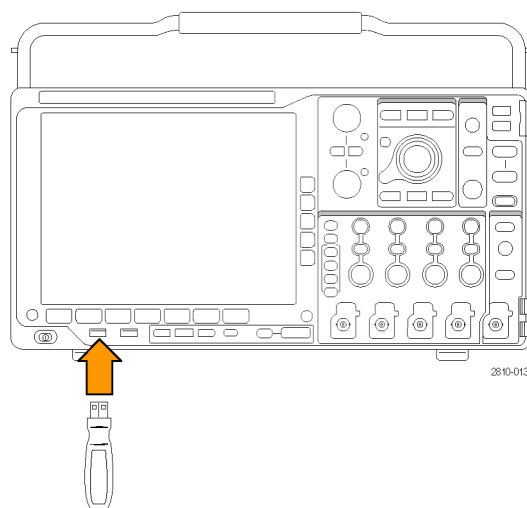

4. Power on the oscilloscope. The instrument automatically recognizes the replacement firmware and installs it.

If the instrument does not install the firmware, rerun the procedure. If the problem continues, try a different model of USB flash or hard drive. Finally, if needed, contact qualified service personnel.

**NOTE.** Do not power off the oscilloscope or remove the USB drive until the oscilloscope finishes installing the firmware.

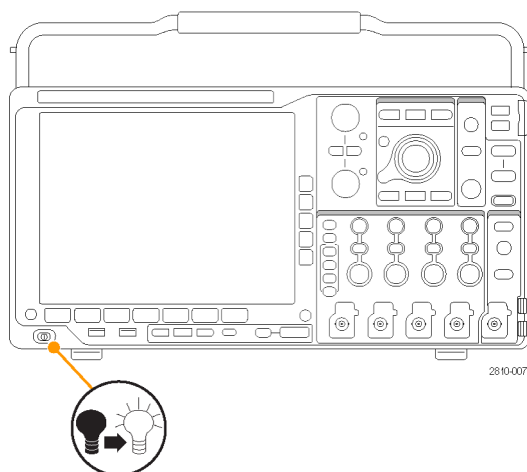

- 5. Power off the oscilloscope and remove the USB flash or hard drive.

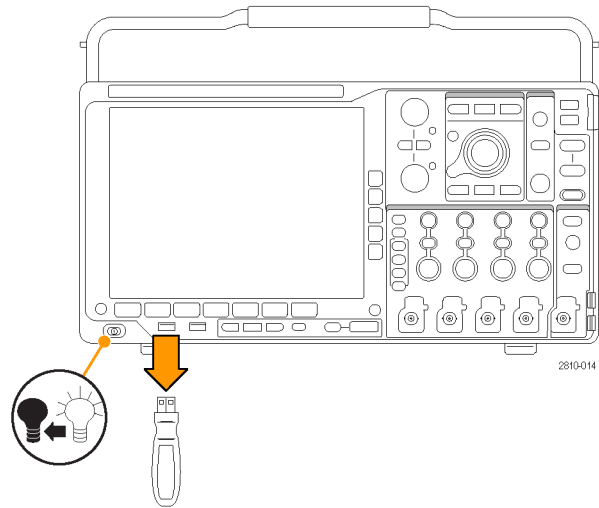

- 6. Power on the oscilloscope.

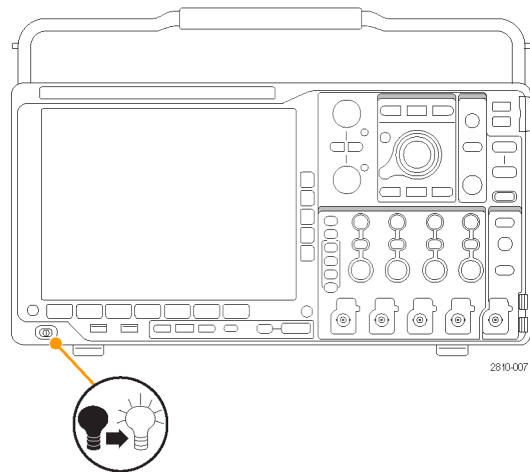

- 7. Push **Utility**.

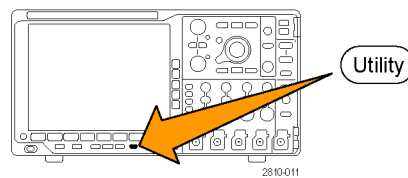

- 8. Push **Utility Page**.

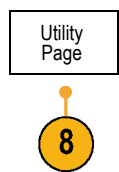

- 9. Turn multipurpose knob **a** and select **Config**.

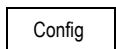



10. Push **About**. The oscilloscope displays the firmware version number.

Utility Page Config	Language English	Set Date & Time	TekSecure Erase Memory	About		
---------------------------	---------------------	--------------------	------------------------------	-------	--	--

11. Confirm that the version number matches that of the new firmware.



## Connecting Your Oscilloscope to a Computer

Connect your oscilloscope directly to a remote computer to let the PC analyze your data, collect screen images, or to control your oscilloscope. (See page 136, *Saving a Screen Image*.) (See page 137, *Saving and Recalling Waveform Data*.)

Two ways to connect your oscilloscope to a computer are through the VISA drivers and the e\*Scope Web-enabled tools. Use VISA to communicate with your oscilloscope from your computer through a software application. Use e\*Scope to communicate with your oscilloscope through a Web browser.

### Using VISA

VISA lets you use your MS-Windows computer to acquire data from your oscilloscope for use in an analysis package that runs on your PC, such as Microsoft Excel, National Instruments LabVIEW, or a program of your own creation. You can use a common communications connection, such as USB, Ethernet, or GPIB, to connect the computer to the oscilloscope.

To set up VISA communications between your oscilloscope and a computer:

1. Load the VISA drivers on your computer.  
You will find the drivers on the appropriate CD that comes with your oscilloscope or at the Tektronix software finder Web page ([www.tektronix.com](http://www.tektronix.com)).
2. Connect the oscilloscope to your computer with the appropriate USB or Ethernet cable.

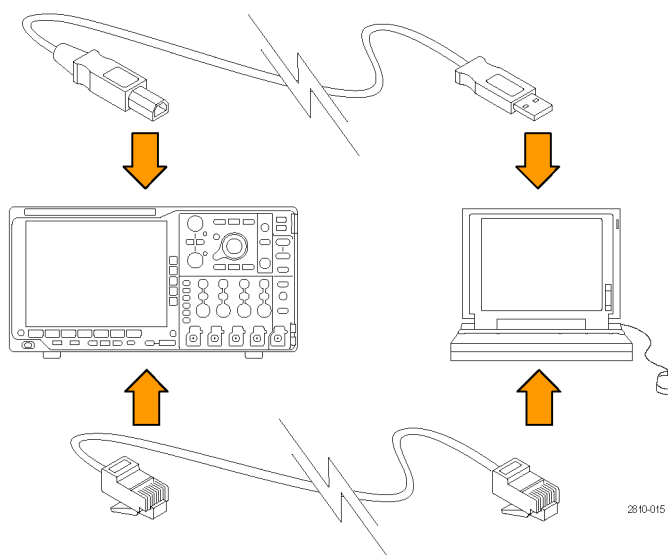

2810-015

To communicate between the oscilloscope and a GPIB system, connect the oscilloscope to the TEK-USB-488 GPIB-to-USB Adapter with a USB cable. Then connect the adapter to your GPIB system with a GPIB cable. Cycle the power on the oscilloscope.

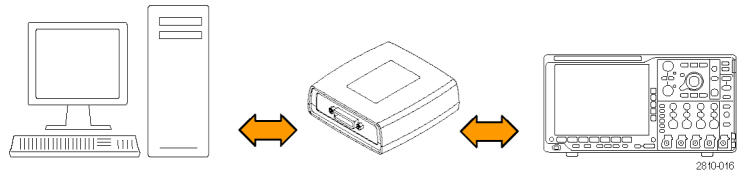

3. Push **Utility**.

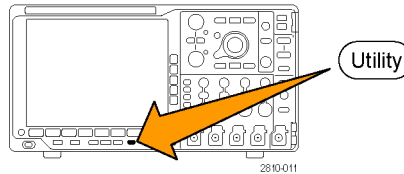

4. Push **Utility Page**.

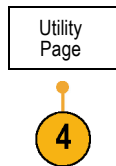

5. Turn multipurpose knob **a** and select **I/O**.

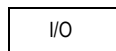

6. If you are using USB, the system sets itself up automatically for you, if USB is enabled.

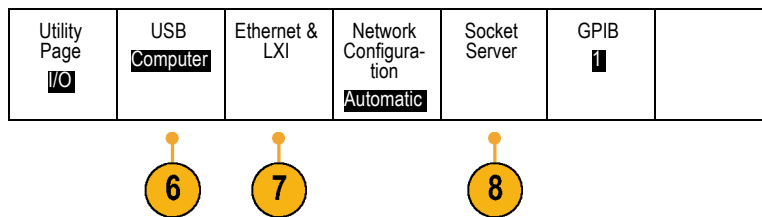

Check **USB** on the lower-bezel menu to be sure that USB is enabled. If it is not enabled, push **USB**. Then push **Connect to Computer** on the side-bezel menu.

7. To use Ethernet, push the **Ethernet & LXI** lower-bezel button.

Use the side-bezel buttons to adjust your network settings, as needed. For more information, see the e\*Scope setup information below.

8. If you want to change socket server parameters, push **Socket Server** and enter new values through the resulting side-bezel menu.

9. If you are using GPIB, push **GPIB**. Enter the GPIB address on the side-bezel menu, using multipurpose knob **a**.

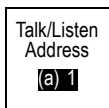

This will set the GPIB address on an attached TEK-USB-488 Adapter.

10. Run your application software on your computer.



## Quick Tips

- Your oscilloscope shipped with a CD that included a variety of Windows-based software tools designed to ensure efficient connectivity between your oscilloscope and your computer. These include toolbars that speed connectivity with Microsoft Excel and Word. There are also two standalone acquisition programs called NI LabVIEW SignalExpress™, Tektronix Edition and Tektronix OpenChoice® Desktop.
- The rear-panel USB 2.0 device port is the correct USB port for computer connectivity. Use the rear- and front-panel USB 2.0 host ports to connect your oscilloscope to USB flash drives. Use the USB Device port to connect your oscilloscope to a PC or a PictBridge printer.

USB Host port



USB Device port



## Using the LXI Web Page and e\*Scope

With e\*Scope, you can access any Internet-connected MSO4000B or DPO4000B Series oscilloscope from a web browser on your computer. No matter where you are, your oscilloscope is as close as the nearest browser.

To set up e\*Scope communications between your oscilloscope and a Web browser running on a remote computer:

1. Connect the oscilloscope to your computer network with an appropriate Ethernet cable.

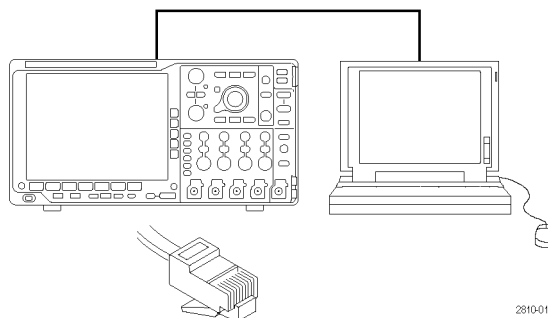

28104017

2. Push **Utility**.

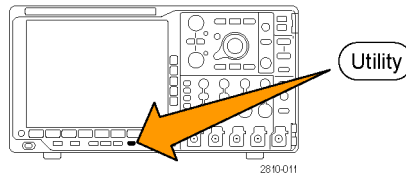

3. Push **Utility Page**.



4. Turn multipurpose knob **a** and select **I/O**.

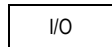

5. Push **Ethernet & LXI**.

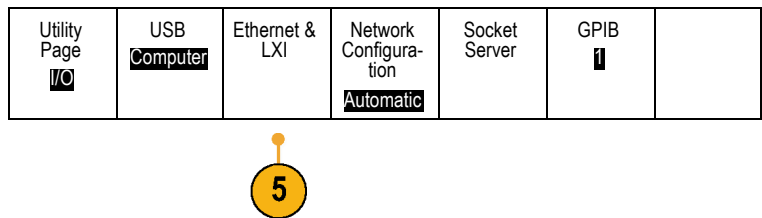

6. View the top side-menu item to determine the condition of the LAN. An indicator turns green for good status and red if the device detects a fault.
7. Push **LAN Settings** to display the network parameters configured on your oscilloscope.
8. Push **LAN Reset** to restore the LAN defaults to your oscilloscope.
9. Push **Test Connection** to check if your oscilloscope can find an attached network.
10. Push to see another page of side-menu items.

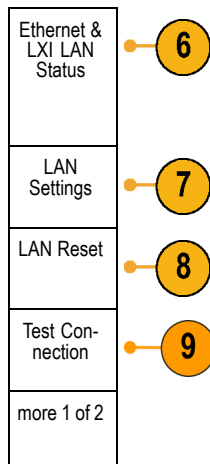

11. Push to change the name of the oscilloscope, the network domain, or the service name.

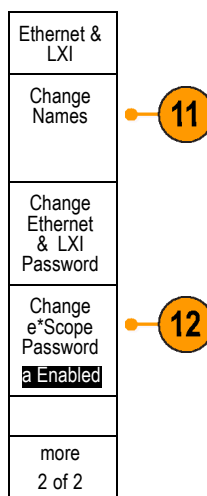

12. Push to use the LXI password to also protect your oscilloscope from changes made to LAN settings from a Web browser.

13. Start your browser on your remote computer. In the browser address line, enter the host name, a dot, and the domain name together. Alternatively, just enter the IP address of the instrument. Either way, you should then see the LXI Welcome page on your Web browser on your computer screen.
14. Click "Network Configuration" to view and edit the network configuration settings. If you are using a password and changing your settings, you may need to know that the default user name is "lxuser".
15. For e\*Scope, click the Instrument Control (e\*Scope) link on the left side of the LXI Welcome page. You should then see a new tab (or window) open in your browser with e\*Scope running.

## Connecting a USB Keyboard to Your Oscilloscope

You can connect a USB keyboard to a USB Host port on the rear or front panel of the oscilloscope. The oscilloscope will detect the keyboard, even if it is plugged in while the oscilloscope is powered on.

You can use the keyboard to quickly create names or labels. You can bring up the Label menu through the lower-bezel label button of the Channel or Bus menus. Use the arrow keys on the keyboard to move the insertion point, and then type in a name or label. Labeling channels and buses makes the information on the screen easier to identify.

To choose whether to use a keyboard with a United States (US) key layout or one with an alternative layout.

1. Push **Utility**.

- 2. Push **Utility Page**.

Utility Page <b>Config</b>	Language English	Set Date & Time	TekSecure Erase Memory	About		
-------------------------------	---------------------	--------------------	------------------------------	-------	--	--

- 3. Turn multipurpose knob **a** and select **Config**.



- 4. Push **Language** from the resulting lower-bezel menu.
- 5. Push **USB Keyboard** from the resulting side menu.
- 6. Turn multipurpose knob **a** and select the desired keyboard layout style from the resulting menu.

# Get Acquainted with the Instrument

## Front-Panel Menus and Controls

The front panel has buttons and controls for the functions that you use most often. Use the menu buttons to access more specialized functions.

### Using the Menu System

To use the menu system:

1. Push a front-panel menu button to display the menu that you want to use.

**NOTE.** The **B1** through **B4** buttons support up to four different serial or parallel buses.

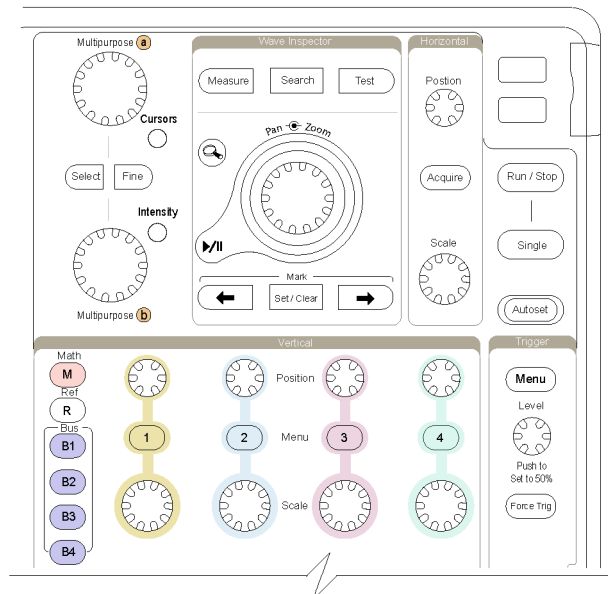

2. Push a lower-bezel button to select a menu item. If a pop-out menu appears, turn multipurpose knob **a** to select the desired choice. If a pop-up menu appears, push the button again to select the desired choice.

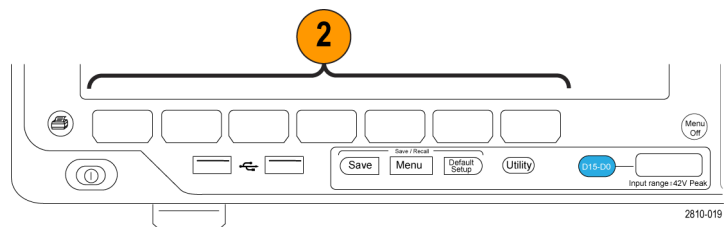

3. Push a side-bezel button to choose a side-bezel menu item.  
If the menu item contains more than one choice, push the side-bezel button repeatedly to cycle through the choices.  
If a pop-out menu appears, turn multipurpose knob **a** to select the desired choice.

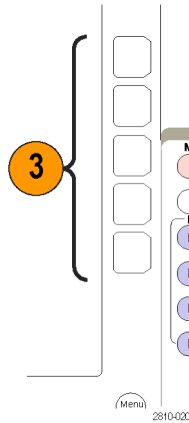

4. To remove a side-bezel menu, push the lower-bezel button again or push **Menu Off**.

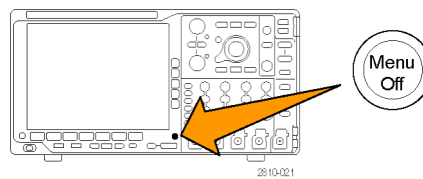



5. Certain menu choices require you to set a numeric value to complete the setup. Use the upper and lower multipurpose knobs **a** and **b** to adjust values.
6. Push **Fine** to turn off or on the ability to make smaller adjustments.

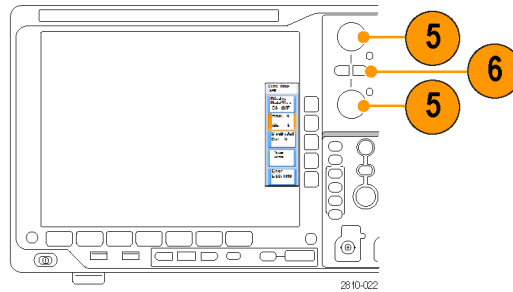

### Using the Menu Buttons

Use the menu buttons to perform many functions in the oscilloscope.

1. **Measure.** Push to perform automated measurements on waveforms.
2. **Search.** Push to perform an automated search through an acquisition for user-defined events/criteria.
3. **Test.** Push to activate advanced or application-specific testing features.
4. **Acquire.** Push to set the acquisition mode and adjust the record length.
5. **Autoset.** Push to perform an automatic setup of oscilloscope settings.

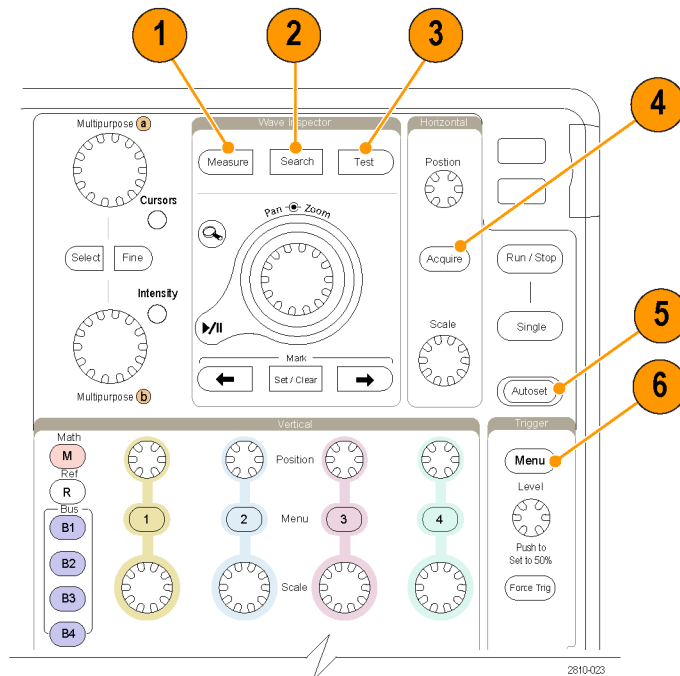

6. **Trigger Menu.** Push to specify trigger settings.

7. **Utility.** Push to activate the system utility functions, such as selecting a language or setting the date/time.

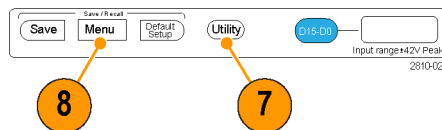

8. **Save / Recall Menu.** Push to save and recall setups, waveforms, and screen images to internal memory, a USB flash drive, or a mounted network drive.
9. **Channel 1,2,3, or 4 Menu.** Push to set vertical parameters for input waveforms and to display or remove the corresponding waveform from the display.

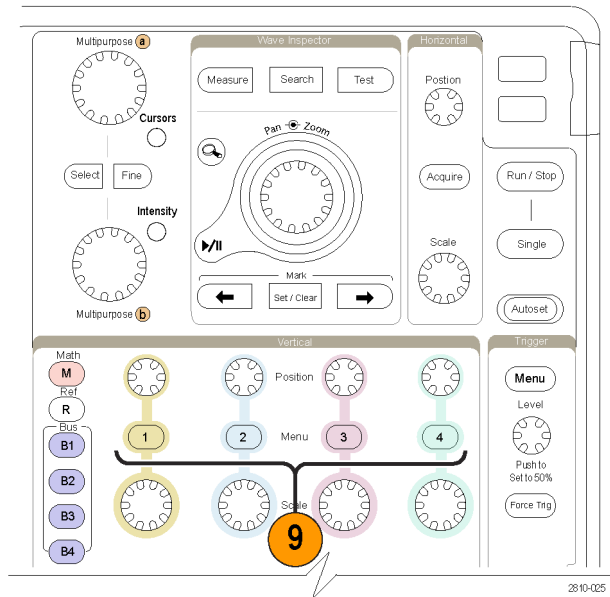

10. **B1, B2, B3, or B4.** Push to define and display a bus if you have the appropriate module application keys.

- DPO4AERO supports MIL-STD-1553 buses.
- DPO4AUTO supports CAN and LIN buses.
- DPO4AUTOMAX supports CAN, LIN, and FlexRay buses.
- DPO4EMBD supports I<sup>2</sup>C and SPI buses.
- DPO4ENET supports Ethernet buses.
- DPO4USB supports USB 2.0 buses.
- DPO4COMP supports RS-232, RS-422, RS-485, and UART buses.
- DPO4AUDIO supports I<sup>2</sup>S, Left Justified (LJ), Right Justified (RJ), and TDM buses.

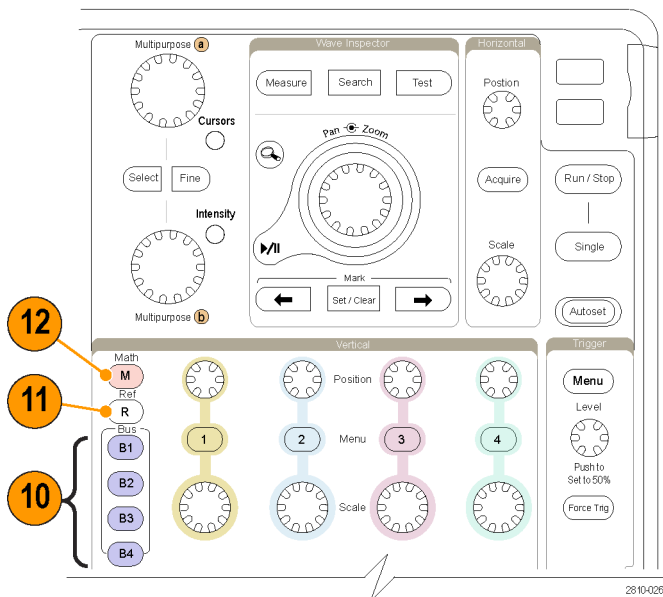

Also, push the **B1, B2, B3, or B4** button to display or remove the corresponding bus from the display.

11. **R.** Push to manage reference waveforms, including the display or removal of each reference waveform from the display.
12. **M.** Push to manage the math waveform, including the display or removal of the math waveform from the display.

## Using Other Controls

These buttons and knobs control waveforms, cursors, and other data input.

1. Turn the upper multipurpose knob **a**, when activated, to move a cursor, to set a numerical parameter value for a menu item, or to select from a pop-out list of choices. Push the **Fine** button to toggle between coarse and fine adjustment. Screen icons tell you when **a** or **b** are active.

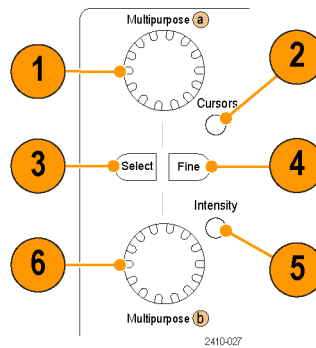

2. **Cursors.** Push once to turn the cursors on. When the cursors are on, you can turn the multipurpose knobs to control their position. Push again to turn them off.

Push and hold to show the cursor menu and configure the cursors. Push **Menu Off** when done to return control of the cursors to the multipurpose knobs.

3. **Select.** Push to activate special functions.

For example, when using the two vertical cursors (and no horizontal ones are visible), you can push this button to link or unlink the cursors. When the two vertical and two horizontal cursors are both visible, you can push this button to make either the vertical cursors or the horizontal cursors active.

You also can use the **Select** button with the file system operations.

4. **Fine**. Push to toggle between making coarse and fine adjustments with the vertical and horizontal position knobs, the trigger level knob, and many operations of multipurpose knobs **a** and **b**.
5. Waveform **Intensity**. Push to enable multipurpose knob **a** to control waveform display intensity and knob **b** to control graticule intensity.
6. Turn the lower multipurpose knob **b**, when activated, to move a cursor or set a numerical parameter value for a menu item. Push **Fine** to make adjustments more slowly.
7. **Zoom** button. Push to activate zoom mode.
8. **Pan** (outer knob). Turn to scroll the zoom window through the acquired waveform.
9. **Zoom** (inner knob). Turn to control the zoom factor. Turning it clockwise zooms in further. Turning it counterclockwise zooms out.

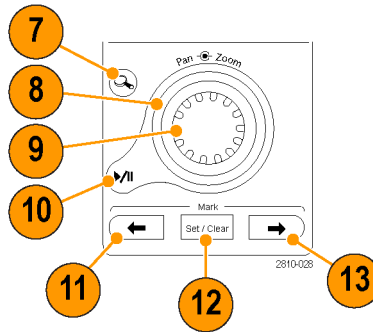

10. **Play-pause** button. Push to start or stop the automatic panning of a waveform. Control the speed and direction with the pan knob.
11. ← **Prev**. Push to jump to the previous waveform mark.
12. **Set/Clear Mark**. Push to establish or delete a waveform mark.
13. → **Next**. Push to jump to the next waveform mark.

**14. Horizontal Position.** Turn to adjust the trigger point location relative to the acquired waveforms. Push **Fine** to make smaller adjustments.

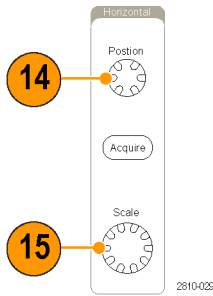

**15. Horizontal Scale.** Turn to adjust the horizontal scale (time/division).

**16. Run/Stop.** Push to start or stop acquisitions.

**17. Single.** Push to make a single acquisition.

**18. Autoset.** Push to automatically set the vertical, horizontal, and trigger controls for a usable, stable display.

**19. Trigger Level.** Turn to adjust the trigger level. Push to set the trigger level to the midpoint of the waveform.

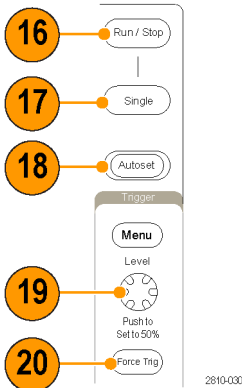

**20. Force Trig.** Push to force an immediate trigger event.

**21. Vertical Position.** Turn to adjust the vertical position of the corresponding waveform. Push **Fine** to make smaller adjustments.

**22. 1, 2, 3, 4.** Push to display or remove the corresponding waveform from the display and access the vertical menu.

**23. Vertical Scale.** Turn to adjust the vertical scale factor of the corresponding waveform (volts/division).

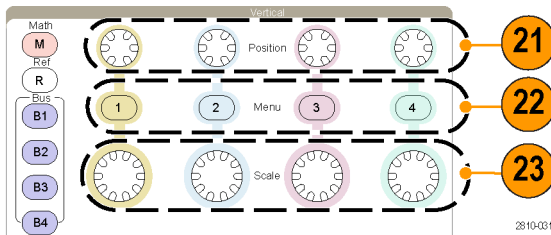

**24. Print.** Push to print a screen image using the printer selected in the Utility menu. (See page 143, *Printing a Hard Copy.*)

**25. Power switch.** Push to power on or off the instrument.

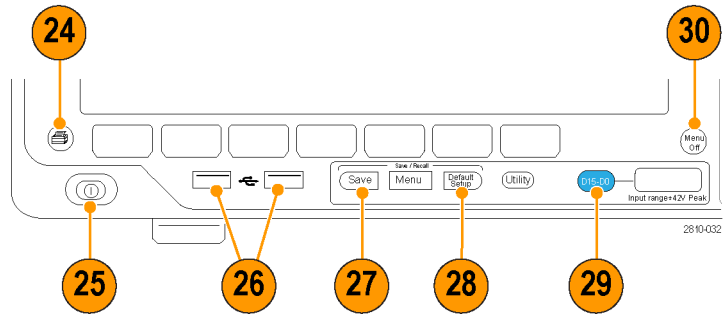

**26. USB 2.0 host ports.** Insert a USB cable here to connect peripherals to the oscilloscope, such as a keyboard, a printer, or a flash drive. There are two more USB 2.0 host ports on the rear panel.

**27. Save.** Push to perform an immediate save operation. The save operation uses the current save parameters, as defined in the Save / Recall menu.

**28. Default Setup.** Push to perform an immediate restore of the oscilloscope to the default settings.

**29. D15 - D0.** Push to display or remove the digital channels from the display, and to access the digital channel setup menu (MSO4000B Series only).

- 30. Menu Off.** Push to clear a displayed menu from the screen.

### Identifying Items in the Display

The items shown to the right may appear in the display. Not all of these items are visible at any given time. Some readouts move outside the graticule area when menus are turned off.

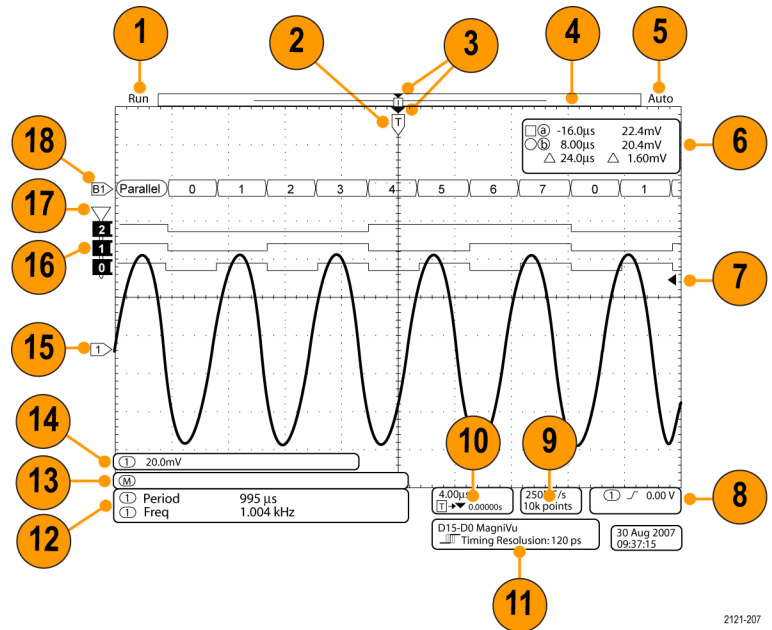

2121-207

- The acquisition readout shows when an acquisition is running, stopped, or when acquisition preview is in effect. Icons are:
  - Run: Acquisitions enabled
  - Stop: Acquisitions not enabled
  - Roll: In roll mode (40 ms/div or slower)
  - PreVu: In this state, the oscilloscope is stopped or between triggers. You can change the horizontal or vertical position or scale to see approximately what the next acquisition will look like.

- The trigger position icon shows the trigger position in the acquisition.

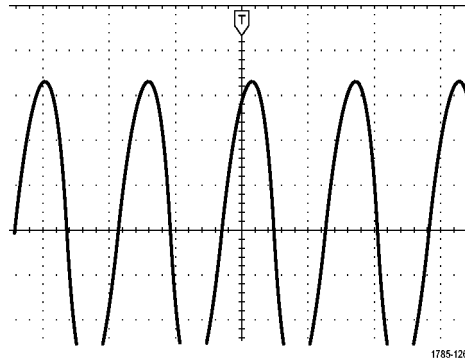

- The expansion point icon (an orange triangle) shows the point that the horizontal scale expands and compresses around.

To make the expansion point the same as the trigger point, push **Acquire** and set the lower-menu **Delay** item to **Off**.

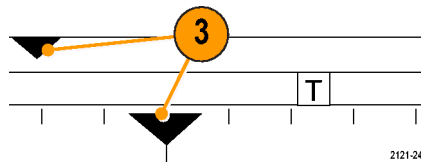

- The waveform record view shows the trigger location relative to the waveform record. The line color corresponds to the selected waveform color.

The brackets show the part of the record currently displayed on the screen.

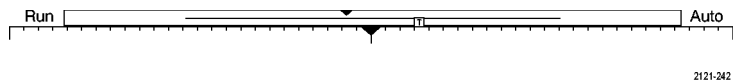

- The trigger status readout shows trigger status. Status conditions are:

- PrTrig: Acquiring pretrigger data
- Trig?: Waiting for trigger
- Trig'd: Triggered
- Auto: Acquiring untriggered data

- The cursor readout shows time, amplitude, and delta ( $\Delta$ ) values for each cursor.

For FFT measurements, it shows frequency and magnitude.

For serial buses, the readout shows the decoded values.

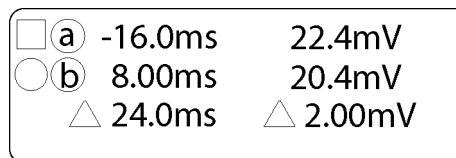

(See page 108, *Taking Manual Measurements with Cursors*.)



7. The trigger level icon shows the trigger level on the waveform. The icon color corresponds to the trigger source color.

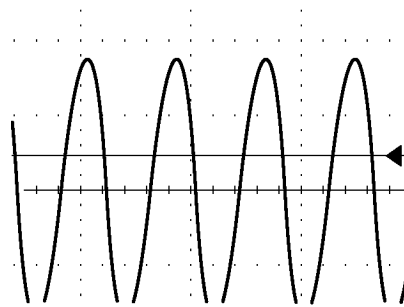

1785-143

8. The trigger readout shows the trigger source, slope, and level. The trigger readouts for other trigger types show other parameters.

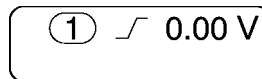

1785-135

9. The top line of the record length/sampling rate readout shows the sampling rate. You can adjust it with the **Horizontal Scale** knob. The bottom line shows the record length. You can adjust it by pushing **Acquire** and the **Record Length** item in the resulting lower-bezel menu.

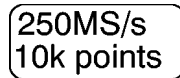

1785-137

10. The horizontal position/scale readout shows on the top line the horizontal scale (adjust with the **Horizontal Scale** knob).

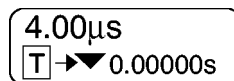

1785-136

With **Delay Mode** on, the bottom line shows the time from the T symbol to the expansion point icon (adjust with the **Horizontal Position** knob).

Use horizontal position to insert added delay between when the trigger occurs and when you actually capture the data. Insert a negative time to capture more pretrigger information.

With **Delay Mode** off, the bottom line shows the time location of the trigger within the acquisition, as a percentage.

11. The Timing Resolution readout shows the timing resolution of the digital channels.

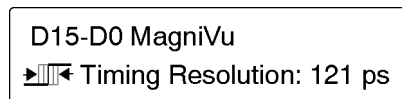

2121-208

Timing resolution is the time between samples. It is the reciprocal of the digital sample rate.

When the MagniVu control is on, "MagniVu" appears in the readout.

12. Measurement readouts show the selected measurements. You can select up to eight measurements to display at one time.



A  symbol appears instead of the expected numerical measurement if a vertical clipping condition exists. Part of the waveform is above or below the display. To obtain a proper numerical measurement, turn the vertical scale and position knobs to make all of the waveform appear in the display.

13. The auxiliary waveform readouts show the vertical and horizontal scale factors of the math and reference waveforms.

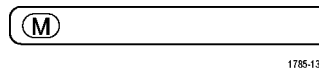

14. The channel readout shows the channel scale factor (per division), coupling, invert, and bandwidth status. Adjust with the **Vertical Scale** knob and in the channel **1, 2, 3, or 4** menus.

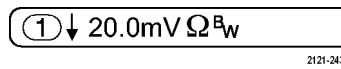

15. For analog channels, the waveform baseline indicator shows the zero-volt level of a waveform, assuming you have not used any offset. The icon colors correspond to the waveform colors.

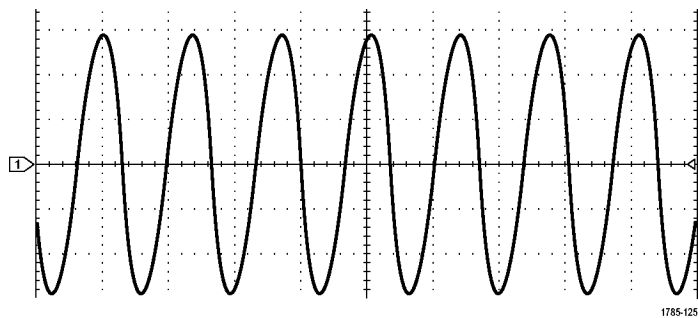

16. For digital channels (MSO4000B Series only), the baseline indicators point to the high and low levels. The indicator colors follow the color code used on resistors. The D0 indicator is black, the D1 indicator is brown, the D2 indicator is red, and so on.

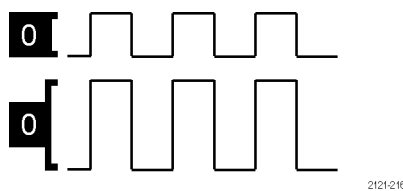

17. The group icon indicates when digital channels are grouped (MSO4000B Series only).

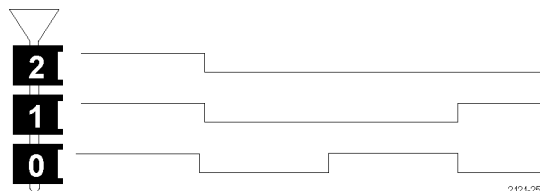

- The bus display shows decoded packet level information for serial buses or for parallel buses (MSO4000B Series only). The bus indicator shows the bus number and bus type.

## Front-Panel Connectors

- Logic Probe Connector (on MSO4000B models only)
- Channel 1, 2, 3, 4. Channel inputs with TekVPI Versatile Probe Interface.
- Aux In.** Trigger level range is adjustable from +8 V to -8 V. The maximum input voltage is  $400 V_{\text{peak}}$ ,  $250 V_{\text{RMS}}$ . Input resistance is  $1 M\Omega \pm 1\%$  in parallel with  $13 \text{ pF} \pm 2 \text{ pF}$ .
- PROBE COMP.** Square wave signal source to compensate or calibrate probes. Output voltage: 0 – 2.5 V, amplitude  $\pm 1\%$  behind  $1 \text{ k}\Omega \pm 2\%$ . Frequency: 1 kHz.
- Ground.
- Application Module Slots.

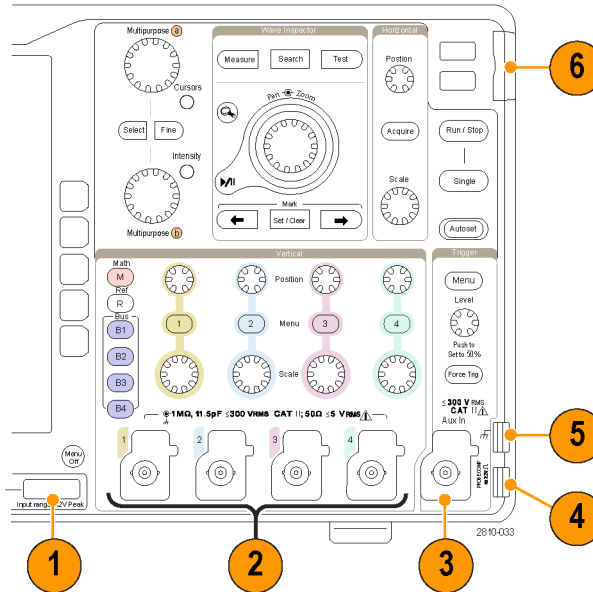

## Side-Panel Connector

- Ground strap connector. This is a receptacle for a grounding strap.



## Rear-Panel Connectors

1. **Auxiliary Output.** Use this output to generate a signal on a main trigger pulse, as a 10 MHz reference signal, or to output a signal when other events happen, such as mask-limit test events.

To use this to synchronize other test equipment with your oscilloscope, push the front-panel **Utility** button, the bottom-bezel **Utility Page** button, and select **External Signals** with multipurpose knob **a**. Push **AUX OUT** from the bottom-bezel menu and **Main Trigger** from the resulting side menu.

A LOW to HIGH transition indicates that the trigger occurred. The logic level for  $V_{out} (HI)$  is  $\geq 2.5$  V open circuit;  $\geq 1.0$  V into a  $50\Omega$  load to ground. The logic level for  $V_{out} (LO)$  is  $\leq 0.7$  V into a load of  $\leq 4$  mA;  $\leq 0.25$  V into a  $50\Omega$  load to ground.

2. **EXT REF IN.** You can connect an external clock to this connector. To enable this connector, push the front-panel **Utility** button, the bottom-bezel **Utility Page** button, and select **External Signals** with multipurpose knob **a**. Push **Reference Source** from the bottom-bezel menu and **EXT REF IN** from the resulting side menu.
3. **XGA Out.** Use the XGA Video port (DB-15 female connector) to show the oscilloscope display on an external monitor or projector.
4. **LAN.** Use the LAN (Ethernet) port (RJ-45 connector) to connect the oscilloscope to a 10/100 Base-T local area network.  
MSO4000B and DPO4000B models are LXI Class C version 1.3 compliant.

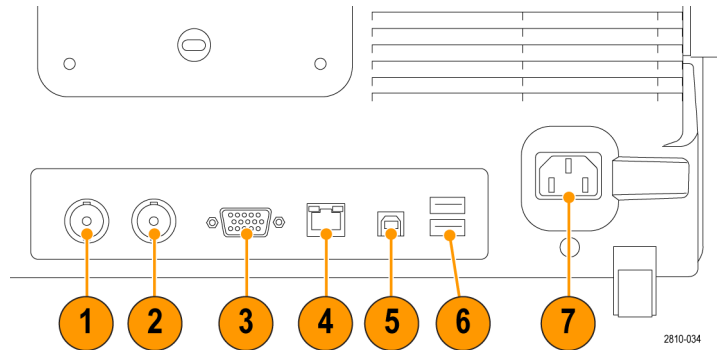

5. **Device.** Use the USB 2.0 High speed device port to control the oscilloscope through USBTMC or GPIB with a TEK-USB-488 Adapter. The USBTMC protocol allows USB devices to communicate using IEEE488 style messages. This lets you run your GPIB software applications on USB hardware. Also, use the USB port to connect a PictBridge-compatible printer to the oscilloscope.
6. **Host.** Use the USB 2.0 high speed host ports (two on the rear-panel and one on the front) to take advantage of USB flash drives and printers.
7. **Power input.** Attach to an AC power line with integral safety ground. (See page 5, *Operating Considerations.*)

# Acquire the Signal

This section describes concepts of and procedures for setting up the oscilloscope to acquire the signal as you want it to.

## Setting Up Analog Channels

Use front-panel buttons and knobs to set up your instrument to acquire signals using the analog channels.

1. Connect the TPP0500/TPP1000 or VPI probe to the input signal source.

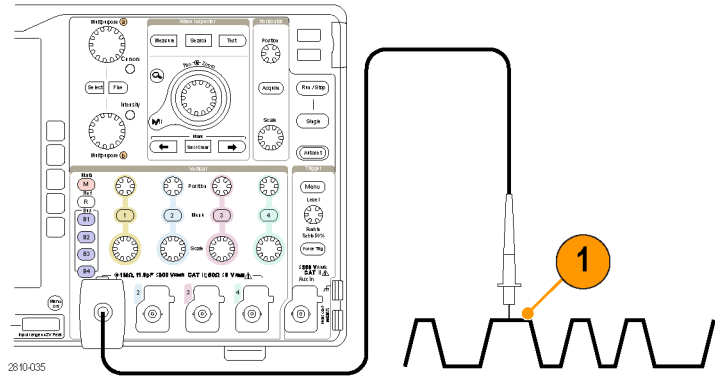

2. Select the input channel by pushing the front-panel buttons.

**NOTE.** If you are using a probe that does not supply probe encoding, set the attenuation (probe factor) on the oscilloscope vertical menu for the channel to match the probe.

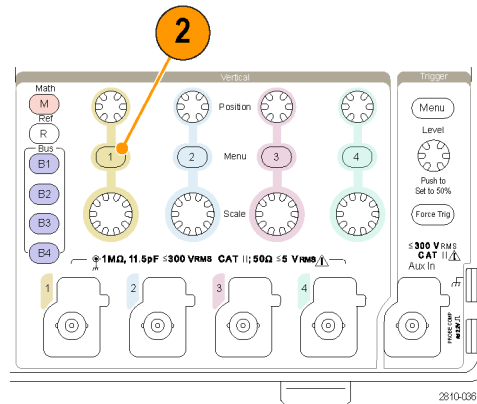

3. Push **Default Setup**.

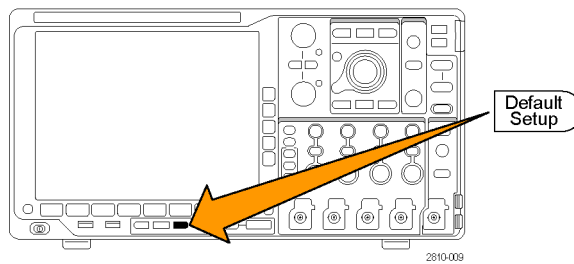

4. Push **Autoset**.

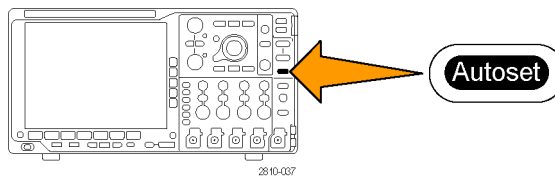

5. Push the desired channel button. Then adjust the vertical position and scale.

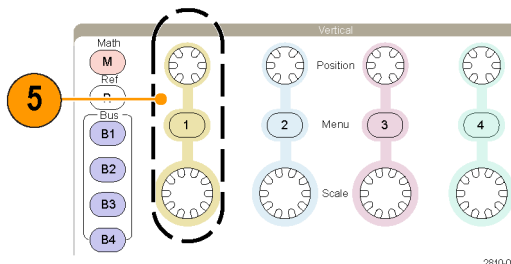

6. Adjust the horizontal position and scale.  
 The horizontal position determines the number of pretrigger and posttrigger samples.  
 The horizontal scale determines the size of the acquisition window relative to the waveform. You can scale the window to contain a waveform edge, a cycle, several cycles, or thousands of cycles.

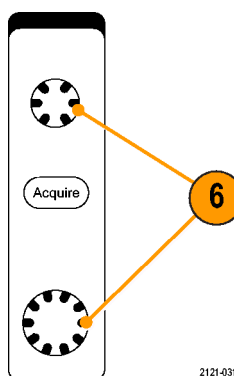

### Quick Tip

- Use the zoom feature to see multiple cycles of your signal in the upper part of the display. (See page 122, *Using Wave Inspector to Manage Long Record Length Waveforms.*)

### Labeling Channels and Buses

You can add a label to the channels and buses shown on the display for easy identification. The label is placed on the waveform baseline indicator in the left side of the screen. The label can have up to 32 characters.

To label a channel, push a channel input button for an analog channel.

1. Push a front panel button for an input channel or a bus.

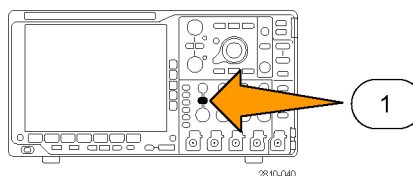

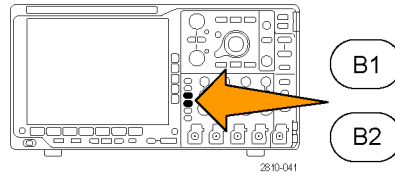

2. Push a lower-bezel button to create a label, such as for channel 1 or B1.

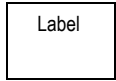

3. Push **Select Preset Label** to view a list of labels.



4. Turn multipurpose knob **b** to scroll through the list to find a suitable label. You can edit the label after you insert it if necessary.

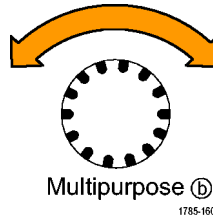

5. Push **Insert Preset Label** to add the label.



If you are using a USB keyboard, use the arrow keys to position the insertion point and edit the inserted label, or type in a new label. (See page 27, *Connecting a USB Keyboard to Your Oscilloscope.*)

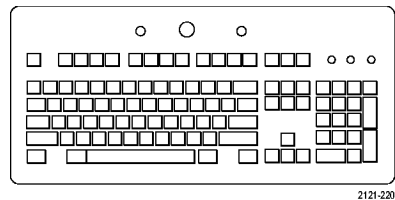

6. If you do not have a USB keyboard connected, push the side- and lower-bezel arrow keys to position the insertion point.

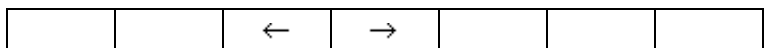
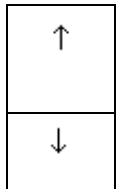



- Turn multipurpose knob **a** to scroll through the list of letters, numbers, and other characters to find the character in the name that you want to enter.

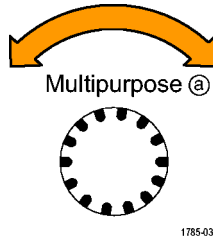

ABCDEFGHIJKLMNOPQRSTUVWXYZ  
 abcdefghijklmnopqrstuvwxyz  
 0123456789\_+!@#\$%^&\*()[]{}<>/~"'\:;.,?`

- Push **Select** or **Enter Character** to let the oscilloscope know that you have picked the proper character to use.

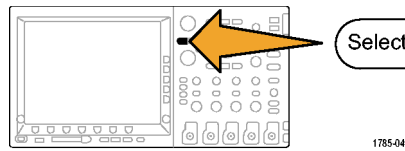

You can use the lower-bezel buttons to edit the label as needed.

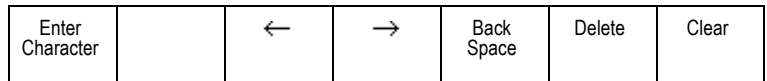

- Continue scrolling and pushing **Select** until you have entered all the desired characters. For another label, push the side- and lower-bezel arrow keys to reposition the insertion point.

- Push **Display Labels** and select **On** to see the label.

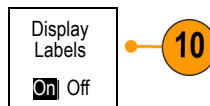

## Using the Default Setup

To return the oscilloscope to its default settings:

- Push **Default Setup**.

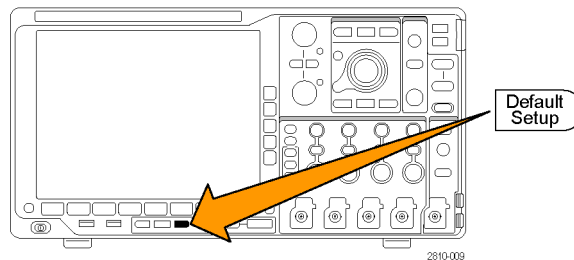

2. If you change your mind, push **Undo Default Setup** to undo the last default setup.

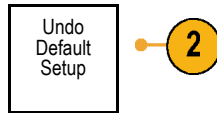

## Using Autoset

Autoset adjusts the instrument (acquisition, horizontal, trigger, and vertical controls) such that it displays four or five waveform cycles for analog channels with the trigger near the midlevel, and ten cycles for digital channels.

Autoset works with both the analog and digital channels.

1. To autoset an analog channel, connect the analog probe, and then select the input channel. (See page 44, *Setting Up Analog Channels*.)

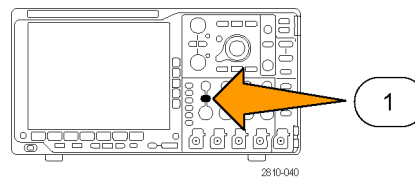

To autoset a digital channel, connect the logic probe and select the input channel. (See page 67, *Setting Up Digital Channels*.)

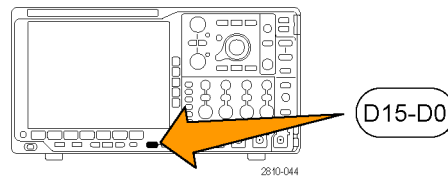

2. Push **Autoset** to execute an Autoset.

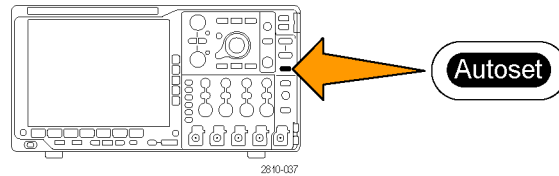

3. If desired, push **Undo Autoset** to undo the last Autoset.



You can also disable the Autoset function. To disable or enable the Autoset function:

1. Push and hold **Autoset**.

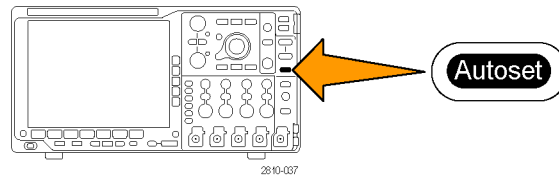

2. Push and hold **Menu Off**.

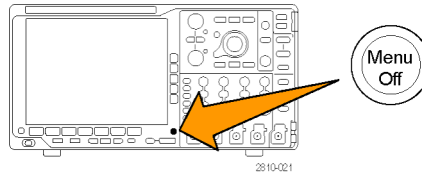

3. Release **Menu Off**, and then release **Autoset**.

4. Select the desired side-bezel setting.

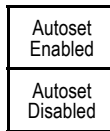

### Quick Tips

- To position the waveform appropriately, Autoset may change the vertical position. Autoset always sets vertical offset to 0 V.
- If you use Autoset when no channels are displayed, the instrument turns on channel 1 and scales it.
- If you use Autoset and the oscilloscope detects a video signal, the oscilloscope automatically sets the trigger type to video and makes other adjustments to display a stable video signal.

## Acquisition Concepts

Before a signal can be displayed, it must pass through the input channel where it is scaled and digitized. Each channel has a dedicated input amplifier and digitizer. Each channel produces a stream of digital data from which the instrument extracts waveform records.

### Sampling Process

Acquisition is the process of sampling an analog signal, converting it into digital data, and assembling it into a waveform record, which is then stored in acquisition memory.

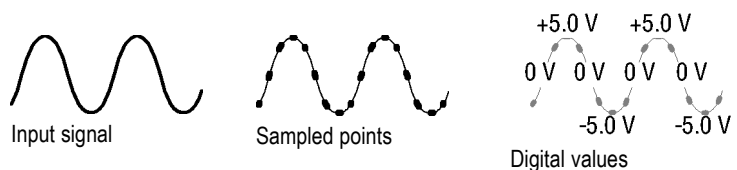

## Real-Time Sampling

MSO4000B and DPO4000B Series oscilloscopes use real-time sampling. In real-time sampling, the instrument digitizes all of the points it acquires using a single trigger event.

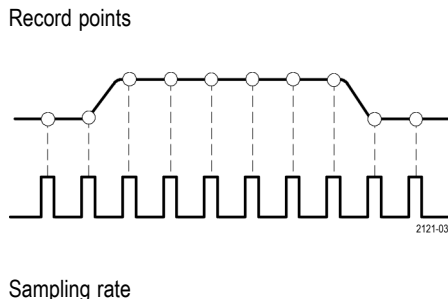

## Waveform Record

The instrument builds the waveform record through use of the following parameters:

- **Sample interval:** The time between recorded sample points. Adjust this by turning the **Horizontal Scale** knob or pushing **Acquire** and changing the record length in the Acquire menu.
- **Record length:** The number of samples required to fill a waveform record. Set this by pushing the **Acquire** button and using the resulting lower- and side-bezel menus.
- **Trigger point:** The zero time reference in a waveform record. It is shown on the screen by an orange T.
- **Horizontal position:** When **Delay Mode** is on, this is the time from the trigger point to the expansion point. Adjust this by turning the **Horizontal Position** knob. Use a positive time to acquire the record after the trigger point. Use a negative time to acquire it before the trigger point.
- **Expansion point:** The point that the horizontal scale expands and contracts around. It is shown by an orange triangle.

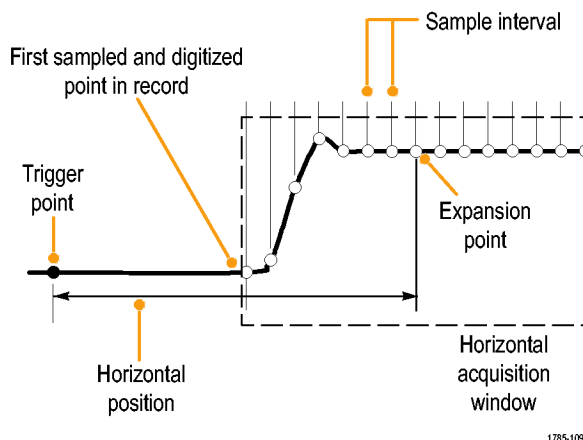

## How the Analog Acquisition Modes Work

**Sample** mode retains the first sampled point from each acquisition interval. Sample is the default mode.

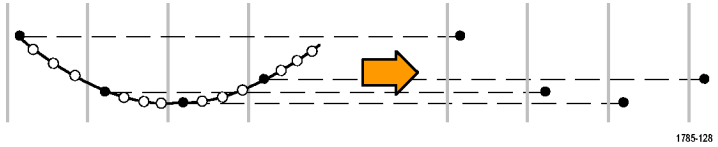

**Peak Detect** mode uses the highest and lowest of all the samples contained in two consecutive acquisition intervals. This mode only works with real-time, noninterpolated sampling and is useful for catching high frequency glitches.

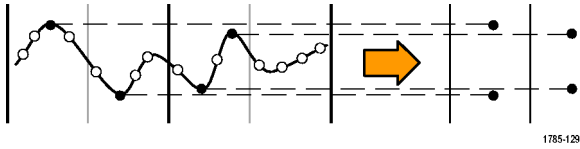

**Hi Res** mode calculates the average of all the samples for each acquisition interval. This mode also only works with real-time, noninterpolated sampling. Hi-Res provides a higher-resolution, lower-bandwidth waveform.

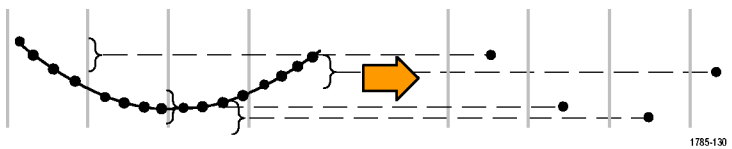

**Envelope** mode finds the highest and lowest record points over all acquisitions. Envelope uses Peak Detect for each individual acquisition.

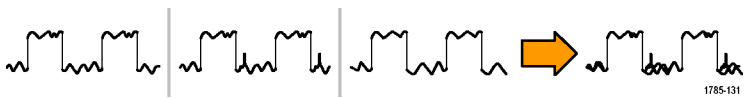

**Average** mode calculates the average value for each record point over a user-specified number of acquisitions. Average uses Sample mode for each individual acquisition. Use average mode to reduce random noise.



## Changing the Acquisition Mode, Record Length, and Delay Time

Use this procedure to change the acquisition mode.

1. Push **Acquire**.

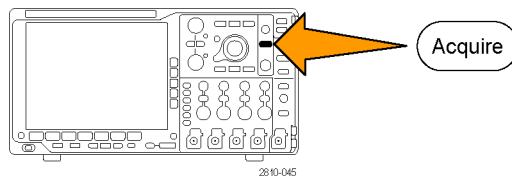

2. Push **Mode**.

Mode Sample	Record Length 10k	Delay On Off	Set Horiz. Position to 10%	Waveform Display	XY Display Off	
----------------	----------------------	-----------------	----------------------------------	---------------------	-------------------	--



3. Then choose the acquisition mode from the side-bezel menu. You can choose from: Sample, Peak Detect, Hi Res, Envelope, or Average.

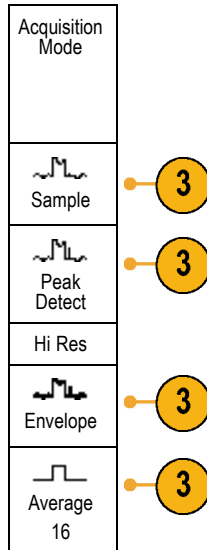

**NOTE.** Peak Detect and Hi Res modes take advantage of sample points that the oscilloscope would have discarded at lower sweep speeds. Therefore, these modes only work when the current sample rate is less than the maximum possible sample rate. As soon as the oscilloscope starts to acquire at the maximum sample rate, then the Peak Detect, Hi Res and Sample modes all look the same. You can control the sample rate by setting the Horizontal scale and the Record Length.

4. If you chose **Average**, turn multipurpose knob **a** to set the number of waveforms to average over.

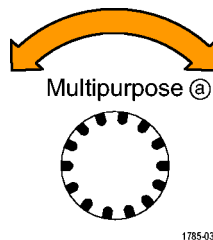

1785-038

5. Push **Record Length**.
6. Scroll through the available choices. Choose among 1000, 10 k, 100 k, 1 M, 5 M, 10 M, and 20 M points.

7. Push the lower-bezel **Delay** button to select **On** when you want to delay the acquisition relative to the trigger event.

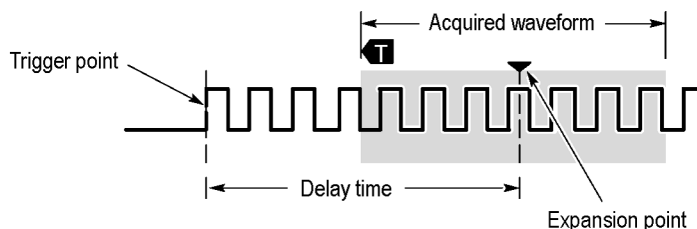

With **Delay** set to **On**, turn the **Horizontal Position** knob counterclockwise to increase the delay. The trigger point will move to the left and ultimately outside of the acquired waveform. Then you can adjust the **Horizontal Scale** knob to acquire more detail around the area of interest at the center of the screen.

When this delay is on, the trigger point separates from the horizontal expansion point. The horizontal expansion point stays at the center of the screen. The trigger point can move off the screen. When this happens, the trigger marker turns to point in the direction of the trigger point.

Use the delay feature when you want to acquire waveform detail that is separated from the trigger event by a significant interval of time. For example, you can trigger on a sync pulse that occurs once every 10 ms and then look at high-speed signal characteristics that occur 6 ms after the sync pulse.

When the delay feature is set to **Off**, the expansion point is tied to the trigger point so that scale changes are centered around the trigger point.

## Using Roll Mode

Roll mode gives a display similar to a strip chart recorder for low-frequency signals. Roll mode lets you see acquired data points without waiting for the acquisition of a complete waveform record.

Roll mode is enabled when the trigger mode is auto and the horizontal scale is set to 40 ms/div or slower.

### Quick Tips

- Switching to Envelope or Average acquisition mode, using digital channels, using math waveforms, turning on a bus, or switching to Normal trigger will disable Roll mode.
- Roll mode is disabled when you set the horizontal scale to 20 ms per division or faster.
- Push **Run/Stop** to halt Roll mode.

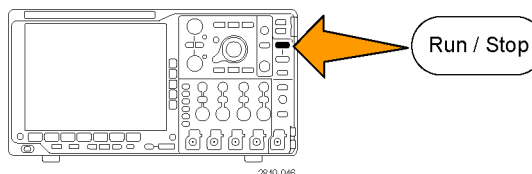

## Setting Up a Serial or Parallel Bus

Your oscilloscope can decode and trigger on signal events or conditions that occur on:

**Table 1: (Category) specifications**

Bus type	With this hardware
Audio (I <sup>2</sup> S, Left Justified (LJ), Right Justified (RJ), and TDM)	DPO4AUDIO application module
CAN and LIN	DPO4AUTO or DPO4AUTOMAX application module
Ethernet	DPO4ENET application module
FlexRay	DPO4AUTOMAX application module
I <sup>2</sup> C and SPI	DPO4EMBD application module
MIL-STD-1553	DPO4AERO application module
Parallel	MSO4000B Series oscilloscope
RS-232, RS-422, RS-485, and UART	DPO4COMP application module
USB 2.0	DPO4USB application module

(See page 15, *Application Module Free Trial*.)

### Using Buses in Two Steps

To quickly use serial bus triggering:

1. Push **B1**, **B2**, **B3**, or **B4** and enter parameters of the bus on which to trigger. You can separately assign a different bus to each of the **B1**, **B2**, **B3**, and **B4** buttons.

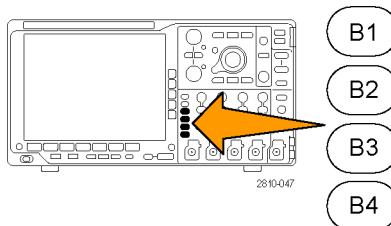



2. Push Trigger **Menu** and enter trigger parameters. (See page 73, *Choosing a Trigger Type*.)  
You can display bus information without triggering on the bus signal.

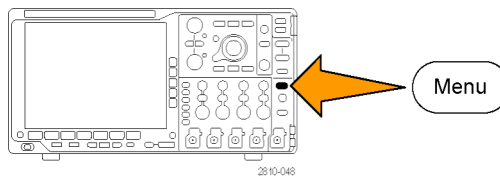

## Setting Up Bus Parameters

**NOTE.** For most serial bus sources, use any combination of channels 1 through 4, and D15 through D0. Some serial buses also use Ref 1 through 4 and Math as sources for protocol decode.

To trigger on serial or parallel bus conditions, refer to Triggering on Buses. (See page 76, *Triggering on Buses*.)

To set up bus parameters:

1. Push **B1**, **B2**, **B3**, or **B4** to bring up the lower-bezel bus menu.

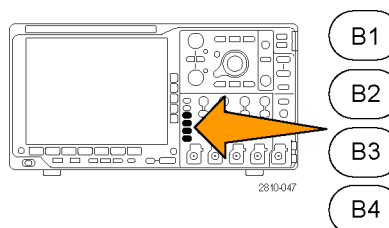

2. Push **Bus**. Turn multipurpose knob **a** to scroll through the list of bus types and select the desired bus: Parallel (MSO4000B Series only), I<sup>2</sup>C, SPI, RS-232, CAN, LIN, FlexRay, Audio, USB, Ethernet, or MIL-STD-1553.

Bus B1 Parallel	Define Inputs	Thresholds		B1 Label Parallel	Bus Display	Event Table
--------------------	---------------	------------	--	----------------------	-------------	-------------

The actual menu items shown will depend on your model oscilloscope and the application modules installed.



3. Push **Define Inputs**. The choices depend on the selected bus.

Use the side-bezel buttons to define parameters for the inputs, such as specific signals to an analog or digital channel.

If you select **Parallel**, push the side-bezel button to enable or disable **Clocked Data**.

Push the side-bezel button to select the **Clock Edge** on which to clock data: rising edge, falling edge, or both edges.

Turn multipurpose knob **a** to select the **Number of Data Bits** in the parallel bus.

Turn multipurpose knob **a** to select the desired bit to define.

Turn multipurpose knob **b** to select the desired analog or digital channel as the source for the bit.

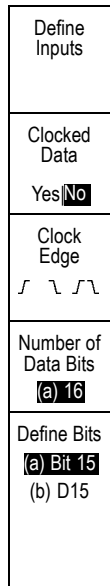

4. Push **Thresholds**.

Bus B1 Parallel	Define Inputs	Thresholds		B1 Label Parallel	Bus Display	Event Table
--------------------	---------------	------------	--	----------------------	-------------	-------------

You can set the threshold for all channels in the parallel or serial bus from a list of preset values. The preset values vary, depending on the bus type.

Alternately, you can set the threshold to a specific value for the signals that make up the parallel or serial bus. To do so, push the **Select** side-bezel button and turn multipurpose knob **a** to select a Bit or a Channel number (Signal name).

Then, turn multipurpose knob **b** to define the voltage level above which the oscilloscope treats the signal as a logic high and below which as a logic low.

**NOTE.** Some buses use two thresholds per channel.

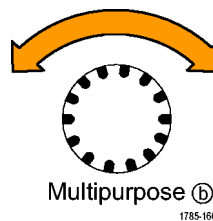
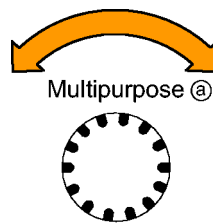

5. Optionally, push **B1 Label** to edit the label for the bus. (See page 45, *Labeling Channels and Buses*.)

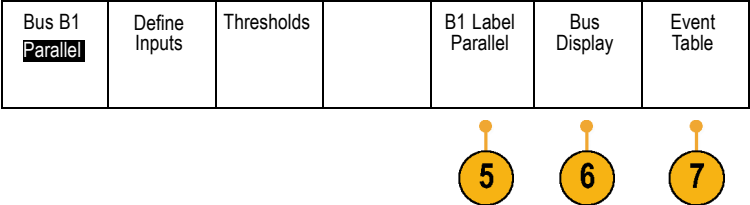

6. Push **Bus Display** and use the side-bezel menu to define how to display the parallel or serial bus.

Depending on the bus, use the side-bezel menu or the knobs to set the number format.

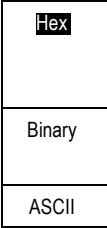

7. Push **Event Table** and select **On** to display a list of bus packets with timestamps.

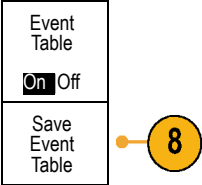

For a clocked parallel bus, the table lists the value of the bus at each clock edge. For an unlocked parallel bus, the table lists the value of the bus whenever any one of its bits changes.

The Event Table lists bytes, words, or packets, depending on the bus type.

8. Push **Save Event Table** to save the event table data in a .csv (spreadsheet) format on the currently selected storage device.

This example of an Event Table is from an RS-232 bus.

RS-232 event tables display one line for each 7- or 8-bit byte when Packets are set to Off.

RS-232 event tables display one line for each packet when Packets are set to On.

Other buses display one word, frame, or packet per row, depending on the bus type.

Tektronix		version v1.2f
Bus Definition: RS232		
Time	Tx	Rx
-4.77E-02	E	
-4.44E-02	n	
-4.10E-02	g	
-3.75E-02	i	
-3.41E-02	n	
-3.08E-02	e	
-2.73E-02	e	
-2.39E-02	r	
-2.06E-02	i	
-1.71E-02	n	
-1.37E-02	g	
-1.03E-02	,	
-6.92E-03	SP	
-3.49E-03	P	
-5.38E-05	o	
3.28E-03	r	
6.71E-03	t	
1.69E-02	l	
2.02E-02	a	
2.43E-02	n	
2.82E-02	d	
3.16E-02		

2319-085

- Push **B1**, **B2**, **B3**, or **B4** and turn multipurpose knob **a** to move the bus display up or down on the screen.

## I<sup>2</sup>C Bus

To acquire data from an I<sup>2</sup>C bus, you need to also set up these items:

- If you select **I<sup>2</sup>C**, push **Define Inputs** and the appropriate side-bezel menu choices.

Bus B1 <b>I<sup>2</sup>C</b>	Define Inputs	Thresholds	Include R/W in Address <b>No</b>	B1 Label I <sup>2</sup> C	Bus Display	Event Table
---------------------------------	---------------	------------	-------------------------------------	---------------------------	-------------	-------------

You can assign the predefined **SCLK Input** or **SDA Input** to the channel connected to the signal.



- Push **Include R/W in Address** and then push the desired side-bezel button.

This control determines how the oscilloscope shows the I<sup>2</sup>C addresses in bus decode traces, cursor readouts, Event Table listings, and trigger settings.

If you select **Yes**, the oscilloscope displays 7-bit addresses as eight bits, where the eighth bit (LSB) is the R/W bit. It displays 10-bit addresses as 11 bits where the third bit is the R/W bit.

If you select **No**, the oscilloscope displays 7-bit addresses as seven bits, and 10-bit addresses as ten bits.

In the physical layer of the I<sup>2</sup>C protocol, 10 bit I<sup>2</sup>C addresses are preceded by the five bit code, 11110. The oscilloscope does not include these five bits in address readouts.

## SPI Bus

To acquire data from an SPI bus, you need to also set up these items:

- If you selected **SPI**, push **Define Inputs** and the appropriate side-bezel menu choices.

Bus B1 <b>SPI</b>	Define Inputs	Thresholds	Configure	B1 Label SPI	Bus Display	Event Table
----------------------	---------------	------------	-----------	--------------	-------------	-------------



You can set the **Framing** to **SS** (Slave Select) or to **Idle Time**.

You can assign the predefined **SCLK**, **SS**, **MOSI**, or **MISO** signals to any channel.

- Push **Configure** and the desired side-bezel menu choices.

3. Push **SCLK** to set the edge of the signal to match the SPI bus being acquired.
4. Set the level of the SS, MOSI, and MISO signals to match the SPI bus.

Active High means that a signal is considered active when the signal is greater than the threshold value.

Active Low means that the signal is considered active when the signal is lower than the threshold value.

SCLK 	<b>3</b>
SS Active High Active Low	<b>4</b>
MOSI Active High Active Low	
MISO Active High Active Low	
-more- 1 of 2	

5. Use multipurpose knob **a** to set the number of bits of the SPI Word Size.
6. Push either side bezel button to set the bit order of the SPI bus.

Word Size (a) 8 bits	<b>5</b>
Bit Order MS First	<b>6</b>
Bit Order LS First	

## RS-232 Bus

To acquire data from a RS-232 bus, you need to also set up these items:

1. If you selected **RS-232**, push **Configure** and the desired side-bezel menu choices.

Use the side-bezel menu to configure the bus. Use Normal polarity for RS-232 signals and Inverted polarity for RS-422, RS-485, and UART buses.

Bus B1 RS-232	Define Inputs	Thresholds	Configure 9600-8-N	B1 Label RS-232	Bus Display	Event Table
------------------	---------------	------------	-----------------------	--------------------	-------------	-------------

**1**

- 2. Push **Bit Rate**, and turn multipurpose knob **a** to select the appropriate bit rate.
- 3. Push **Data Bits** and select the number to match the bus.
- 4. Push **Parity** and turn multipurpose knob **a** to match the polarity used by the bus as None, Odd, or Even.
- 5. Push **Packets** and select On or Off.
- 6. Turn multipurpose knob **a** to select an end-of-packet character.

Bit Rate 9600 bps	2
Data Bits 7 8	3
Parity (a) None	4
Packets On Off	5
End of Packet 0A (Linefeed)	6

RS-232 decoding displays a stream of bytes. You can organize the stream into packets with an end-of-packet character

If you defined an end-of-packet character to use for RS-232 decoding, the stream of bytes will be displayed as packets.

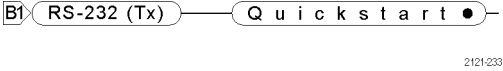

When decoding an RS-232 bus in ASCII mode, a large dot indicates that the value represents a character outside the printable ASCII range.

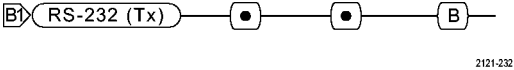

### CAN Bus

To acquire data from a CAN bus, you need to also set up these items:

- 1. If you selected **CAN**, push **Define Inputs** and the appropriate side-bezel menu choices.

Bus B1 CAN	Define Inputs	Thresholds	Bit Rate 500 Kbps	B1 Label CAN	Bus Display	Event Table
---------------	---------------	------------	----------------------	-----------------	-------------	-------------

1

2. Turn multipurpose knob **a** to select the channel connected to the CAN bus source.
3. Turn multipurpose knob **a** to select the type of CAN signal: CAN\_H, CAN\_L, Rx, Tx, or Differential.
4. Turn multipurpose knob **a** to set the **Sample Point** from 5% to 95% of the position within the bit period or the unit interval.

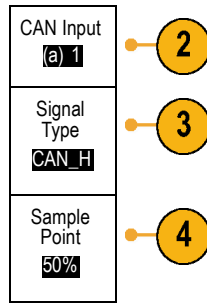

5. Push **Bit Rate** and turn multipurpose knob **a** to select from the list of predefined bit rates.

Alternately, you can set the bit rate to a specific value. To do so, select **Custom**, and then turn multipurpose knob **b** to set the bit rate from 10,000 to 1,000,000.

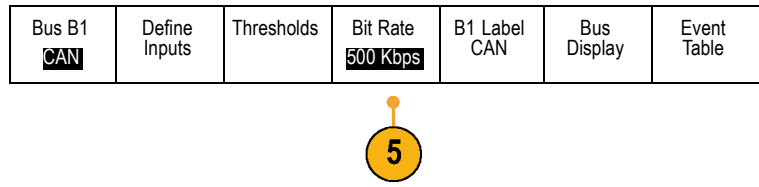

## LIN Bus

To acquire data from a LIN bus, you need to also set up these items:

1. If you selected **LIN**, push **Define Inputs** and the appropriate side-bezel menu choices.

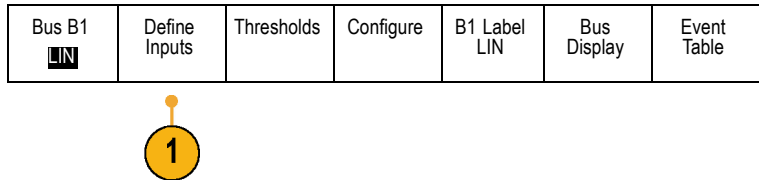

2. Turn multipurpose knob **a** to select the channel connected to the LIN bus source.
3. Turn multipurpose knob **a** to set the **Sample Point** from 5% to 95% of the position within the bit period or the unit interval.
4. Select the **Polarity** to match the LIN bus being acquired.

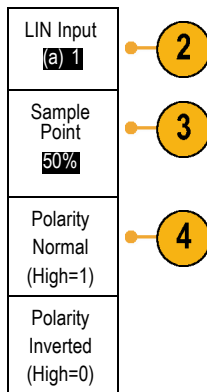



5. Push **Configure** and the appropriate side-bezel menu choices.

Bus B1 <b>LIN</b>	Define Inputs	Thresholds	Configure	B1 Label LIN	Bus Display	Event Table
----------------------	---------------	------------	-----------	-----------------	-------------	-------------



6. Push **Bit Rate**, and turn multipurpose knob **a** to select from the list of predefined bit rates. Alternately, you can set the bit rate to a specific value. To do so, select **Custom**, and then turn multipurpose knob **b** to set the bit rate from 800 bps to 100,000 bps.
7. Push **LIN Standard**, and turn multipurpose knob **a** to select the appropriate standard.
8. Push **Include Parity Bits with Id** to select whether or not to include parity bits.

Bit Rate (a) <b>19.2K bps</b>
LIN Standard <b>V1.x</b>
Include Parity Bits with Id On  <b>Off</b>



## Audio Bus

To acquire data from an Audio bus, you need to also set up these items:

1. If you selected **Audio**, push **Define Inputs** and the desired side-bezel menu choices.

Bus B1 <b>Audio</b>	Define Inputs	Thresholds	Configure	B1 Label RS-232	Bus Display	Event Table
------------------------	---------------	------------	-----------	--------------------	-------------	-------------



2. Push **Type**, and turn multipurpose knob **a** to select the type of audio bus data configuration on which to trigger.
3. Select **I2S** to trigger on the standard Inter-IC Sound, or Integrated Interchip Sound, electrical serial bus interface standard stereo format.
4. Select **Left Justified** to trigger on an I2S stream where there is no bit clock delay and the data starts right on the edge of the word select clock.
5. Select **Right Justified** to trigger on an I2S stream where the data lines up with the right edge of the word select clock.
6. Select **TDM** to trigger on time-division multiplexing.
  
7. Push **Configure**, and the appropriate side-menu buttons to further set up I2S triggering.

Audio Bus Type
I2S
Left Justified (LJ)
Right Justified (RJ)
TDM

## USB Bus

To acquire data from a USB bus, you need to also set up these items:

1. If you selected **USB**, push **Define Inputs** to set the USB bus speed and probe type.

Bus B1 <b>USB</b>	Define Inputs <b>Full Speed</b>	Thresholds		B1 Label <b>USB</b>	Bus Display	Event Table
----------------------	------------------------------------	------------	--	------------------------	-------------	-------------



- The Thresholds, Label, Bus Display, and Event Table menus operate similarly to the other serial buses.

## Ethernet

To acquire data from an Ethernet bus, you need to also set up these items:

- If you selected **Ethernet**, push **Define Inputs** and the desired side-bezel menu choices.

Bus (B1) <b>Ethernet</b>	Define Inputs <b>100BASE-TX</b>	Thresholds	IPv4 <b>Yes</b> No	(B1) Label <b>Ethernet</b>	Bus Display	Event Table
	1		3			

- The Thresholds, Bus Display, and Event Table menus operate similarly to the other serial buses.
- Push **IPv4** to decide whether or not to decode and trigger on Internet Protocol version 4 signals.

## MIL-STD 1553

To acquire data from a MIL-STD 1553 bus, you need to also set up these items:

Bus B1 <b>MIL - 1553</b>	Define Inputs	Thresholds <b>800 mV</b> <b>0.00 V</b>	RT <b>12.0µS</b> <b>4.00µS</b>	B1 Label <b>1553</b>	Bus Display	Event Table
	1	2	3	2	2	2

- Push **Define Inputs** and use multipurpose knob **a** to select the desired side-bezel menu choices. Select the polarity desired to match the MIL-STD-1553 bus being acquired.

2. The **Thresholds**, **Label**, **Bus Display**, and **Event Table** menu items operate similarly to how they work on other serial bus menus.
3. Push **RT** if you wish to change the Response Time (RT) maximum and minimum default values.

### Physical Layer Bus Activity

Oscilloscope waveform traces from analog channels 1 to 4, digital channels D15 to D0, Math waveforms, and the traces you see when you choose to display a bus always show the physical layer bus activity. In the physical layer display, bits that were transmitted earlier are to the left, and bits that were transmitted later are to the right.

- I2C, and CAN buses transmit the MSB (most significant bit) first
- SPI buses do not specify a bit order
- RS-232 and LIN buses transmit the LSB (least significant bit) first

---

**NOTE.** *The oscilloscope displays the decode traces and event tables for all buses with the MSB on the left and LSB on the right.*

---

For example, an RS-232 signal (after the start bit) might be high, high, high, low, high, low, low, and high. Since the RS-232 protocol uses high for zero and low for one, this value would be 0001 0110.

Since the decode displays the MSB first, the oscilloscope reverses the order of the bits and displays 0110 1000. If the bus display is set to hex, the value displays as 68. If the bus display is set to ASCII, the value displays as h.

## Setting Up Digital Channels

Use front-panel buttons and knobs to set up your instrument to acquire signals using the digital channels.

1. Connect the P6616 16-channel logic probe to the input signal source.

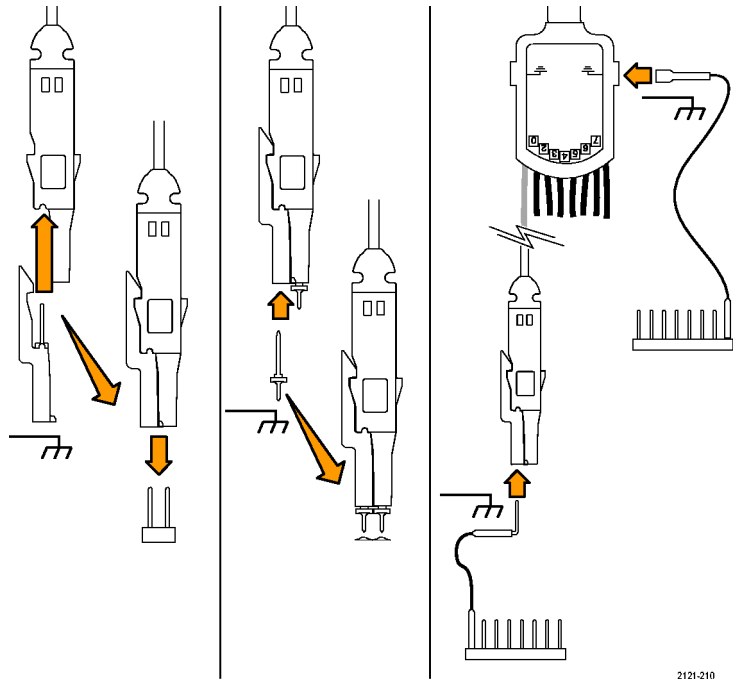

2. Connect the ground lead or leads to the circuit ground.  
You can connect a separate lead for each channel or a common ground lead for each group of 8 wires.
3. If needed, connect the appropriate grabber for each probe to the probe tip.
4. Connect the each probe to the desired circuit test point.
5. Push the **D15 - D0** front panel button to display the menu.

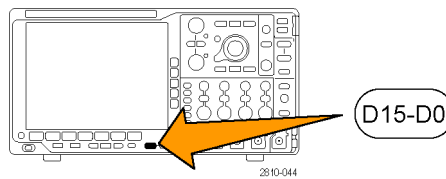

6. Push the lower-bezel **D15 - D0** button to access the D15 - D0 On or Off menu.

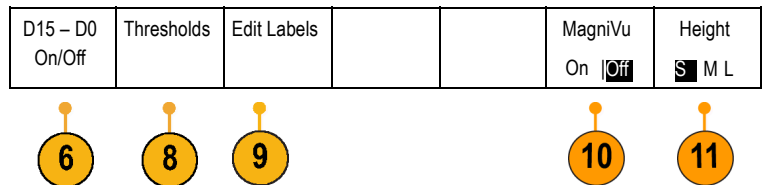

7. Turn multipurpose knob **a** to scroll through the list of digital channels. Turn multipurpose knob **b** to position the selected channel.  

As you position channels close to each other on the display, the oscilloscope groups the channels, and adds the group to the pop-up list. You can select the group from the list to move all the channels in the group instead of individual channels.
8. Push the lower-bezel **Thresholds** button. You can assign a different threshold value to each channel.
9. Push the lower-bezel **Edit Labels** button and create the label. You can create labels through the front panel or with an optional USB keyboard. (See page 45, *Labeling Channels and Buses*.)
10. Push the lower-bezel **MagniVu** button to increase the timing resolution. (See page 69, *When and Why to Turn On MagniVu*.)
11. Push the lower-bezel **Height** button repeatedly to set the signal height. You only need to do this once to set the height for all of the digital channels.

### Quick Tip

- Use the zoom feature to see multiple cycles of the signal in the upper part, and a single cycle in the lower part of the display. (See page 122, *Using Wave Inspector to Manage Long Record Length Waveforms*.)
- When setting up the logic probe, the first set of eight leads (pins 7 to 0) on the logic probe are marked GROUP 1 on the lead box. The second set (pins 15 to 8) is marked GROUP 2.
- The lead for the first channel in each group is colored blue for easy identification while you connect the logic probe to the device under test. The other leads are gray.
- Digital channels store a high or low state for each sample. The threshold that separates high from low can be set separately for each channel.

## When and Why to Turn On MagniVu

For MSO4000B Series only, MagniVu allows you to have higher resolution to accurately determine edge placement. This helps you to make precise timing measurements on digital edges. You can see up to 32 times more detail than with normal digital channel sampling.

The MagniVu record is acquired in parallel to the main digital acquisition and is available at any time, running or stopped. MagniVu provides an ultra high resolution view of your data sampled at a maximum resolution of 60.6 ps for 10,000 points centered around the trigger.

---

**NOTE.** MagniVu centers itself around the trigger point. If you turn MagniVu on while using a large record length and you are looking somewhere other than the trigger point, then the digital signal may be off screen. In most of these cases, you can find the digital record by looking for the digital signal in the upper overview and panning accordingly.

---



---

**NOTE.** You should turn on MagniVu when light gray shading is displayed to indicate the uncertainty of the edge position. If the shading is not displayed, you do not need to use MagniVu. (See page 96, Viewing Digital Channels.)

---

## Using MagniVu

1. Push **D15 – D0**.

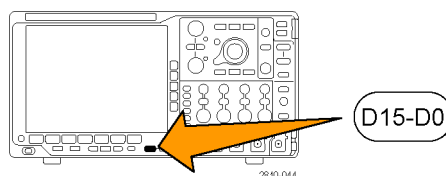

2. Push **MagniVu** and select **On**.

D15 – D0 On/Off	Thresholds	Label			MagniVu On <input type="radio"/> Off <input type="radio"/>	Height S M L
--------------------	------------	-------	--	--	---	-----------------

### Quick Tips

- If you think you need more timing resolution, turn on MagniVu to increase the resolution.
- MagniVu is always acquired. If the oscilloscope is in a stopped state, you can turn on MagniVu and still get the resolution without taking another acquisition.
- The serial bus features do not use data acquired in MagniVu mode.

# Trigger Setup

This section contains concepts and procedures for setting up the oscilloscope to trigger on your signal.

## Triggering Concepts

### Trigger Event

The trigger event establishes the time-reference point in the waveform record. All waveform record data is located in time with respect to that point. The instrument continuously acquires and retains enough sample points to fill the pretrigger portion of the waveform record. That is the part of the waveform that is displayed before, or to the left of, the triggering event on screen. When a trigger event occurs, the instrument starts acquiring samples to build the posttrigger portion of the waveform record, that is, the part displayed after or to the right of the trigger event. After a trigger is recognized, the instrument will not accept another trigger until the acquisition is complete and the holdoff time has expired.

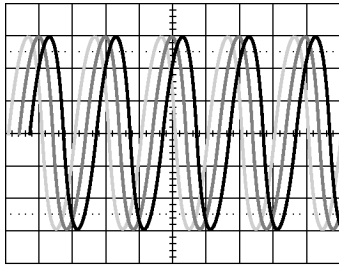

1785-087a

Untriggered display

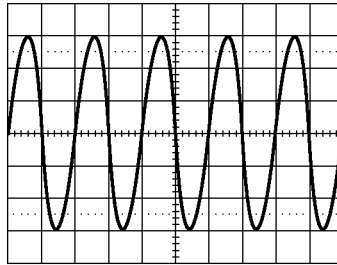

1785-087b

Triggered display

### Trigger Modes

The trigger mode determines how the instrument behaves in the absence of a trigger event:

- Normal trigger mode enables the instrument to acquire a waveform only when it is triggered. If no trigger occurs, the last waveform record acquired remains on the display. If no last waveform exists, no waveform is displayed.
- Auto trigger mode enables the instrument to acquire a waveform even if a trigger does not occur. Auto mode uses a timer that starts when the acquisition is started, and the pretrigger information is obtained. If a trigger event is not detected before the timer times out, the instrument forces a trigger. The length of time it waits for a trigger event depends on the time base setting.

Auto mode, when forcing triggers in the absence of valid triggering events, does not synchronize the waveform on the display. The waveform will appear to roll across the screen. If valid triggers occur, the display will become stable.

You can also force the instrument to trigger by pushing the front-panel **Force Trig** button.



## Trigger Holdoff

Adjust holdoff to obtain stable triggering when the instrument is triggering on undesired trigger events.

Trigger holdoff can help stabilize triggering, since the oscilloscope does not recognize new triggers during the holdoff time. When the instrument recognizes a trigger event, it disables the trigger system until acquisition is complete. In addition, the trigger system remains disabled during the holdoff period that follows each acquisition.

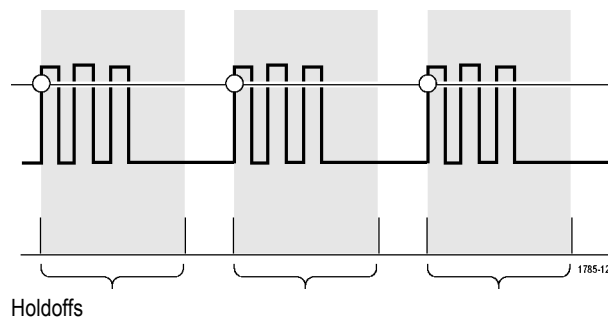

## Trigger Coupling

Trigger coupling determines what part of the signal is passed to the trigger circuit. Edge and Sequence triggering can use all available coupling types: DC, AC, Low Frequency Rejection, High Frequency Rejection, and Noise Rejection. All other trigger types use DC coupling only.

## Horizontal Position

When **Delay Mode** is on, use horizontal position to acquire waveform detail in a region that is separated from the trigger location by a significant interval of time.

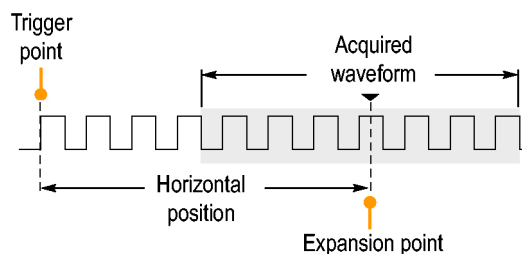

1. Adjust the position (delay) time by rotating the **Horizontal Position** knob.
2. Turn horizontal **SCALE** to acquire the detail that you need around the position (delay) expansion point.

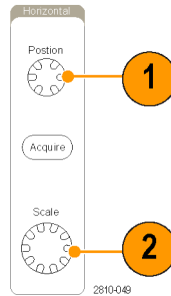

The part of the record that occurs before the trigger is the pretrigger portion. The part that occurs after the trigger is the posttrigger portion. Pretrigger data can help you troubleshoot. For example, to find the cause of an unwanted glitch in your test circuit, you can trigger on the glitch and make the pretrigger period large enough to capture data before the glitch. By analyzing what happens before the glitch, you may uncover information that helps you find the source of the glitch. Alternatively, to see what is happening in your system as a result of the trigger event, make the posttrigger period large enough to capture data after the trigger.

### Slope and Level

The slope control determines whether the instrument finds the trigger point on the rising or the falling edge of a signal.

The level control determines where on that edge the trigger point occurs.

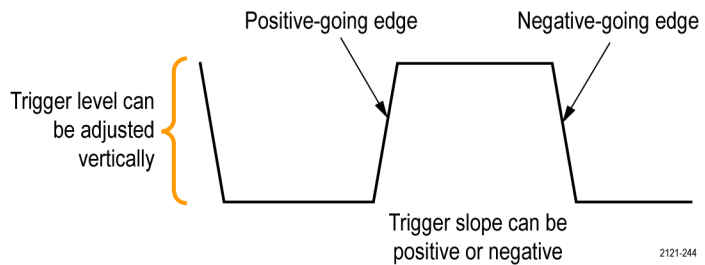

The oscilloscope provides a long horizontal bar or bars across the graticule to temporarily show the trigger level.

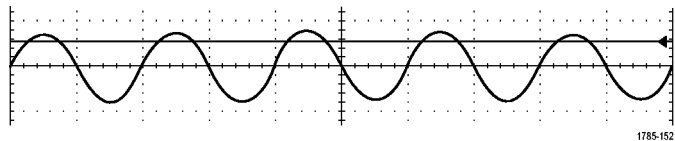

1. Turn the front-panel Trigger **Level** knob to adjust the trigger level without going to a menu.
2. Push the front-panel Trigger **Level** knob to quickly set the trigger level to the midpoint of the waveform.

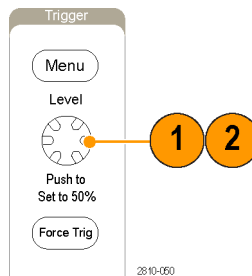

## Choosing a Trigger Type

To select a trigger:

1. Push Trigger **Menu**.

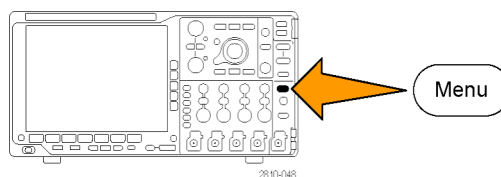

2. Push **Type** to bring up the **Trigger Type** side-bezel menu.

**NOTE.** The bus trigger in the MSO4000B Series works on parallel buses even without an application module. Using the bus trigger on other buses requires use of the DPO4AERO, DPO4AUDIO, DPO4AUTO, DPO4AUTOMAX, DPO4COMP, DPO4EMBD, DPO4ENET, or DPO4USB application module.

Trigger Type
Sequence (B Trigger)
Pulse Width
Timeout
Runt
Logic
Setup & Hold
Rise/Fall Time
Video
Bus

3. Turn multipurpose knob **a** to select the desired trigger type.

4. Complete the trigger setup using the lower-bezel menu controls displayed for the trigger type. The controls to set up the trigger vary depending on the trigger type.

Type <b>Edge</b>	Source <b>1</b>	Coupling <b>DC</b>	Slope 	Level <b>100 mV</b>		Mode <b>Auto</b> & Holdoff
<b>2</b>	<b>4</b>	<b>4</b>	<b>4</b>	<b>4</b>		

## Selecting Triggers

### Trigger Type

Edge

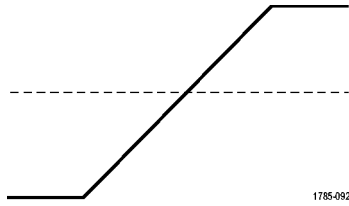

### Trigger Conditions

Trigger on a rising or falling edge, as defined by the slope control. Coupling choices are DC, LF Reject, HF Reject, and Noise Reject.

Edge triggers are the simplest and most commonly used trigger type, with both analog and digital signals. An edge trigger event occurs when the trigger source passes through a specified voltage level in the specified direction.

Sequence  
(B Trigger)

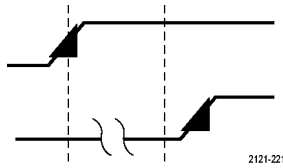

Combine an edge A Event (Main) trigger with the B Event (Delayed) trigger to capture more complex signals. (See page 81, *Using Sequence Trigger (A (Main) and B (Delayed))*.)

**Time.** After the A Event occurs, the trigger system waits the specified amount of time, and then looks for the B Event before triggering and displaying the waveform.

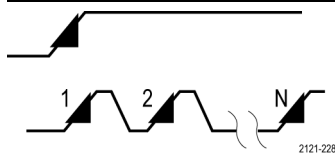

**Events.** After the A Event occurs, the trigger system looks for a specified number of B Events before triggering and displaying the waveform.

Pulse Width

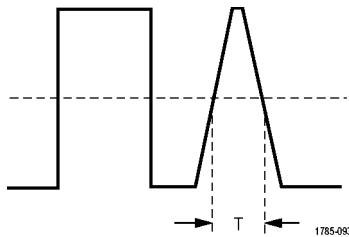

Trigger on pulses that are less than, greater than, equal to, not equal to, a specified time. Additionally, you can trigger when a pulse width is within or outside a range of two different specified times. You can also trigger on positive or negative pulses. Pulse width triggers are primarily used on digital signals.

Timeout

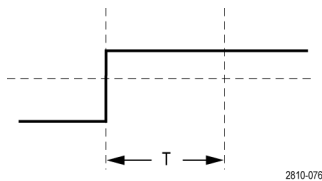

Trigger when no pulse is detected within a specified time.

Runt

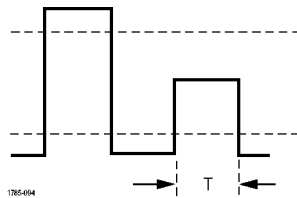

Trigger on a pulse amplitude that crosses one threshold but fails to cross a second threshold before recrossing the first. You can detect positive or negative (or either) runts, or only those wider than, less than, greater than, equal to, or not equal to a specified width. Runt triggers are primarily used on digital signals.

## Trigger Type

Logic

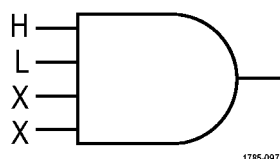

## Trigger Conditions

Trigger when all channels transition to the specified state. Use multipurpose knob **a** to select a channel. Push the appropriate side-bezel button to set that channel's state to **High (H)**, **Low (L)**, or **Don't Care (X)**.

Use the **Clock** side-bezel button to enable clocked (state) triggering. You can have at most a single clock channel. Push the **Clock Edge** lower-bezel button to change the polarity of the clock edge. Turn off clocked triggering and return to unclocked (pattern) triggering by selecting the clock channel and setting it to high, low, or don't care.

For unclocked triggering, by default, triggering occurs when the selected condition goes true. You can also select triggering when the condition goes false, or time-qualified triggering.

You can use up to 20 channels for a logic trigger (4 analog and 16 digital) with MSO4000B Series oscilloscopes.

**NOTE.** Optimum Logic trigger performance is achieved by using only analog channels or only digital channels.

Setup and Hold

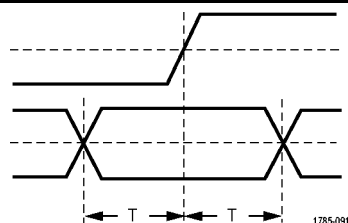

Trigger when a logic data input changes state inside of the setup or hold time relative to a clock edge.

Setup is the amount of time that data should be stable and not change before a clock edge occurs. Hold is the time that data should be stable and not change after a clock edge occurs.

MSO4000B Series oscilloscopes are capable of multiple channel Setup and Hold triggering, and can monitor the state of an entire bus for setup and hold violations. You can use up to 20 channels for a Setup and Hold trigger (4 analog and 16 digital) with MSO4000B Series oscilloscopes.

Use the **Clock** side-bezel button to select the clock channel. Use the **Select** control, **Data**, and **Not used** buttons to select one or more channels you want to monitor for setup and hold violations.

**NOTE.** Optimum Setup and Hold trigger performance is achieved by using only analog channels or only digital channels.

Rise/Fall Time

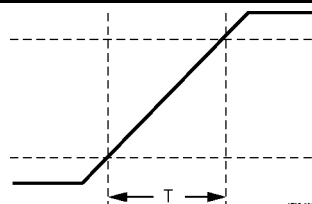

Trigger on rise and fall times. Trigger on pulse edges that traverse between two thresholds at faster or slower rates than the specified time. Specify pulse edges as positive or negative or either.

**Trigger Type**

Video

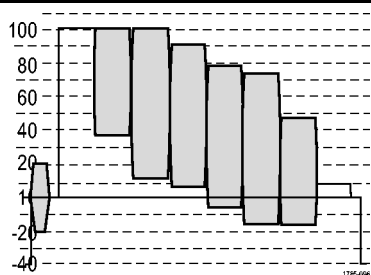

**Trigger Conditions**

Trigger on specified fields or lines of a composite video signal. Only composite signal formats are supported. Trigger on NTSC, PAL, or SECAM. Works with Macrovision signals. With the DPO4VID module, trigger on a variety of HDTV video standard signals, as well as custom (non-standard) bilevel and trilevel video signals with 3 to 4,000 lines.

Bus

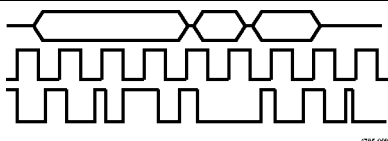

Trigger on various bus conditions. I<sup>2</sup>C requires a DPO4EMBD module. SPI requires a DPO4EMBD module. CAN requires a DPO4AUTO or DPO4AUTOMAX module. RS-232, RS-422, RS-485, and UART require a DPO4COMP module. LIN requires either a DPO4AUTO or a DPO4AUTOMAX module. FlexRay requires a DPO4AUTOMAX module. Audio requires a DPO4AUDIO module. USB requires a DPO4USB module. Ethernet requires a DPO4ENET module. MIL-STD-1553 requires a DPO4AERO module. Parallel requires an MSO4000B Series oscilloscope. (See page 15, *Application Module Free Trial*.)

**Triggering on Buses**

You can use your oscilloscope to trigger on multiple data buses, if you have the appropriate application module installed. The MSO4000B Series can trigger on parallel buses without an application module. The oscilloscope can display both physical layer (as analog waveforms) and protocol level information (as digital and symbolic waveforms).

To set up the bus trigger:

1. If you have not already defined your bus using the front-panel **B1**, **B2**, **B3**, or **B4** buttons, do so now. (See page 54, *Setting Up a Serial or Parallel Bus*.)

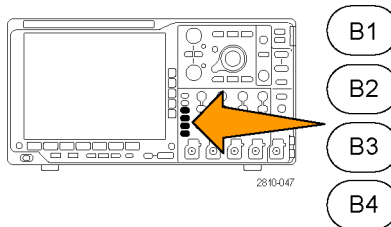

2. Push Trigger **Menu**.

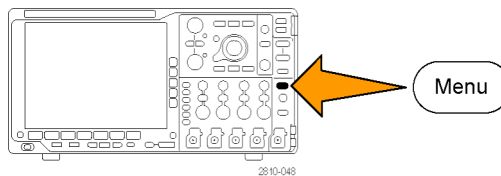

3. Push **Type**.

Type <b>Bus</b>	Source Bus <b>B1 (I2C)</b>	Trigger On <b>Address</b>	Address <b>07F</b>		Direction <b>Write</b>	Mode <b>Auto &amp; Holdoff</b>
--------------------	-------------------------------	------------------------------	-----------------------	--	---------------------------	-----------------------------------

4. Turn multipurpose knob **a** to scroll through the trigger type side menu until you select **Bus**.
5. Push **Source Bus** and use the Source Bus side menu to select the bus that you want to trigger on.
6. Push **Trigger On** and select the desired trigger on feature from the side-bezel menu.



## Parallel Bus Trigger

You can trigger on a binary or hex data value. Push the lower-bezel **Data** button and enter the parameters of interest with multipurpose knobs **a** and **b**.

## I<sup>2</sup>C Bus Trigger

You can trigger on **Start**, **Repeated Start**, **Stop**, **Missing Ack**, **Address**, **Data**, or **Address/Data**.

If you are setting up an I<sup>2</sup>C trigger and have made a **Trigger On** selection of **Address** or **Address/Data**, push the lower-bezel **Address** button to access the I<sup>2</sup>C Address side-bezel menu.

Push the side-bezel **Addressing Mode** button and select **7 bit** or **10 bit**. Push the side-bezel **Address** button. Enter the address parameters of interest with multipurpose knobs **a** and **b**.

Then push the lower-bezel menu **Direction** button and select the direction of interest: **Read**, **Write**, or **Read or Write**.

If you have made a **Trigger On** selection of **Data** or **Address/Data**, push the lower-bezel **Data** button to access the I<sup>2</sup>C Data side-bezel menu.

Push the **Number of Bytes** button and enter the number of bytes with multipurpose knob **a**.

Push the side-bezel **Addressing Mode** button and select **7-bit** or **10-bit**. Push the side-bezel **Data** button. Enter the data parameters of interest with multipurpose knobs **a** and **b**.

For more information on the I<sup>2</sup>C address formats, refer to item 2 under *Setting Up Bus Parameters*.

## SPI Bus Trigger

You can trigger on **SS Active**, **MOSI**, **MISO**, or **MOSI & MISO**.

If you are setting up an SPI trigger and have made a **Trigger On** selection of **MOSI** or **MISO**, push the lower-bezel **Data** button, push the side-bezel **MOSI** or **MISO** button, and enter the data parameters of interest with multipurpose knobs **a** and **b**.

Then push the **Number of Bytes** button and enter the number of bytes with multipurpose knob **a**.

If you select **MOSI & MISO**, push the lower-bezel **Data** button and enter the parameters of interest in the side-bezel menus.

## RS-232 Bus Trigger

You can trigger on **Tx Start Bit**, **Rx Start Bit**, **Tx End of Packet**, **Rx End of Packet**, **Tx Data**, or **Rx Data**.

If you are setting up an RS-232 trigger and have made a **Trigger On** selection of **Tx Data** or **Rx Data**, push the lower-bezel **Data** button.

Push the **Number of Bytes** button and enter the number of bytes with multipurpose knob **a**.

Push the side-bezel **Data** button, and enter the parameters of interest with multipurpose knobs **a** and **b**.

## CAN Bus Trigger

You can trigger on **Start of Frame**, **Type of Frame**, **Identifier**, **Data**, **Id & Data**, **End of Frame**, and **Missing Ack**.

If you are setting up a CAN trigger and have made a **Trigger On** selection of **Type of Frame**, push the lower-bezel **Frame Type** button, and select **Data Frame**, **Remote Frame**, **Error Frame**, or **Overload Frame**.

If you have made a **Trigger On** selection of **Identifier**, push the lower-bezel **Identifier** button and select a **Format**. They push the **Identifier** side-bezel button, and enter a binary or hex value with multipurpose knobs **a** and **b**.

Push the lower-bezel menu **Direction** button and select the direction of interest: **Read**, **Write**, or **Read or Write**.

If you have made a **Trigger On** selection of **Data**, push the lower-bezel **Data** button and enter the parameters of interest.

## LIN Bus Trigger

You can trigger on **Sync**, **Identifier**, **Data**, **Id & Data**, **Wakeup Frame**, **Sleep Frame**, or **Error**.

If you are setting up an LIN trigger and have made a **Trigger On** selection of **Identifier**, **Data**, or **Identifier & Data**, push the lower-bezel **Identifier** or **Data** buttons and enter the parameters of interest on the resulting side-bezel menu.

If you have made a **Trigger On** selection of **Error**, push the lower-bezel **Error Type** button and enter the parameters of interest on the resulting side-bezel menu.

## FlexRay Bus Trigger

You can trigger on **Start of Frame**, **Type of Frame**, **Identifier**, **Cycle Count**, **Header Fields**, **Data**, **Id & Data**, **End of Frame** or **Error**.

## Audio Bus Trigger

If you are using an **I2C**, Left Justified (**LJ**), or Right Justified (**RJ**) audio bus, you can trigger on **Word Select** or **Data**.

If you are using an **TDM** audio bus, you can trigger on **Frame Sync** or **Data**.



## USB Bus Trigger

You can trigger on **Sync**, **Reset**, **Suspend**, **Resume**, **End of Packet**, **Token (Address) Packet**, **Data Packet**, **Handshake Packet**, **Special Packet**, or **Error**.

## Ethernet Bus Trigger

You can trigger on **Start Frame Delimiter**, **MAC Addresses**, **MAC Length/Type**, **TCP/IPv4 Client Data**, **End of Packet**, **Idle**, or an **FCS (CRC) Error**. If you turn on **Q-(VLAN) Tagging**, you can also trigger on **MAC Q-Tag Control Information**.

## MIL-STD-1553 Bus Trigger

You can trigger on **Sync**, **Command**, **Status**, **Data**, **Time (RT/IMG)**, or **Error**.

If you are setting up a MIL-STD-1553 trigger and have made a **Trigger On** selection of **Command**, push the lower-bezel **RT Address** button to enter specific values of **RT Address** to trigger on. Push the lower-bezel **Command Word Details** button to enter the **T/R bit** value, **Subaddress/Mode** value, **Word Count/Mode Code** value, and **Parity** value.

If you are setting up a MIL-STD-1553 trigger and have made a **Trigger On** selection of **Status**, push the lower-bezel **RT-Address** button to enter specific values of **RT Address** to trigger on. Push the lower-bezel **Status Word Bits** button to enter values for **Message Error (bit 9)**, **Instr. (bit 10)**, **Service Req. (bit 11)**, **BCR (bit 15)**, **Busy (bit 16)**, **Subsystem Flag (bit 17)**, **DBCA (bit 18)**, **Terminal Flag (bit 19)** and **Parity**.

If you are setting up a MIL-STD-1553 trigger and have made a **Trigger On** selection of **Data**, push the lower-bezel **Data** button to enter specific **Data** values, and the **Parity** value.

If you are setting up a MIL-STD-1553 trigger and have made a **Trigger On** selection of **Time (RT/IMG)**, push the lower-bezel **Trigger When** button to set the trigger condition. Push the lower-bezel **Times** button to set the **Maximum** and **Minimum** times.

If you are setting up a MIL-STD-1553 trigger and have made a **Trigger On** selection of **Error**, push the lower-bezel **Error Type** button to select the type of error to trigger on.

## I<sup>2</sup>C, SPI, USB, Ethernet, CAN, LIN, and FlexRay Bus Trigger Data Matching

**Rolling window byte matching for I<sup>2</sup>C, SPI, USB, and FlexRay.** To use a rolling window to trigger on data, you define the number of bytes to match. Then the oscilloscope uses a rolling window to find any match within a packet, with the window rolling one byte at a time.

For example, if the number of bytes is one, the oscilloscope will attempt to match the first byte, second byte, third, and so on within the packet.

If the number of bytes is two, the oscilloscope will try to match any two consecutive bytes, such as one and two, two and three, three and four, and so on. If the oscilloscope finds a match, it will trigger.

With FlexRay, USB, or Ethernet, obtain a rolling window match by setting the **Byte Offset** in the Data menu to **Don't care**.

## Specific byte matching (non-rolling window matching for a specific position in the packet) for I<sup>2</sup>C, SPI, USB, CAN, and FlexRay.

You can trigger on a specific byte for I<sup>2</sup>C, SPI, CAN, and FlexRay in several ways:

- For I<sup>2</sup>C and SPI, enter the number of bytes to match the number of bytes in the signal. Then use don't cares (X) to mask the bytes that you are not interested in.
- For I<sup>2</sup>C, push the lower-bezel **Trigger On** to trigger on **Address/Data**. Push **Address**. On the side-bezel menu, push **Address**, and rotate multipurpose knobs **a** and **b** as needed. Set the address to don't cares (X) if you want to mask the address. The data will be matched starting at the first byte without using a rolling window.
- For USB, triggering occurs when the user-selected data input matches the data and qualifier in the signal starting at the byte offset. Set the number of bytes to match the number of bytes of interest. Use the data qualifier to perform: =, !=, <, >, >=, and <= operations.
- For CAN, triggering occurs when the user-selected data input matches the data and qualifier in the signal starting at the first byte. Set the number of bytes to match the number of bytes of interest. Use the data qualifier to perform: =, !=, <, >, >=, and <= operations. Triggering on identifier and data always matches the identifier and data selected by the user, with the data starting at the first byte. No rolling window is used.
- For FlexRay and Ethernet, triggering occurs when the user-selected data input matches the data and qualifier in the signal starting at the byte offset. Set the number of bytes to match the number of bytes of interest. Use the data qualifier to perform: =, !=, <, >, >=, and <= operations. Triggering on identifier and data always matches the identifier and data selected by the user, with the data starting at the first byte. No rolling window is used.

## Data Value Matching

You can trigger on a specific data value for RS-232 bytes. If you defined an end-of-packet character to use for RS-232 bus decoding, you can use the same end-of-packet character as a data value for trigger data matching. To do so, choose the Tx End of Packet or the Rx End of Packet character as the Trigger On selection.

You can also trigger on a specific data value for other buses.

## Parallel Bus Trigger Data Matching

Optimum parallel bus trigger performance is achieved by using only analog channels or only digital channels (MSO4000B Series only).

## Checking Trigger Settings

To quickly determine the settings of some key trigger parameters, check the Trigger readout at the bottom of the display. The readouts differ for edge and the advanced triggers.

1. Trigger source = channel 1.
2. Trigger slope = rising.
3. Trigger level = 0.00 V.

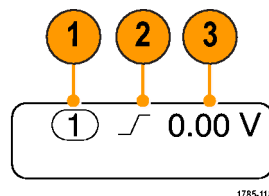

Edge trigger readout

## Using Sequence Trigger (A (Main) and B (Delayed))

Combine an edge A Event (Main) trigger with the B Event (Delayed) trigger to capture more complex signals. After the A Event occurs, the trigger system looks for the B Event before triggering and displaying the waveform.

A and B triggers can (and typically do) have separate sources.

Use the Edge trigger menu to set up the A trigger first. Then, to use the B trigger:

1. Push Trigger **Menu**.

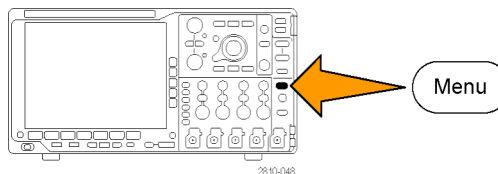

2. Push **Type**.
3. Turn multipurpose knob **a** to select a trigger type of **Sequence (B Trigger)**.  
This brings up the Sequence (B Trigger) menu.

4. Push **B Trigger After A**.

Type	Source	Coupling	Slope	Level	B Trigger After A	Mode
Sequence (B Trigger)	1	DC		0.00 V	Time	Auto & Holdoff



Push a side-bezel button to select sequencing the B trigger after the A as Time or as Events.

Time (a) 8 ns
B Events 1
Set to Minimum

- Set the other Sequence Trigger parameters in the related side- and lower-bezel menus.

### B Trigger After Delay Time

The A trigger arms the instrument. Posttrigger acquisition starts on the first B edge after the trigger delay time.

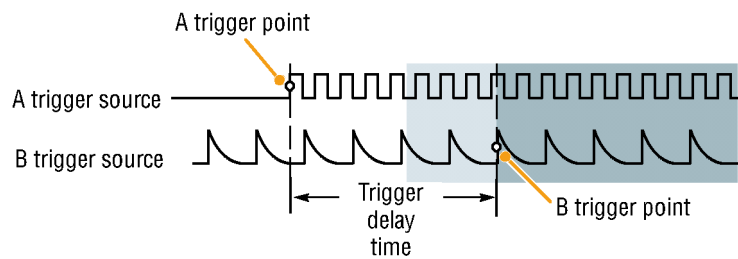

### Trigger on B Events

The A trigger arms the instrument. Posttrigger acquisition starts on the nth B event.

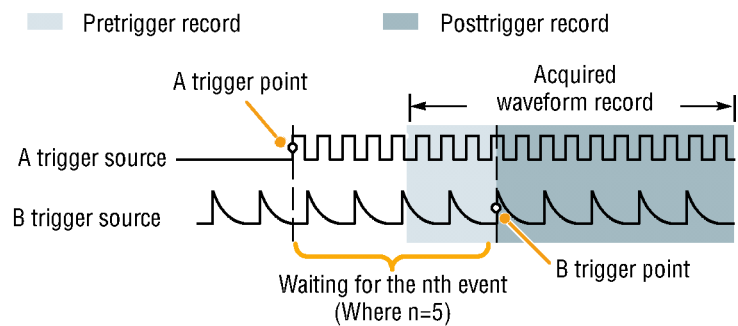

### Quick Tips

- B-trigger delay time and horizontal position are independent functions. When you establish a trigger condition using either the A trigger alone or the A and B triggers together, you can also use the horizontal position control to delay the acquisition by an additional amount.
- When using the B trigger, the A and B trigger types can only be Edge.

## Starting and Stopping an Acquisition

After you have defined the acquisition and trigger parameters, start the acquisition with **Run/Stop** or **Single**.

- Push **Run/Stop** to start acquisitions. The oscilloscope acquires repeatedly until you push the button again to stop the acquisition.
- Push **Single** to take a single acquisition. Single sets the trigger mode to **Normal** for the single acquisition.

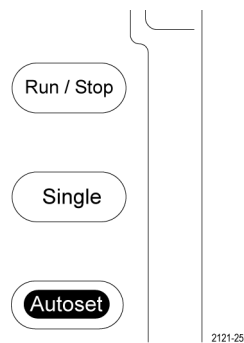

2121-252

# Display Waveform Data

This section contains concepts and procedures for displaying the acquired waveform.

## Adding and Removing a Waveform

1. To add or remove a waveform from the display, push the corresponding front-panel channel button or the D15-D0 button.

You can use the channel as a trigger source whether or not it is displayed.

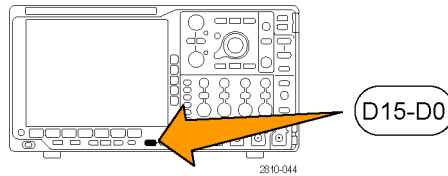
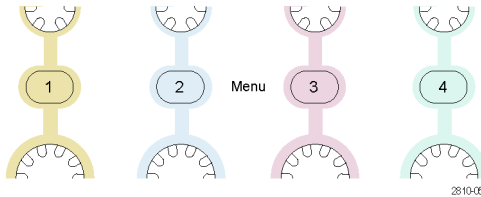

## Setting the Display Style and Persistence

1. To set the display style, push **Acquire**.

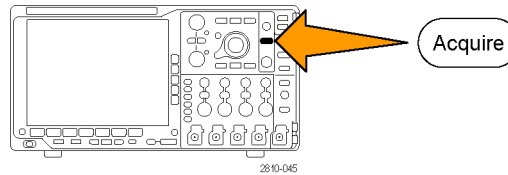

2. Push **Waveform Display**.

Mode <b>Sample</b>	Record Length <b>10k</b>	Delay On <b>Off</b>	Set Horiz. Position to 10%	Waveform Display	XY Display <b>On</b>	
-----------------------	-----------------------------	------------------------	-------------------------------	------------------	-------------------------	--



3. Push **Dots Only On Off** from the side-bezel menu. Dots on will display the waveform record points as dots on the screen. Dots off connects the dots with vectors.

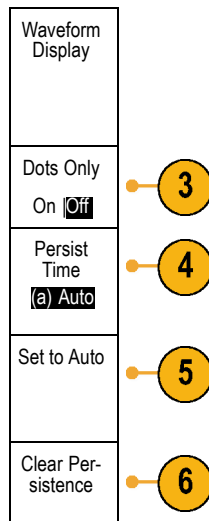

4. Push **Persist Time**, and turn multipurpose knob **a** to have waveform data remain on screen for a user-specified amount of time.

5. Push **Set to Auto** to have the oscilloscope automatically determine a persistence time for you.

6. Push **Clear Persistence** to reset the persistence information.

7. To display the amplitude from one waveform against the amplitude from another, push **XY Display**. Then push **Triggered XY** from the side menu.

A data point from the first waveform specifies the horizontal location while the corresponding data point from the second waveform specifies the vertical location for each displayed point.

### Quick Tips

- Variable persistence accumulates record points for a specified time interval. Each record point decays independently according to the time interval. Use variable persistence for displaying infrequently appearing signal anomalies, such as glitches.
- Infinite persistence continuously accumulates record points until you change one of the acquisition display settings. Use infinite persistence for displaying unique signal anomalies, such as glitches.
- The XY Display mode graphs the data in fixed pairs of waveforms against one another.
- When the XY Display is on, an upper window appears that displays data versus time.

### Setting the Graticule Style

1. To set the graticule style, push **Utility**.

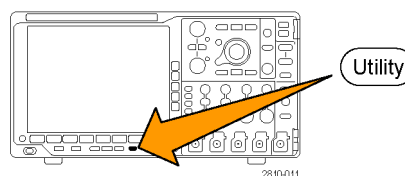

2. Push **Utility Page**.

Utility Page



3. Turn multipurpose knob **a** and select **Display**.

Display

4. Push **Graticule** from the lower-bezel menu.

Utility Page Display	Backlight Intensity High	Graticule Full	Screen Annotation	Trigger Frequency Readout		
-------------------------	-----------------------------	-------------------	-------------------	---------------------------	--	--





5. Select the desired style from the resulting side-bezel menu.

The **Frame** graticule provides a clean screen on which you can most easily read automatic measurement results and other screen text.

The **Full** graticule can help you make cursor measurements on hard copies.

The **Grid**, **Solid**, and **Cross Hair** graticules provide compromises between **Frame** and **Full**.

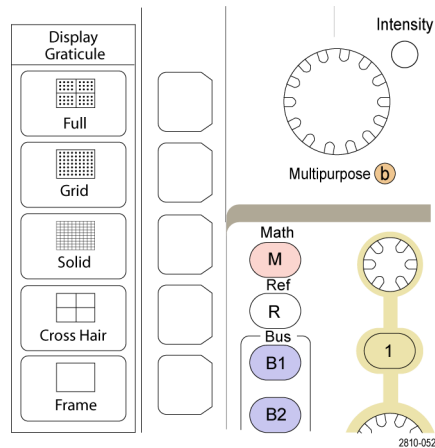

### Quick Tips

- You can display IRE and mV graticules. To do this, set the trigger type to video and set the vertical scale to 114 mV/division. (The 114 mV/division selection is available in the coarse vertical scale settings for the channel when you set the trigger type to video.) The oscilloscope will automatically display the IRE graticule for NTSC signals, and the mV graticule for other video signals (PAL, SECAM, HDTV, and custom).

### Setting the LCD Backlight

1. Push **Utility**.

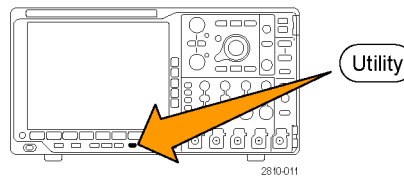

2. Push **Utility Page**.



3. Turn multipurpose knob **a** and select **Display**.



4. Push **Backlight Intensity**.

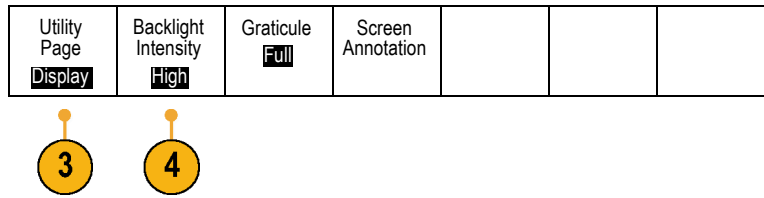

5. Select the intensity level from the resulting side-bezel menu. Choices are: **High**, **Medium**, and **Low**.

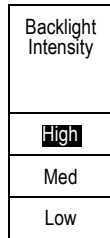

## Setting Waveform Intensity

1. Push the front-panel **Intensity** button.

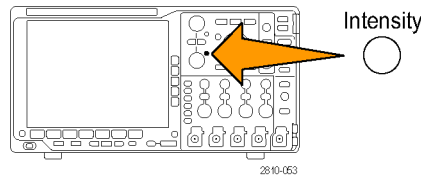

This will bring up the intensity readout on the display.

- a Waveform Intensity: 35%
- b Graticule Intensity: 75%

2. Rotate multipurpose knob **a** to select the desired waveform intensity.

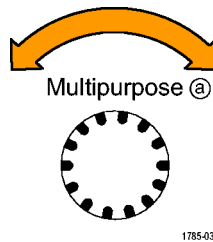

3. Rotate multipurpose knob **b** to select the desired intensity for the graticule.

4. Push **Intensity** again to clear the intensity readout from the display.

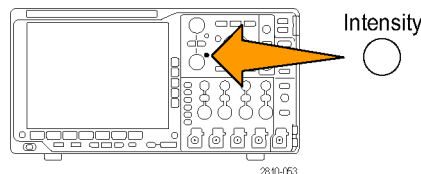

## Scaling and Positioning a Waveform

Use the horizontal controls to adjust the time base, adjust the trigger point, and to examine waveform details more closely. You can also use the Wave Inspector Pan and Zoom controls to adjust the display of waveforms. (See page 122, *Using Wave Inspector to Manage Long Record Length Waveforms.*)

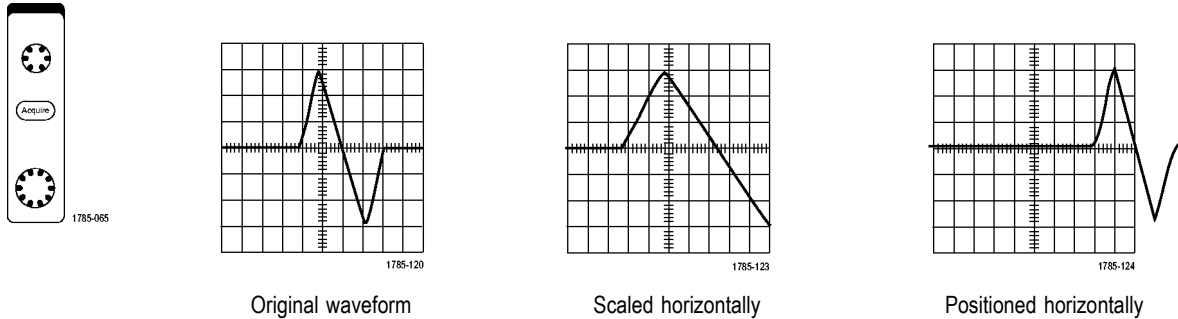

Use the vertical controls to select waveforms, adjust the waveform vertical position and scale, and set input parameters. Push a channel menu button (1, 2, 3, or 4), button as many times as needed and the associated menu items to select, add, or remove a waveform.

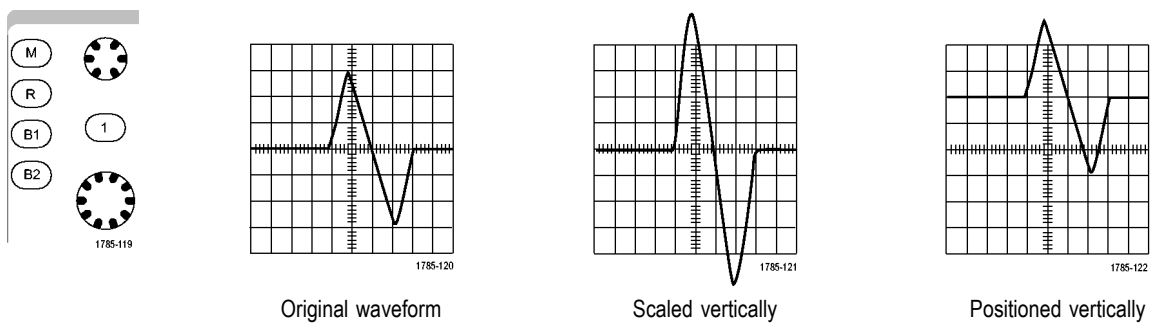

### Quick Tips

- **Preview.** If you change the Position or Scale controls when the acquisition is stopped or when it is waiting for the next trigger, the oscilloscope rescales and repositions the relevant waveforms in response to the new control settings. It simulates what you will see when you next push the **RUN** button. The oscilloscope uses the new settings for the next acquisition.

You may see a clipped waveform if the original acquisition went off the screen.

The math waveform, cursors, and automatic measurements remain active and valid when using preview.

## Setting Input Parameters

Use the vertical controls to select waveforms, adjust the waveform vertical position and scale, and set input parameters.

1. Push a channel menu button **1**, **2**, **3**, or **4** to bring up the vertical menu for the designated waveform. The vertical menu only affects the selected waveform.

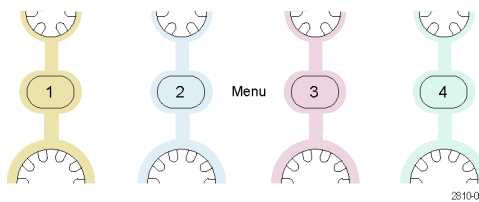

Pushing a channel button will also select or cancel that waveform selection.

2. Push **Coupling** repeatedly to select the coupling to use.  
Use DC coupling to pass both AC and DC components.  
Use AC coupling to block the DC component and show only the AC signal.

Coupling DC AC	Termination 1MΩ 50Ω	Invert On Off	Bandwidth Full	(1) Label		More
-------------------	------------------------	------------------	-------------------	-----------	--	------



3. Push **Termination** repeatedly to select the input impedance to use.  
Set the input impedance (termination) to 50 Ω or 1 MΩ if using DC coupling. Input impedance is automatically set to 1 MΩ when using AC coupling.  
For more information on input impedance, see **Quick Tips**. (See page 93, *Quick Tips*.)
4. Push **Invert** to invert the signal.  
Select **Off** for normal operation and **On** to invert the polarity of the signal in the preamplifier.

5. Push **Bandwidth**, and select the desired bandwidth from the resulting side-bezel menu.

The set choices are: Full, 250 MHz, and 20 MHz. Additional choices may appear, depending on the probe that you use.

Select **Full** to set the bandwidth to the full oscilloscope bandwidth.

Select **250 MHz** to set the bandwidth to 250 MHz.

Select **20 MHz** to set the bandwidth to 20 MHz.

6. Push **Label** to create a label for the channel. (See page 45, *Labeling Channels and Buses*.)
7. For some types of probes, you can push this button to instruct the oscilloscope to perform an AC calibration on the entire signal path from the probe tip to the specific oscilloscope channel. This can result in a flatter frequency response over the entire frequency range.
8. Push **More** to access additional side-bezel menus.

9. Select **Fine Scale** to enable multipurpose knob **a** to make fine vertical scale adjustments.

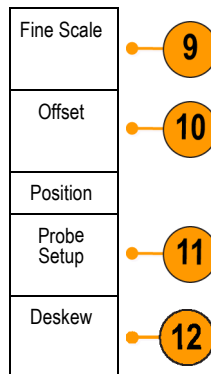

10. Select **Offset** to enable multipurpose knob **a** to make vertical offset adjustments.

On the side-bezel menu, choose **Set to 0 V** to set the vertical offset to 0 V.

For more information on offset, see **Quick Tips**. (See page 93, *Quick Tips*.)

11. Select **Probe Setup** to define probe parameters.

On the resulting side-bezel menu:

- Select **Voltage** or **Current** to set the probe type for probes that do not have a TekProbe Level 1, TekProbe II (requires a TPA-BNC adapter) or TekVPI interface.
- For probes that do not have a Tek interface, when **Probe Type** is set to **Voltage**, use multipurpose knob **a** to set **Attenuation** to match the probe
- For probes that do not have a Tek interface, when **Probe Type** is set to **Current**, use multipurpose knob **a** to set the Amps/Volts ratio (Attenuation) to match the probe.
- If you are measuring current by probing the voltage drop across a resistor, set **Measure Current** to **Yes**. Push **A/V** ratio side-bezel button and turn multipurpose knob **a** to set the Amps/Volts or Volts/Amp ratio of your setup. For example, if you are measuring the drop across a  $2\ \Omega$  resistor, set the V/A ratio to 2.

12. Select **Deskew** to make display and measurement adjustments for probes that have differing propagation delays. This is especially important when using a current probe in conjunction with a voltage probe.

For best results, use a deskew fixture, such as the Tektronix 067-1686-xx.

If you do not have a deskew fixture, you can use the controls in the Deskew menu to set the oscilloscope's deskew parameters to recommended values, based on the nominal propagation delay of each probe. The oscilloscope automatically loads the nominal propagation delay values of TekVPI and TekProbe II (requires use of a TPA-BNC adaptor) probes. For other common probes, first push the side-bezel **Select** button, and select the channel to which the probe is attached. Then push the side-bezel **Probe Model** button, and select the probe model. If your probe is not in the list, set probe model to **Other**, and push the side-bezel **Propagation Delay** button and dial in its propagation delay with multipurpose knob a.

To display the recommended deskew values calculated by the oscilloscope, set the side-bezel **Show rec. deskews** to **Yes**.

To set the deskew values of each channel to the recommended values, push the side-bezel **Set all deskews to recommended values** button.

## Quick Tips

- **Using Probes with the TekProbe II and TekVPI Interfaces.** When you attach a probe with the TekProbe II or the TekVPI interface, the oscilloscope sets the channel sensitivity, coupling, and termination resistance automatically to match the probe requirements. Tek Probe II probes require use of the TPA-BNC Adapter.
- **The Difference Between Vertical Position and Offset.** Adjust the vertical position to place the waveforms where you want to see them. The waveform baseline indicators indicate the zero Volts (or Amps) level for each waveform. If you adjust the channel's Vertical Scale, the waveform expands or contracts around the waveform's baseline indicator.

When you use the Channel<x> > **More** > **Offset** > **Vertical Offset** control to move a waveform, the baseline indicator no longer represents zero. Instead, it represents the level of the offset. If you adjust the channel's Vertical Scale, the waveform expands or contracts around the waveform's baseline indicator.

- **50  $\Omega$  Protection.** If you select 50  $\Omega$  termination, the maximum vertical scale factor is limited to 1 V/div, except that with a 10X probe the scale factor is 10 V. If you apply excessive input voltage, the oscilloscope automatically switches to 1 M $\Omega$  termination to protect the internal 50  $\Omega$  termination. For more details, refer to the specifications in the *MSO4000B and DPO4000B Series Oscilloscopes Technical Reference*.

## Positioning and Labeling Bus Signals

**Positioning bus signals.** Push the appropriate front-panel bus button and turn multipurpose knob **a** to adjust the vertical position of the selected bus. (See page 54, *Setting Up a Serial or Parallel Bus*.)

1. Push the appropriate front-panel bus button to select that bus.

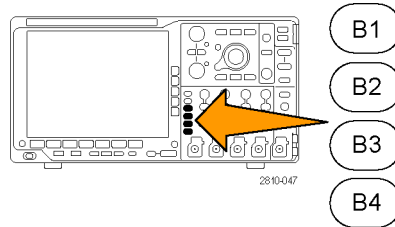

2. Turn multipurpose knob **a** to adjust the vertical position of the selected bus.

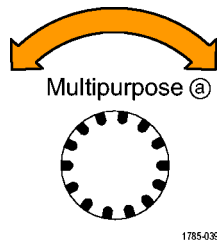

**Labeling bus signals.** To label a bus, do the following steps:

1. Push the appropriate front-panel bus button.

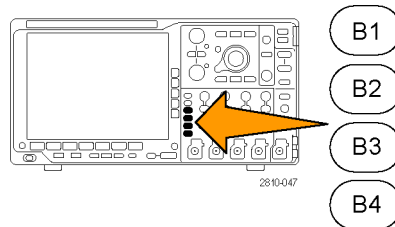

2. Push **Label**.  
(See page 45, *Labeling Channels and Buses*.)

Bus (B1) Parallel	Define Inputs	Thresholds		(B1) Label Parallel	Bus Display	Event Table
----------------------	------------------	------------	--	------------------------	----------------	----------------



## Positioning, Scaling, and Grouping Digital Channels

1. Push the front-panel **D15–D0** button.

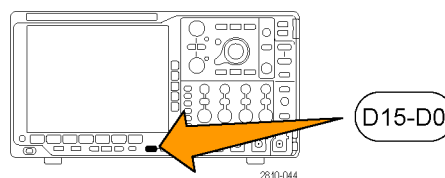



2. Push the lower-bezel **D15–D0** menu item.

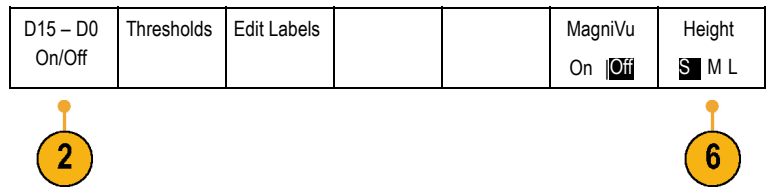

3. Push the side-bezel **Select** button.

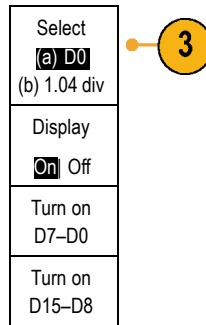

4. Turn multipurpose knob **a** to select the channel to move.

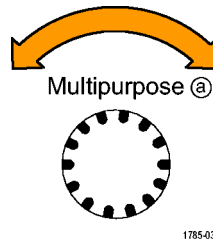

5. Turn multipurpose knob **b** to move the selected channel.

**NOTE.** The display of the channel (or group) only moves after you stop rotating the knob.



6. To change the scale (height) of the digital channels, push the lower-menu **Height** button.

**NOTE.** The **S** (Small) selection will display each waveform at 0.2 divisions tall. The **M** (Medium) selection will display each waveform at 0.5 divisions tall. The **L** (Large) selection will display each waveform at 1 division tall. **L** only works if there is enough room in the display to display the waveforms. You can display up to 10 **L** waveforms at one time.

7. You can label individual digital channels for easier identification. (See page 45, *Labeling Channels and Buses*.)

- To group some or all of the digital channels together, move the channels right next to each other. All the channels that are next to each other automatically form a group.

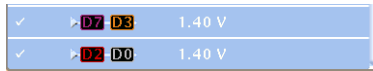

You can see the groups by pushing the side-bezel **Select** item and turning multipurpose knob **a**.

When a group is selected, turn multipurpose knob **b** to move the whole group.

## Viewing Digital Channels

The various ways of displaying data from the digital channels help you analyze the signals. Digital channels store a high or low state for each sample.

Logic high levels are displayed in green. Logic low levels are displayed in blue. When a single transition occurs during the time represented by one pixel column, the transition (edge) is displayed in gray.

When multiple transitions occur during the time represented by one pixel column, the transition (edge) is displayed in white.

When the display shows a white edge, indicating multiple transitions, you may be able to zoom in and see the individual edges.

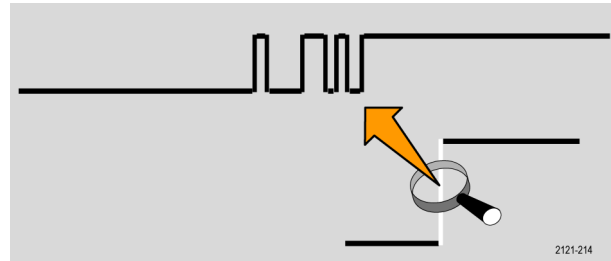

When you are zoomed in so far that there is more than one pixel column per sample, the uncertainty of the edge position is indicated by light gray shading.



**NOTE.** When the light gray shading is displayed, use *MagniVu*.

## Annotating the Screen

You can add your own text to the screen by doing the following:

- Push **Utility**.

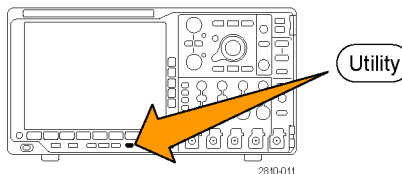

2. Push **Utility Page**.



3. Turn multipurpose knob **a** and select **Display**.



4. Push **Screen Annotation** from the resulting lower-bezel menu.

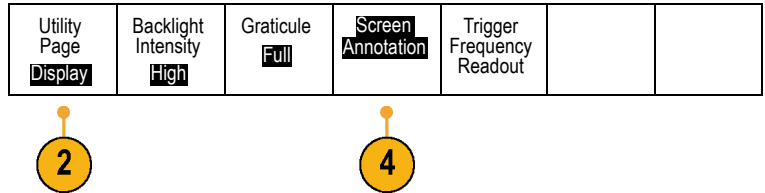

5. Push **Display Annotation** to select **On** from the side-bezel menu.

The annotation window now appears.

Position it by turning multipurpose knobs **a** and **b**.

6. Push **Edit Annotation** from the side-bezel menu
7. Turn multipurpose knob **a** to scroll through the list of letters, numbers, and other characters to select each desired character. Alternatively, use a USB keyboard to type in characters. (See page 27, *Connecting a USB Keyboard to Your Oscilloscope*.)

To reposition the annotated text, push the side-bezel **Position** button and turn multipurpose knobs **a** and **b**, as desired.

## Viewing the Trigger Frequency

You can display a readout of trigger frequency. It counts all of the triggerable events, whether the oscilloscope triggered on them or not, and displays the number of times per second that they occur. To display this readout, do the following:

1. Push **Utility**.

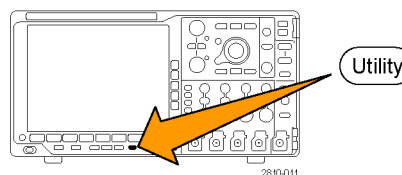

2. Push **Utility Page**.



3. Turn multipurpose knob **a** and select **Display**.



4. Push **Trigger Frequency Readout** from the resulting lower-bezel menu.

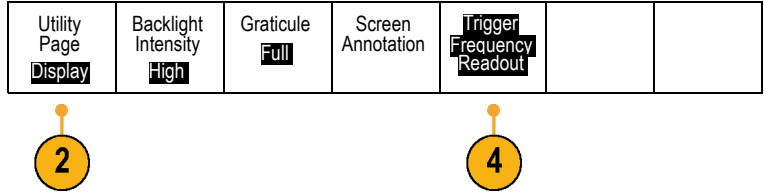

5. Push **On** from the side-bezel menu.

The trigger frequency now appears in the Trigger readout, toward the lower right of the display.

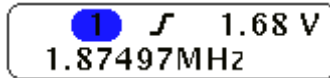

# Analyze Waveform Data

After having properly set up the acquisition, triggering, and display of your desired waveform, you can then analyze the results. Select from features such as cursors, automatic measurements, statistics, waveform histograms, math, and FFT.

## Taking Automatic Measurements

To take an automatic measurement:

1. Push **Measure**.

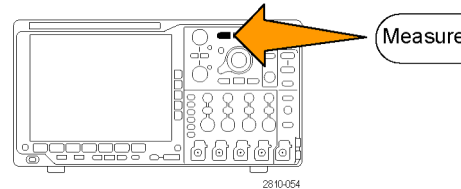

2. Push **Add Measurement**.

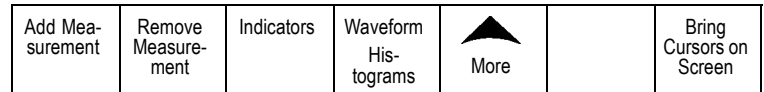

3. Turn multipurpose knob **a** to select the specific measurement. If needed, then turn multipurpose knob **b** to select the channel to measure on.

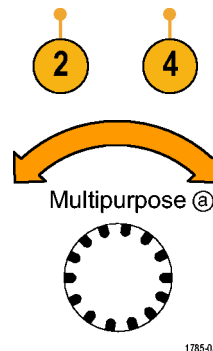

4. To remove a measurement, push **Remove Measurement**, turn multipurpose knob **a** to select the specific measurement, and push **OK Remove Measurement** on the side-bezel menu.







### Quick Tips

- To remove all measurements, select **Remove All Measurements**.
- A  symbol appears instead of the expected numerical measurement if a vertical clipping condition exists. Part of the waveform is above or below the display. To obtain a proper numerical measurement, turn the vertical scale and position knobs to make all of the waveform appear in the display.

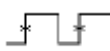

## Selecting Automatic Measurements

The following tables list each automatic measurement by category: time or amplitude. (See page 99, *Taking Automatic Measurements*.)

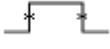
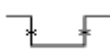
### Time measurements



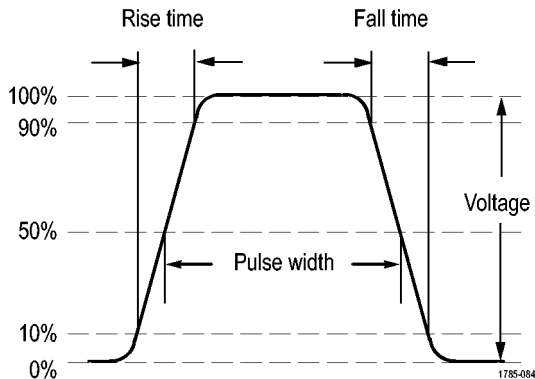

Measurement		Description
Period		The time required to complete the first cycle in a waveform or gated region. Period is the reciprocal of frequency and is measured in seconds.
Frequency		The first cycle in a waveform or gated region. Frequency is the reciprocal of the period; it is measured in hertz (Hz) where one Hz is one cycle per second.
Delay		The time between the mid reference (default 50%) amplitude point of two different waveforms. See also <i>Phase</i> .
Rise Time		The time required for the leading edge of the first pulse in the waveform or gated region to rise from the low reference value (default = 10%) to the high reference value (default = 90%) of the final value.
Fall Time		The time required for the falling edge of the first pulse in the waveform or gated region to fall from the high reference value (default = 90%) to the low reference value (default = 10%) of the final value.
Positive Duty Cycle		The ratio of the positive pulse width to the signal period expressed as a percentage. The duty cycle is measured on the first cycle in the waveform or gated region.
Negative Duty Cycle		The ratio of the negative pulse width to the signal period expressed as a percentage. The duty cycle is measured on the first cycle in the waveform or gated region.
Positive Pulse Width		The distance (time) between the mid reference (default 50%) amplitude points of a positive pulse. The measurement is made on the first pulse in the waveform or gated region.
Negative Pulse Width		The distance (time) between the mid reference (default 50%) amplitude points of a negative pulse. The measurement is made on the first pulse in the waveform or gated region.

## Time measurements (cont.)



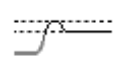
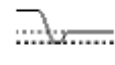



Measurement		Description
Burst Width		The duration of a burst (a series of transient events) and is measured over the entire waveform or gated region.
Phase		The amount of time that one waveform leads or lags another waveform, expressed in degrees where 360° makes up one waveform cycle. See also <i>Delay</i> .



## Amplitude measurements



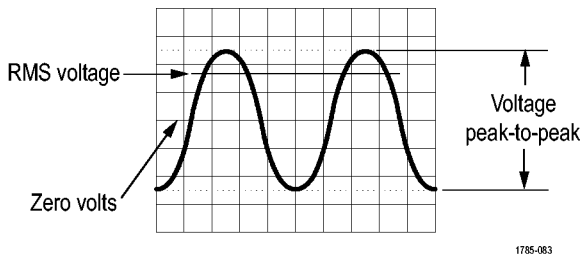

Measurement		Description
Positive Overshoot		This is measured over the entire waveform or gated region and is expressed as: Positive Overshoot = (Maximum – High) / Amplitude x 100%.
Negative Overshoot		This is measured over the entire waveform or gated region and is expressed as: Negative Overshoot = (Low – Minimum) / Amplitude x 100%.
Pk-Pk		The absolute difference between the maximum and minimum amplitude in the entire waveform or gated region.
Amplitude		The high value less the low value measured over the entire waveform or gated region.
High		This value is used as 100% whenever high reference, mid reference, or low reference values are needed, such as in fall time or rise time measurements. Calculate using either the min/max or histogram method. The min/max method uses the maximum value found. The histogram method uses the most common value found above the midpoint. This value is measured over the entire waveform or gated region.
Low		This value is used as 0% whenever high reference, mid reference, or low reference values are needed, such as in fall time or rise time measurements. Calculate using either the min/max or histogram method. The min/max method uses the minimum value found. The histogram method uses the most common value found below the midpoint. This value is measured over the entire waveform or gated region.

### Amplitude measurements (cont.)

Measurement		Description
Max		The most positive peak voltage. Max is measured over the entire waveform or gated region.
Min		The most negative peak voltage. Min is measured over the entire waveform or gated region.
Mean		The arithmetic mean over the entire waveform or gated region.
Cycle Mean		The arithmetic mean over the first cycle in the waveform or the first cycle in the gated region.
RMS		The true Root Mean Square voltage over the entire waveform or gated region.
Cycle RMS		The true Root Mean Square voltage over the first cycle in the waveform or the first cycle in the gated region.





### Miscellaneous measurements

Measurement		Description
Rising Edge Count		The number of positive transitions from the low reference value to the high reference value in the waveform or gated region.
Falling Edge Count		The number of negative transitions from the high reference value to the low reference value in the waveform or gated region.
Positive Pulse Count		The number of positive pulses that rise above the mid reference crossing in the waveform or gated region.
Negative Pulse Count		The number of negative pulses that fall below the mid reference crossing in the waveform or gated region.



### Miscellaneous measurements (cont.)

Measurement		Description
Area		Area measurement is a voltage over time measurement. It returns the area over the entire waveform or gated region in volt-seconds. Area measured above ground is positive; area measured below ground is negative.
Cycle Area		A voltage over time measurement. The measurement is the area over the first cycle in the waveform or the first cycle in the gated region expressed in volt-seconds. The area above the common reference point is positive, and the area below the common reference point is negative.

### Histogram measurements

Measurement	Description
Waveform Count	Displays the number of waveforms that contributed to the histogram.
Hits in Box	Displays the number of samples within the histogram box or on its boundaries.
Peak Hits	Displays the number of samples in the bin that contains the most hits.
Median	Displays the middle histogram data value, where half of all histogram data points are less than this value and half are greater than this value.
Peak-to-peak	Displays the peak-to-peak value of the histogram. Vertical histograms display the voltage of the highest nonzero bin minus the voltage of the lowest nonzero bin. Horizontal histograms display the time of the rightmost nonzero bin minus the time of the leftmost nonzero bin.
Histogram Max	Displays the voltage of the highest nonzero bin in vertical histograms or the time of the rightmost nonzero bin in horizontal histograms.
Histogram Min	Displays the voltage of the lowest nonzero bin in vertical histograms or the time of the leftmost nonzero bin in horizontal histograms.
Histogram Mean	Measures the average of all histogram data points within or on the histogram box.
Standard Deviation	Measures the standard deviation (Root Mean Square (RMS) deviation) of all histogram data points within or on the histogram box.
Sigma1	Displays the percentage of the hits in the histogram that are within one standard deviation of the histogram mean.
Sigma2	Displays the percentage of the hits in the histogram that are within two standard deviations of the histogram mean.
Sigma3	Displays the percentage of the hits in the histogram that are within three standard deviations of the histogram mean.

## Customizing an Automatic Measurement

You can customize automatic measurements by using gating, modifying measurement statistics, adjusting the measurement reference levels, or taking a snapshot.

### Gating

Gating confines the measurement to a certain portion of a waveform. To use:

1. Push **Measure**.

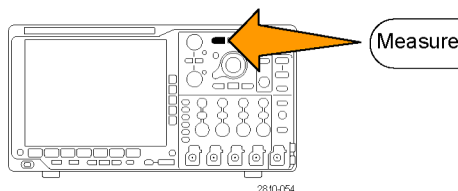

2. Push **More** as many times as needed to select **Gating** from the resulting pop-up menu.

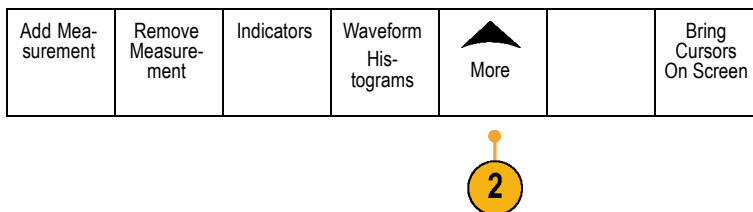

- Position the gates from the side-bezel menu options.

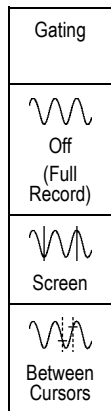

### Statistics

Statistics characterize the stability of measurements. To adjust statistics:

- Push **Measure**.

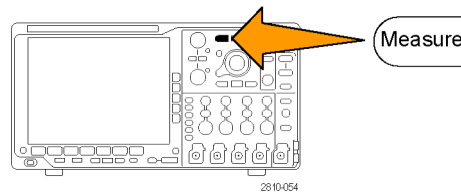

- Push **More** as many times as needed to select **Statistics** from the resulting pop-up menu.

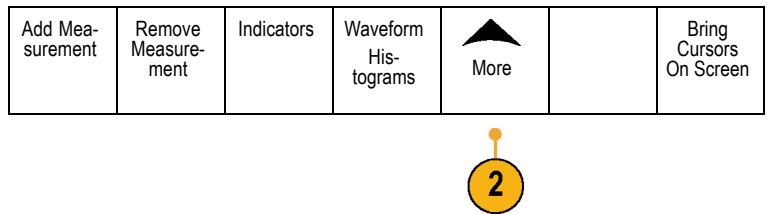

- Push the side-bezel menu options. These include whether to turn statistics on or off and how many samples to use for mean and standard deviation calculations.

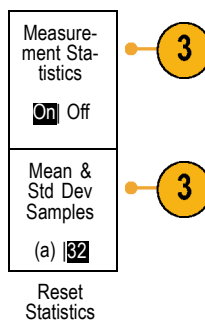

## Snapshot

To see all the single-sourced measurements at one moment in time:

1. Push **Measure**.

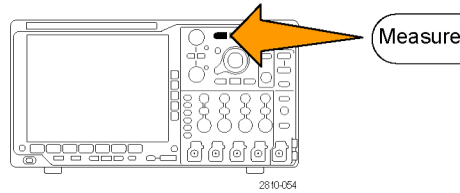

2. Push **Add Measurement**.

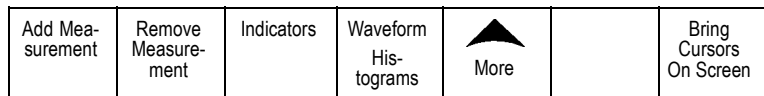

3. Turn multipurpose knob **a** to select the desired **Source** channel.

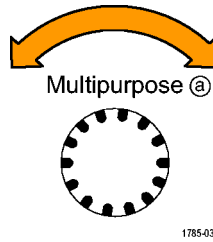

4. Turn multipurpose knob **b** to select the **Measurement Type of Snapshot**.

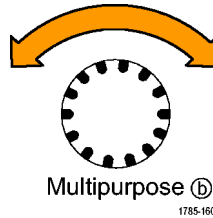

5. Push **OK Snapshot All Measurements**.

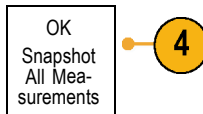

## 6. View results.

Snapshot on 1

Period	: 312.2 $\mu$ s	Freq	: 3.203 kHz
+Width	: 103.7 $\mu$ s	-Width	: 208.5 $\mu$ s
Burst W	: 936.5 $\mu$ s		
Rise	: 1.452 $\mu$ s	Fall	: 1.144 $\mu$ s
+Duty	: 33.23%	-Duty	: 66.77 %
+Over	: 7.143%	-Over	: 7.143 %
High	: 9.200 V	Low	: -7.600 V
Max	: 10.40 V	Min	: -8.800 V
Ampl	: 16.80 V	Pk-Pk	: 19.20 V
Mean	: -5.396 V	CycleMean	: -5.396 V
RMS	: 7.769 V	CycleRMS	: 8.206 V
Area	: -21.58 mVs	CycleArea	: -654.6 $\mu$ Vs
+Edges	: 1	-Edges	: 0
+Pulses	: 2	-Pulses	: 2

## Reference Levels

Reference levels determine how time-related measurements are taken. For example, they are used in calculating rise and fall times.

1. Push **Measure**.

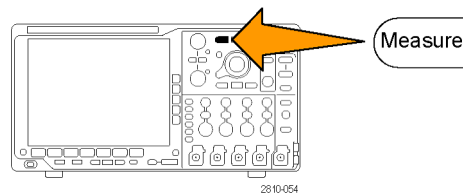

2. Push **More** as many times as needed to select **Reference Levels** from the resulting pop-up menu.

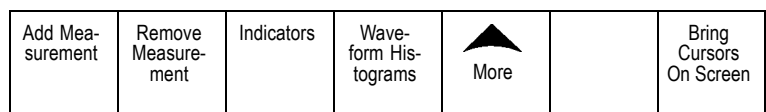

2

3. Set the levels from the side-bezel menu.

Use High and Low reference to calculate rise and fall times.

Use Mid reference primarily for measurements between edges such as pulse widths.

Reference Levels
Set Levels in % <b>Units</b>
High Ref <b>(a) 90.0 %</b>
Mid Ref <b>50.0 %</b> <b>50.0 %</b>
Low Ref <b>10.0 %</b>
- Set to Defaults

## Taking Manual Measurements with Cursors

Cursors are on-screen markers that you position in the waveform display to take manual measurements on acquired data. They appear as horizontal and/or as vertical lines. To use cursors on analog or digital channels:

1. Push **Cursors** to turn cursors on.

**NOTE.** A second push turns cursors off. You can also push and hold **Cursors** to display the cursor menu.

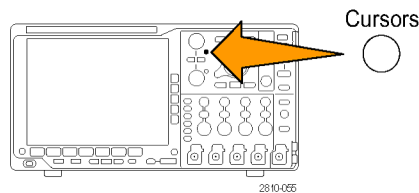

In this example, two vertical cursors appear on the selected waveform. As you turn multipurpose knob **a**, you move one cursor to the right or left. As you turn knob **b**, you move the other cursor.

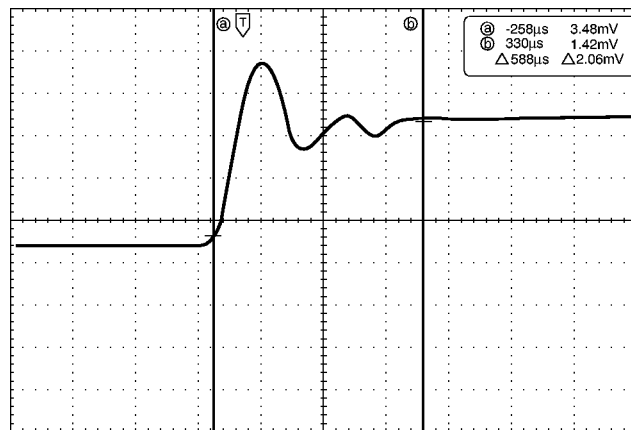

- With cursors on, push **Select**.

This turns the cursor linking on and off. If linking is on, turning multipurpose knob **a** moves the two cursors together. Turning multipurpose knob **b** adjusts the time between the cursors.

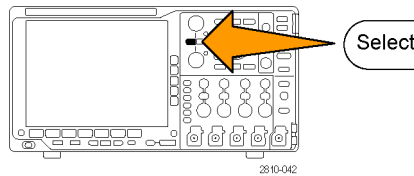

- Push **Fine** to toggle between a coarse and a fine adjustment for multipurpose knobs **a** and **b**.

Pushing **Fine** also changes the sensitivity of other knobs as well.

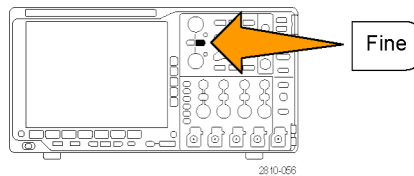

- Push and hold **Cursors** to display the cursor menu.

- Push the **Cursors** lower-bezel button to set the cursors to **Screen**.

In screen mode, two horizontal bars and two vertical bars span the graticule.

Cursors Waveform <b>Screen</b>	Source <b>Auto</b>	Bars Horizontal Vertical	Linked On <b>Off</b>	Bring Cursors On Screen	Cursor Units	
--------------------------------------	-----------------------	--------------------------------	-------------------------	-------------------------------	-----------------	--

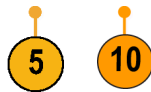

- Turn multipurpose knobs **a** and **b** to move the pair of horizontal cursors.

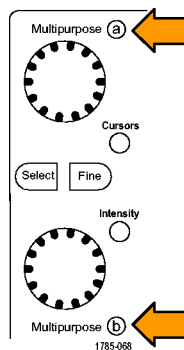

- Push **Select**.

This makes the vertical cursors active and the horizontal cursors inactive. Now, as you turn the multipurpose knobs, the vertical cursors will move.

Push **Select** to make the horizontal cursors active again.

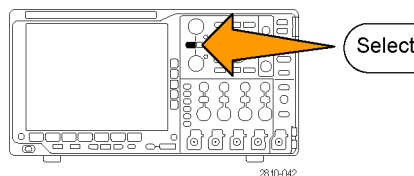

8. View the cursor and the cursor readout.

**NOTE.** On digital channels, you can take timing measurements with cursors, but not amplitude measurements.

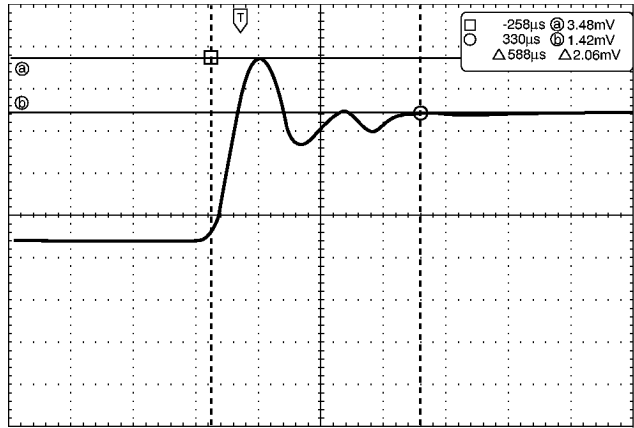

1785-147

9. Display multiple waveforms on the screen by pushing one or more of the channel 1 through 4 buttons or, if you are using an MSO4000B, by pushing the **D15 – D0** button.

10. Push and hold **Cursors** to display the cursor menu again.

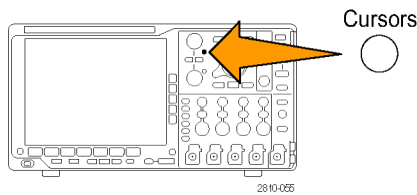

11. Push **Source** from the lower-bezel menu. A pop-up menu will appear. The default menu selection of **Auto** will cause the cursors to take measurements on the selected (last used) waveform.

12. Turn multipurpose knob **a** to choose a channel to measure other than the one pointed to by **Auto**.

13. Push **Menu Off** to remove the pop-up menu.

14. Turn multipurpose knob **a** and take cursor measurements on the alternate waveform.

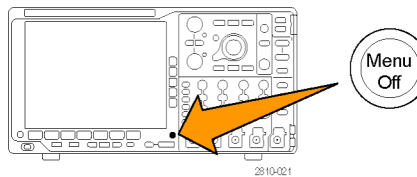



15. Push **Cursors** again. This turns off the cursors. The screen no longer displays the cursors and the cursor readout.

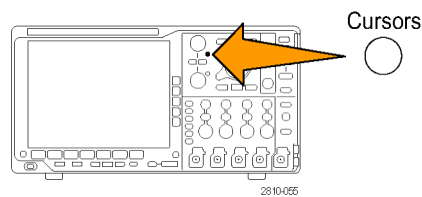

## Using Cursor Readouts

Cursor readouts supply textual and numeric information relating to the current cursor positions.

Readouts appear in the upper right corner of the graticule. If Zoom is on, the readout appears in the upper right corner of the zoom window.

When a bus is selected, the readout shows the decoded bus data in the format you have selected from the choices in the bus menu. When a digital channel is selected, the cursors show the values of all displayed digital channels.

---

**NOTE.** When serial buses are selected, the data value at that point is displayed in the cursor readout.

---

$\Delta$  Readout:

The  $\Delta$  readouts indicate the difference between the cursor positions.

a Readout:

Indicates that the value is controlled by multipurpose knob **a**.

b Readout:

Indicates that the value is controlled by multipurpose knob **b**.

The horizontal cursor lines on the display measure the vertical parameters, typically voltage.

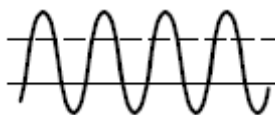
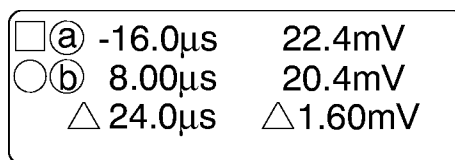

The vertical cursor lines on the display measure horizontal parameters, typically time.



The square and circle shapes in the readout map to the multipurpose knobs when both vertical and horizontal cursors are present.

### Using XY Cursors

When the XY Display mode is on, the cursor readouts will appear to the right of the lower graticule (XY). They will include rectangular, polar, product, and ratio readouts. The oscilloscope will display vertical-bar waveform cursors in the upper graticule (YT).

## Setting Up a Histogram

You can display a vertical (voltage) or horizontal (time) histogram. Use histogram measurements to get statistical measurement data for a section of a waveform along one axis. The sources for a histogram can be any of the four analog channels, a math waveform, or any of the four reference waveforms.

### To Display a Histogram

1. Set up the oscilloscope to show the waveform on which to measure the histogram. Use **Autoset** if appropriate.

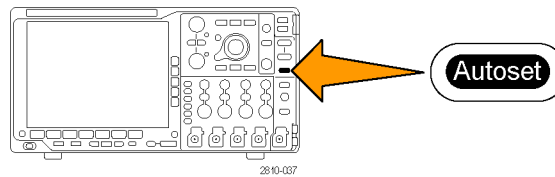

2. Push **Measure**.

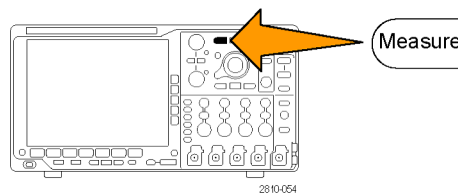

3. Push the **Waveform Histograms** lower-bezel button.

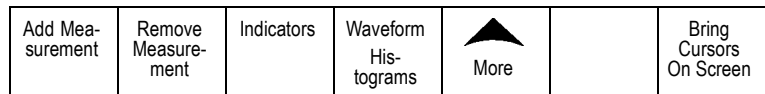

4. Push the top side-bezel button to select the waveform axis for which you want to show the histogram values: **Vertical** or **Horizontal**.
5. Push the **Source** side-bezel button and use multipurpose knob **a** to select the channel for which to display histogram measurements.
6. Push the **Horiz. Limits** side-bezel button and use the multipurpose knobs **a** and **b** to set the **L** (left) and **R** (right) boundaries of the histogram box.
7. Push the **Vert. Limits** side-bezel button and use the multipurpose knobs **a** and **b** to set the **T** (top) and **B** (bottom) boundaries of the histogram box.
8. Push - more - 1 of 2.

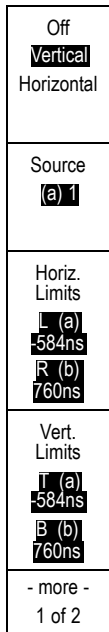

9. Push the **Display** side-bezel button and select **Linear** or **Log**.

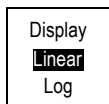

### To Add Measurements on Histogram Data

1. Push the **Add Measurement** lower-bezel button to add measurements on the histogram data.

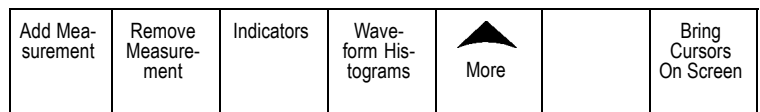

2. Push the **Source** side-bezel button and turn multipurpose knob **a** to select **H** for histogram measurements.
3. Push the **Measurement Type** side-bezel button and turn multipurpose knob **b** to select a histogram measurement.

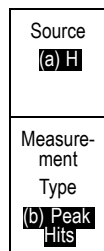

4. Push the **OK Add Measurement** side-bezel button to add the measurement to the measurement readout list.

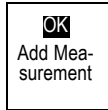

### To Reset Histogram Measurements and Statistics

To reset the histogram measurements and statistics, follow these steps:

1. Push the **Waveform Histograms** lower-bezel button.

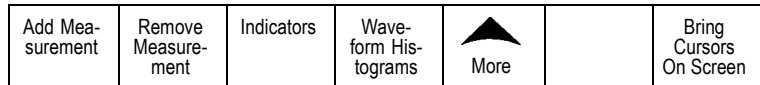

2. Push the **- more - 1 of 2** side-bezel button.

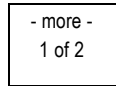

3. Push the **Reset Histogram Counts** side-bezel button.

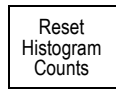

4. Push the **More** lower-bezel button.

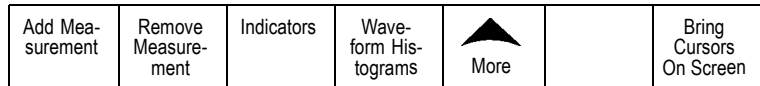

5. Push the **Reset Statistics** side-bezel button.

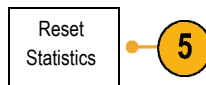

You can view the histogram at the top (for horizontal histograms) or the left edge (for vertical histograms) of the graticule.

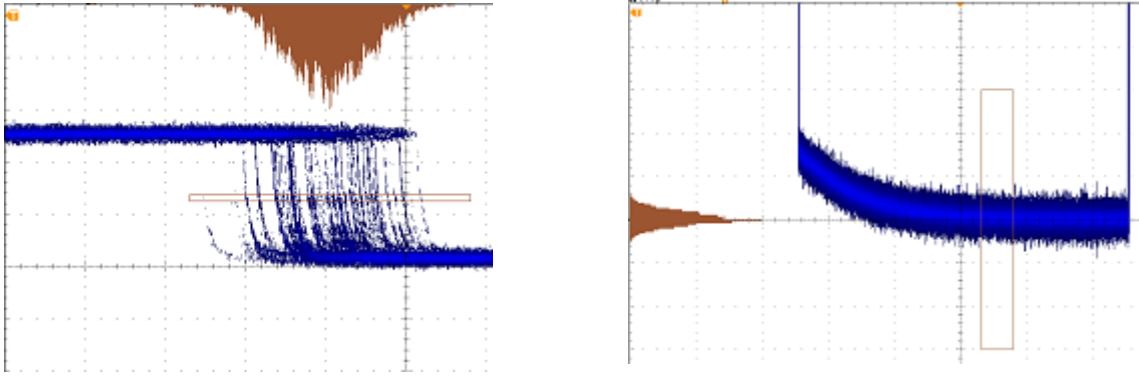

### Quick Tips

- Use horizontal histograms to measure signal jitter.
- Use vertical histograms to measure signal noise.

## Using Math Waveforms

Create math waveforms to support the analysis of your channel and reference waveforms. By combining and transforming source waveforms and other data into math waveforms, you can derive the data view that your application requires.

**NOTE.** Math waveforms are not available for use with serial buses.

Use the following procedure for executing simple (+, -, \*, ÷) math operations on two waveforms:

1. Push **Math**.

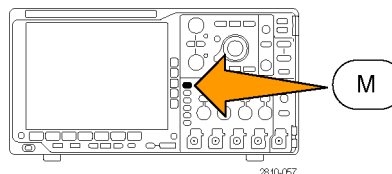

2. Push **Dual Wfm Math**.

Dual Wfm Math	FFT	Advanced Math		(M) Label		
---------------	-----	---------------	--	-----------	--	--



3. On the side-bezel menu, set the sources to either channel **1**, **2**, **3**, **4**, or reference waveforms **R1**, **2**, **3**, or **4**. Choose the **+**, **-**, **x**, or **÷** operators.
4. For example, you might calculate power by multiplying a voltage waveform and a current waveform.

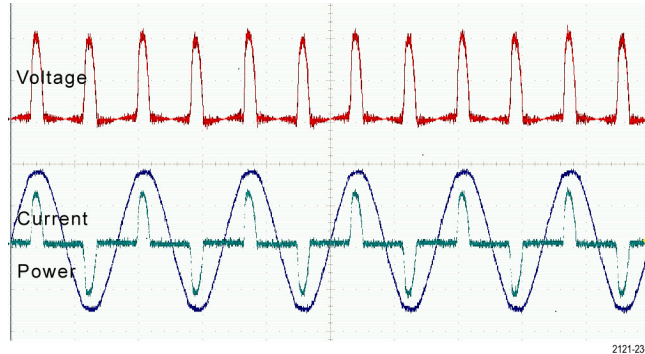

### Quick Tips

- Math waveforms can be created from channel or reference waveforms or a combination of them.
- Measurements can be taken on math waveforms in the same way as on channel waveforms.
- Math waveforms derive their horizontal scale and position from the sources in their math expressions. Adjusting these controls for the source waveforms also adjusts the math waveform.
- You can zoom in on math waveforms using the inner knob of the Pan-Zoom control. Use the outer knob for positioning the zoomed area. (See page 122, *Using Wave Inspector to Manage Long Record Length Waveforms*.)

## Using FFT

An FFT breaks down signals into component frequencies, which the oscilloscope uses to display a graph of the frequency domain of a signal, as opposed to the oscilloscope's standard time domain graph. You can match these frequencies with known system frequencies, such as system clocks, oscillators, or power supplies.

1. Push **Math**.

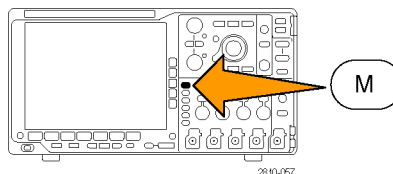

2. Push **FFT**.

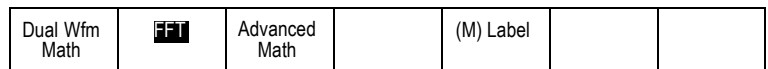

3. Push the side-bezel menu **FFT Source** button, if needed, and turn multipurpose knob **a** to select the source to use. Choices are: channels 1, 2, 3, 4, reference waveforms 1, 2, 3, and 4.
4. Push the side-bezel **Vertical Scale** button repeatedly to select either Linear RMS or dBV RMS.
5. Push the side-bezel **Window** button repeatedly to select the desired window. Window choices are: Rectangular, Hamming, Hanning, and Blackman-Harris.
6. Push the side-bezel **Horizontal** button to activate multipurpose knobs **a** and **b** to pan and zoom the FFT display.

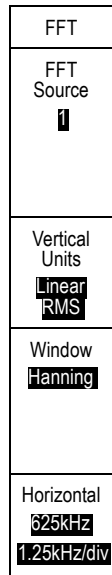

7. The FFT will appear on the display.

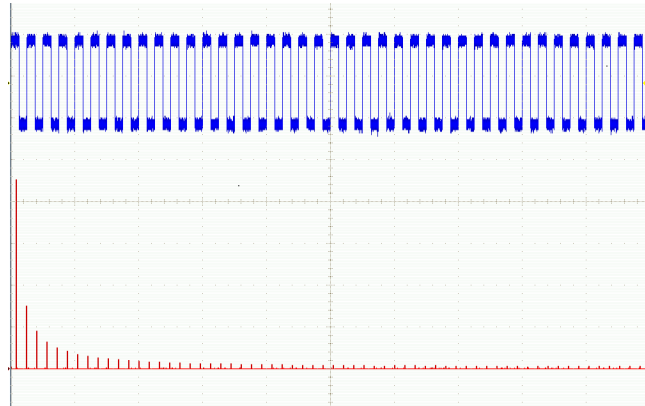

### Quick Tips

- Use short record lengths for faster instrument response.
- Use long record lengths to lower the noise relative to the signal and increase the frequency resolution.
- If desired, use the zoom feature along with the horizontal **Position** and **Scale** controls to magnify and position the FFT waveform.
- Use the default dBV RMS scale to see a detailed view of multiple frequencies, even if they have very different amplitudes. Use the linear RMS scale to see an overall view of how all frequencies compare to each other.
- The FFT feature provides four windows. Each is a trade-off between frequency resolution and magnitude accuracy. What you want to measure and your source signal characteristics help determine which window to use. Use the following guidelines to select the best window.

#### Description

#### Window

##### Rectangular

This is the best type of window for resolving frequencies that are very close to the same value but worst for accurately measuring the amplitude of those frequencies. It is the best type for measuring the frequency spectrum of nonrepetitive signals and measuring frequency components near DC.

Use Rectangular for measuring transients or bursts where the signal level before and after the event are nearly equal. Also, use this window for equal-amplitude sine waves with frequencies that are very close and for broadband random noise with a relatively slow varying spectrum.



##### Hamming

This is a very good window for resolving frequencies that are very close to the same value with somewhat improved amplitude accuracy over the rectangular window. It has a slightly better frequency resolution than the Hanning.

Use Hamming for measuring sine, periodic, and narrow band random noise. This window works on transients or bursts where the signal levels before and after the event are significantly different.





**Description****Window****Hanning**

This is a very good window for measuring amplitude accuracy but less so for resolving frequencies.

Use Hanning for measuring sine, periodic, and narrow band random noise. This window works on transients or bursts where the signal levels before and after the event are significantly different.

**Blackman-Harris:**

This is the best window for measuring the amplitude of frequencies but worst at resolving frequencies.

Use Blackman-Harris for measuring predominantly single frequency waveforms to look for higher order harmonics.



## Using Advanced Math

The advanced math feature lets you create a custom math waveform expression that can incorporate active and reference waveforms, measurements, and/or numeric constants. To use this feature:

1. Push **Math**.

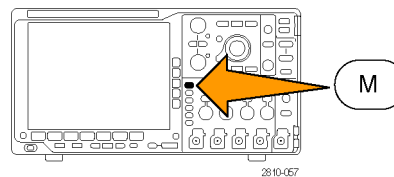

2. Push **Advanced Math**.

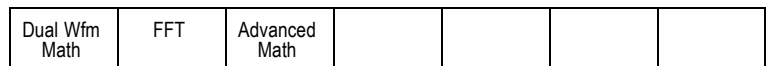

3. Use the side-bezel menu buttons to create custom expressions.

4. Push **Edit Expression** and use the multipurpose knobs and the resulting lower-bezel buttons to create an expression. When done, push the side-bezel menu **OK Accept** button.

For example, to use **Edit Expression** to take the integral of a square wave:

1. Push the lower-bezel **Clear** button.
2. Turn multipurpose knob **a** to select **Intg(**.
3. Push **Enter Selection**.
4. Turn multipurpose knob **a** to select channel 1.
5. Push **Enter Selection**.
6. Turn multipurpose knob **a** to select **)**.
7. Push **OK Accept**.

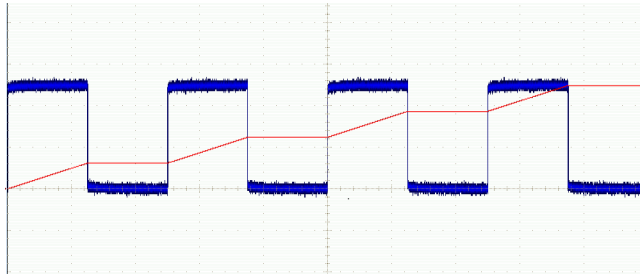

## Using Reference Waveforms

Create a reference waveform to store a waveform. For example, you might do this to set up a standard against which to compare other waveforms. To use the reference waveforms:

---

**NOTE.** 5M, 10 M and 20 M reference waveforms are volatile and not saved when the oscilloscope power is turned off. To keep these waveforms, save them to external storage.

---

1. Push **Ref R**. This brings up the lower-bezel reference menu.

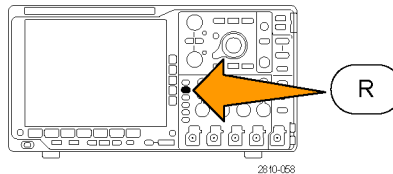

2. Use the resulting lower-bezel menu selections to display or select a reference waveform.

(R1) <b>[[On]</b> 3-May-07	(R2) <b>[[Off]</b>	(R3) <b>[[Off]</b>	(R4) <b>[[Off]</b>			
-------------------------------	--------------------	--------------------	--------------------	--	--	--



- Use the side-bezel menu and the multipurpose knobs to adjust the vertical and horizontal settings of the reference waveform.

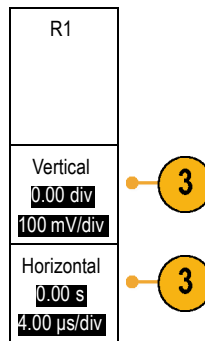

### Quick Tips

- **Selecting and Displaying Reference Waveforms.** You can display all the reference waveforms at the same time. Push the appropriate screen button to select a particular reference waveform.
- **Removing Reference Waveforms from the Display.** To remove a reference waveform from the display, push the front-panel **R** button to access the lower-bezel menu. Then push the associated button from the lower-bezel menu to turn it off.
- **Scaling and Positioning a Reference Waveform.** You can position and scale a reference waveform independently from all other displayed waveforms. Select the reference waveform and then adjust it with a multipurpose knob. You can do this whether acquisition is running or not.

If a reference waveform is selected, scaling and repositioning of the reference waveform operates the same way whether zoom is turned on or off.

- **Saving 5M, 10 M and 20 M Reference Waveforms.** 5M, 10 M and 20 M reference waveforms are volatile and not saved when the oscilloscope power is turned off. To keep these waveforms, save them to external storage.

## Using Wave Inspector to Manage Long Record Length Waveforms

The Wave Inspector controls (zoom/pan, play/pause, marks, search) help you to efficiently work with long record length waveforms. To magnify a waveform horizontally, turn the Zoom knob. To scroll through a zoomed waveform, turn the Pan knob.

The Pan-Zoom Control consists of:

1. An outer pan knob
2. An inner zoom knob

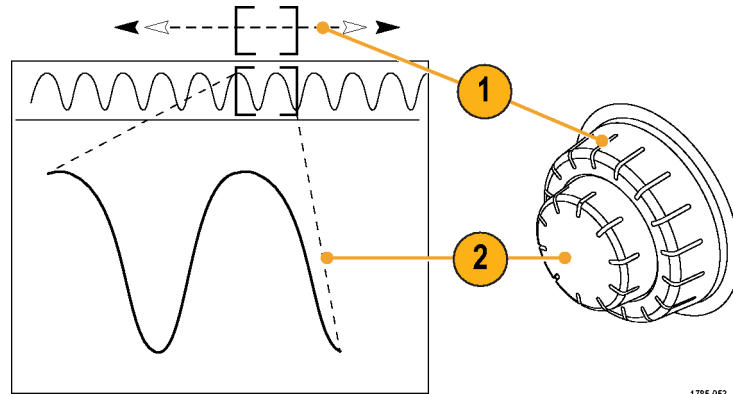

1785-053

### Zooming a Waveform

To use zoom:

1. Rotate the inner knob on the Pan-Zoom control clockwise to zoom in on a selected portion of the waveform. Rotate the knob counterclockwise to zoom back out.

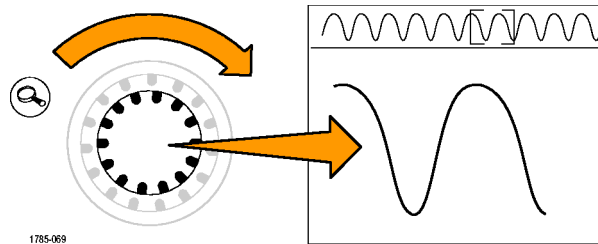

1785-069

2. Alternatively, enable or disable the zoom mode by pushing the zoom button.

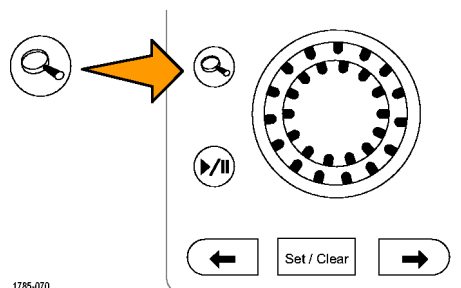

1785-070

3. Examine the zoomed view of the waveform that appears on the larger, lower portion of the display. The upper portion of the display will show the position and size of the zoomed portion in the waveform, within the context of the overall record.

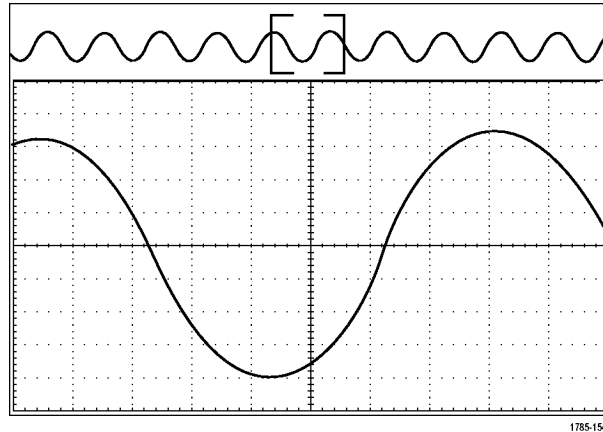

### Panning a Waveform

While the zoom feature is on, you can use the pan feature to quickly scroll through the waveform. To use pan:

1. Rotate the pan (outer) knob of the pan-zoom controls to pan the waveform.  
Turn the knob clockwise to pan forward. Turn it counterclockwise to pan backwards. The further you turn the knob, the faster the zoom window pans.

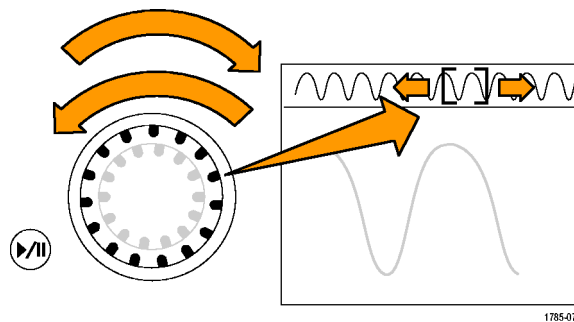

### Playing and Pausing a Waveform

Use the play-pause feature to automatically pan through a waveform record. To use it:

1. Enable the play-pause mode by pushing the play-pause button.
2. Adjust the play speed by turning the pan (outer) knob further. The further you turn it, the faster it goes.

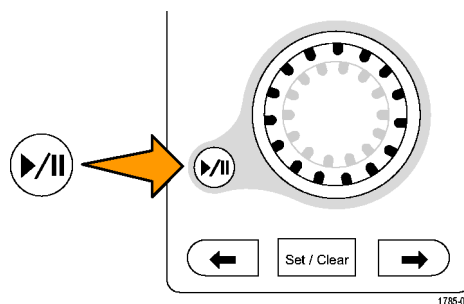

3. Change the play direction by reversing the direction that you are turning the pan knob.
4. During play, up to a point, the more you turn the ring, the faster the waveform accelerates. If you rotate the ring as far as it can go, the play speed does not change, but the zoom box quickly moves in that direction. Use this maximum rotation feature to replay a portion of the waveform that you just saw and want to see again.
5. Pause the play-pause feature by pushing the play-pause button again.

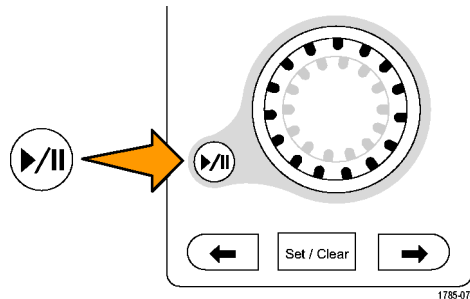

## Searching and Marking Waveforms

You can mark locations of interest in the acquired waveform. These marks help you limit your analysis to particular regions of the waveform. You can mark areas of the waveform automatically, if they meet some special criteria, or you can manually mark each item of interest. You can use arrow keys to jump from mark to mark (area of interest to area of interest). You can automatically search and mark many of the same parameters that you can trigger on.

Search marks provide a way to mark a waveform region for reference. You can set marks automatically with search criteria. You can search for and mark regions with particular edges, pulse widths, runts, logic states, rise/fall times, setup and hold, and bus search types.

To manually set and clear (delete) marks:

1. Move (the zoom box) to the area on the waveform where you want to set (or clear) a search mark by turning the pan (outer) knob.  
Push the next (→) or previous (←) arrow button to jump to an existing mark.

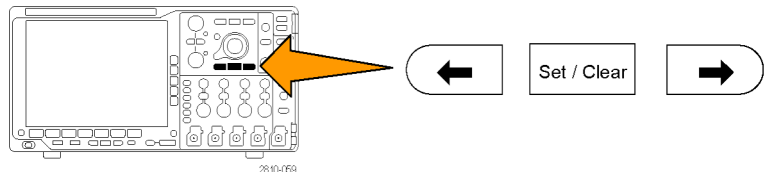

2. Push **Set/Clear**.  
If no search mark is at the screen center, the oscilloscope will add one.

3. Investigate your waveform by moving from search mark to search mark. Use the next (→) or previous (←) arrow button to jump from one marked location to another, without adjusting any other controls.
4. Delete a mark. Push the next (→) or previous (←) arrow button to jump to the mark you want to clear. To remove the current, center-positioned mark, push **Set/Clear**. It works on both manually and automatically created marks.

To automatically set and clear (delete) search marks:

1. Push **Search**.

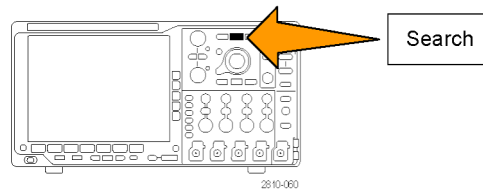

2. Select the search type desired from the lower-bezel menu.

The search menu is similar to the trigger menu.

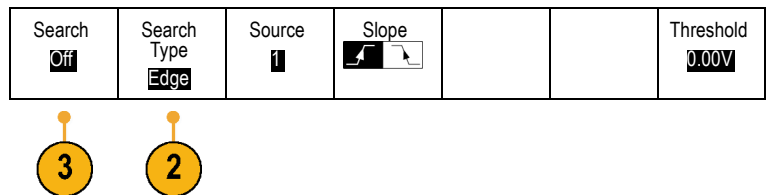

3. From the side-bezel menu, turn on the search.

4. On the screen, hollow triangles show the location of automatic marks and solid triangles show the custom (user-defined) locations. These appear on both normal and zoomed waveform views.
5. You can quickly investigate your waveform by moving from search mark to search mark with the next (→) and previous (←) arrow buttons. No other adjustments are needed.

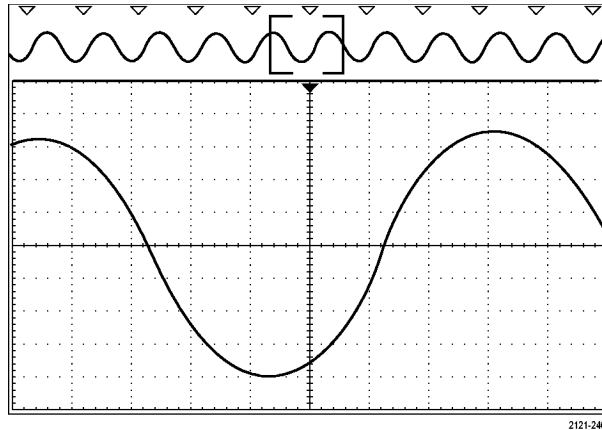

**Quick tips.**

- You can copy trigger settings to search for other locations in your acquired waveform that meet the trigger conditions.
- You can also copy search settings to your trigger.
- Custom (User) marks are saved with the waveform when the waveform is saved and when the setup is saved.
- Automatic search marks are not saved with the waveform when the waveform is saved. However, you can easily recapture them by reusing the search function.
- The search criteria are saved in the saved setup.

The Wave Inspector includes the following search capabilities:

Search	Description
Edge	Searches for edges (rising or falling) with a user-specified threshold level.
Pulse Width	Searches for positive or negative pulse widths that are >, <, =, or ≠ a user specified pulse width, or are inside or outside of a range.
Runt	Searches for positive or negative pulses that cross one amplitude threshold but fail to cross a second threshold before crossing the first again. Search for all runt pulses or only those with a duration >, <, =, or ≠ a user specified time.
Logic	Search for a logic pattern (AND, OR, NAND, or NOR) across multiple waveforms with each input set to either High, Low, or Don't Care. Search for when the event goes true, goes false, or stays valid for >, <, =, or ≠ a user specified time. Additionally, you can define one of the inputs as a clock for synchronous (state) searches.
Setup & Hold	Search for violations of user specified Setup and Hold times.



Search	Description
Rise/Fall Time	Search for rising and/or falling edges that are $>$ , $<$ , $=$ , or $\neq$ a user specified time.
Bus	<p>Parallel: Search for a binary or hex value (MSO4000B Series only).</p> <p>I<sup>2</sup>C: Search for Start, Repeated Start, Stop, Missing Ack, Address, Data, or Address and Data.</p> <p>SPI: Search for SS Active, MOSI, MISO, or MOSI &amp; MISO</p> <p>RS-232, RS-422, RS-485, UART: Search for Tx Start Bit, Rx Start Bit, Tx End of Packet, Rx End of Packet, Tx Data, Rx Data, Tx Parity Error, Rx Parity Error.</p> <p>CAN: Search for Start of Frame, Type of Frame (Data, Remote, Error, Overload), Identifier (standard or extended), Data, Identifier and Data, End of Frame, or Missing Ack, Bit Stuffing Error</p> <p>LIN: Search for Synch, Identifier, Data, ID &amp; Data, Wakeup Frame, Sleep Frame, Error</p> <p>FlexRay: Search for Start of Frame, Type of Frame, Identifier, Cycle Count, Header Fields, Data, ID &amp; Data, End of Frame, Error</p> <p>Audio: Search for Word Select or Data</p> <p>USB: Search for Sync, Reset, Suspend, Resume, End of Packet, Token (Address) Packet, Data Packet, Handshake Packet, Special Packet, or Error</p> <p>Ethernet: Search for Start of Frame, MAC Addresses, MAC Length/Type, MAC Client Data, End of Packet, Idle, FCS (CRC) Error. If Q-(VLAN) Tagging is turned on, you can also search for Q-Tag Control Information.</p> <p>MIL-STD-1553: Search for Sync, Command, Status, Data, Time (RT/IMG), Error</p>

## Limit and Mask Testing

Monitor an active input signal against a mask and output pass or fail results by judging whether the input signal is within the bounds of the mask. To set up and run a limit or mask test, do the following:

1. Select or create the mask.
2. Set up the test.
3. Run the test and view the results.

### Create or Select the Mask

The three mask types you can create or select are: limit test, standard, and custom.

#### Create a limit test mask.

1. Push the front-panel **Default Setup** button.

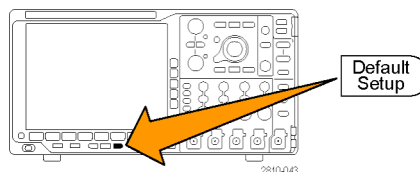

2. Connect your probe from your oscilloscope to the mask source.

3. Push the front-panel **Autoset** button.

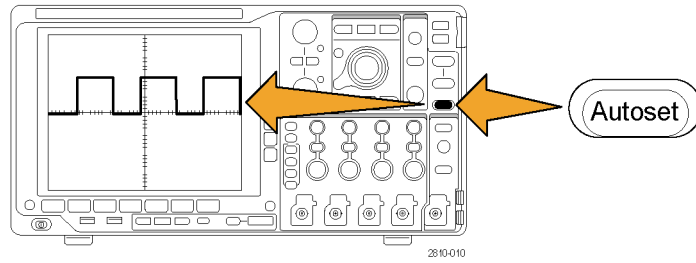

4. Push the front-panel **Test** button.

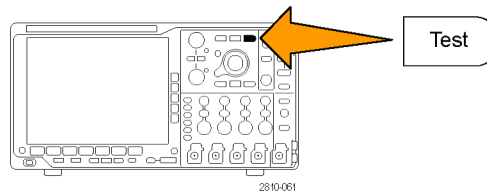

5. Push the lower-bezel menu **Application** item. Turn multipurpose knob **a** to select **Limit/Mask Test** from the menu.
6. Push the lower-bezel menu **Select Mask** item and, from the resulting side menu, select **Limit Test**.
7. Push **Create Limit Mask** from the lower-bezel menu.
8. On the resulting side-bezel menu, push **Source Channel** and turn multipurpose knob **a** to choose the waveform to use as the template for the limit test.
9. Push **Horizontal  $\pm$ Limit** to set the mask horizontal limits. The units are referenced to graticule divisions, where one major division contains 1,000 milli-divisions (mdiv).
10. Push **Vertical  $\pm$ Limit** to set the mask vertical limits. The units are referenced to graticule divisions, where one major division contains 1,000 millidivisions (mdov).
11. Push **OK Create Limit Mask** to make the mask in the oscilloscope.

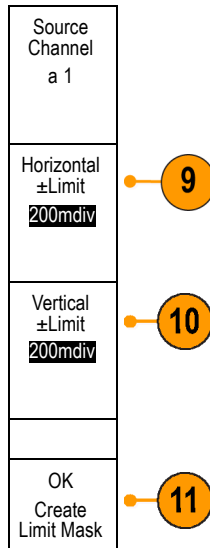

### Select a standard mask.

1. Push the front-panel **Test** button.
2. Push the lower-bezel menu **Application** item. Turn multipurpose knob **a** to select **Limit/Mask Test** from the menu.

3. Push the lower-bezel menu **Select Mask** item and, from the resulting side menu, select **Standard**.
4. Push the lower-bezel **Select Standard**.
5. Use the resulting side menu items to select the desired standard to use.
6. Push **OK Apply Standard** on the side-bezel menu.

**Create a custom mask.** There are three ways to create a custom mask. You can edit a standard mask, load a mask from a text file, or create a mask via a remote interface.

#### **Create a custom mask by editing a standard mask.**

1. Push the front-panel **Test** button.
2. Push the lower-bezel menu **Application** item. Turn multipurpose knob **a** to select **Limit/Mask Test** from the menu.
3. Push the lower-bezel menu **Select Mask** item and, from the resulting side menu, select **Standard**.
4. Push the lower-bezel **Select Standard**.
5. Use the resulting side-bezel menu to select the desired standard to use.
6. Push **OK Apply Standard** on the side-bezel menu.
7. Push the lower-bezel **Set Up Mask**.
8. Push **Copy Active Mask to Custom** from the resulting side-bezel menu.

9. Push **Edit Custom Mask** from the lower-bezel menu.
10. Turn multipurpose knob **a** to adjust the custom mask **Vertical Margin**, as shown in the resulting side-bezel menu. A positive value will spread the upper and lower mask segments apart. A negative value will bring the upper and lower segments together.

---

**NOTE.** For more on editing capabilities, see the “Create a custom mask from a text file” section or the “Create a mask via a remote interface” section.

---

### Create a custom mask from a text file.

1. Push the front-panel **Test** button.
2. Push the lower-bezel menu **Application** item. Turn multipurpose knob **a** to select **Limit/Mask Test** from the menu.
3. Push the lower-bezel **Set Up Mask** item.

- From the resulting side-bezel menu, push **Recall Mask from File**.

Your mask text file should have an ".msk" file name extension and use the following format:

```
:REM "Initialize the custom mask"
:MASK:CUSTOM INIT
:REM "Mask Setup Information"
:MASK:USER:LABEL "Custom Mask of STS-1"
:MASK:USER:AMPLITUDE 1.0000
:MASK:USER:VSCALE 200.0000E-3
:MASK:USER:VPOS -2.5000
:MASK:USER:VOFFSET 0.0E+0
:MASK:USER:HSCALE 4.0000E-9
:MASK:USER:HTRIGPOS 318.1000E-3
:MASK:USER:WIDTH 29.5500E-9
:MASK:USER:RECORDLENGTH 1000
:MASK:USER:TRIGTOSAMP 7.2750E-9
:REM "Mask Points are Defined in Volts and Seconds"
:REM "Points in a segment must be defined in counter clockwise order"
:REM "A single point at 0,0 indicates an empty segment"
:MASK:USER:SEG1:POINTS -7.5000E-9,1.5000,-7.5000E-9,100.0000E-3,-5.1656E-
9,100.0000E-3,-1.3536E-9,500.0000E-3,-1.3536E-9,1.2000,7.2750E-9,1.1000,15.9036E-
9,1.2000,15.9036E-9,500.0000E-3,19.7156E-9,100.0000E-3,22.0500E-9,100.0000E-
3,22.0500E-9,1.5000
:MASK:USER:SEG2:POINTS -7.5000E-9,-500.0000E-3,22.0500E-9,-500.0000E-3,22.0500E-9,-
100.0000E-3,13.4214E-9,-200.0000E-3,13.4214E-9,500.0000E-3,11.6780E-9,800.0000E-
3,7.2750E-9,900.0000E-3,2.8720E-9,800.0000E-3,1.1286E-9,500.0000E-3,1.1286E-9,-
200.0000E-3,-7.5000E-9,-100.0000E-3
:MASK:USER:SEG3:POINTS 0.0E+0,0.0E+0
:MASK:USER:SEG4:POINTS 0.0E+0,0.0E+0
:MASK:USER:SEG5:POINTS 0.0E+0,0.0E+0
:MASK:USER:SEG6:POINTS 0.0E+0,0.0E+0
:MASK:USER:SEG7:POINTS 0.0E+0,0.0E+0
:MASK:USER:SEG8:POINTS 0.0E+0,0.0E+0
```

**Create a custom mask via a remote interface.** To use remote interface commands to create and edit a mask, see the MSO4000B and DPO4000B Series Oscilloscope Programmer Manual.

## Set Up the Test

To set up the limit or mask test, connect the test source to the oscilloscope. For a limit test, set the test source horizontal and vertical settings to the same values that were used to create the limit test mask. Push the lower-bezel menu **Set Up Test** item and set the following:

Setting	Description
Source Channel	Select the channel to be tested
Violation Threshold	Set the number of violations that can occur before a test status is considered failed.
Stop After Waveform	Set the test to stop after a set number of waveforms.
Stop After Time	Set the test to stop after a set amount of time elapses.

Setting	Description
Select Action on Failure	Set how the oscilloscope responds to test failure. You can set multiple actions. These are: Stop acquisition Save waveform to file Save screen image to file Print screen image Aux out pulse Set a remote interface service request (SRQ)
Select Action on Test Completion	Set how the oscilloscope will respond to test completion. You can set multiple actions. They are: Aux out pulse Set a remote interface service request (SRQ)
Pre-Test Delay	Set a delay before starting a test.
Repeat Test	Set <b>On</b> for the test to repeat when it has run the minimum number of waveforms or the minimum amount of time.  Set <b>Off</b> for the test to run a single time and not repeat.
Mask Polarity	Set the mask polarity to use during the test. When <b>Both</b> is selected, the test will run with <b>Normal</b> polarity for about half of the expected number of waveforms or amount of time and then will run with <b>Inverted</b> polarity for the remained of the test.

### Run the Test and View the Results

1. Push the lower-bezel **Run Test** item to start and stop the test.
2. Push the lower-bezel **Show Results** item and use the resulting side menu to select whether to show basic or more detailed results. You can also reset the results.

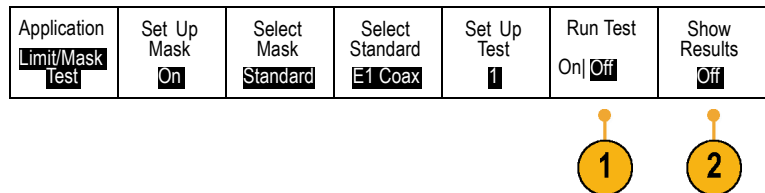

### Quick Tips

- Use Average acquisition mode to create a smoother, cleaner limit test mask.
- If you want to re-use the mask later, save it to a file by selecting **Set Up Mask** from the lower menu and **Save Mask to File** from the resulting side-bezel menu.
- To simplify the setup of the test source, save the oscilloscope setup so that later you can quickly reload the settings to correctly display the test source for limit testing.
- Have the mask automatically re-scale with the source channel setting changes by selecting **Set Up Mask** from the lower menu and **Lock to Source** as **On** with the resulting side-bezel menu.
- The math waveform is not available when using mask testing.

## Analyzing Power

Acquire, measure, and analyze power signals with the DPO4PWR Power Analysis Module. To use this application:

1. Push **Test**.

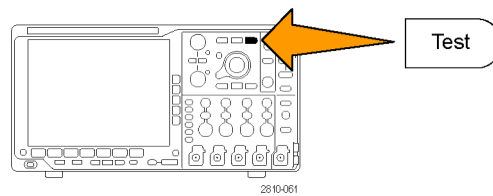

2. Turn multipurpose knob **a** to select **Power Analysis**.

3. Push **Analysis**.

Applica- tion	Analysis None					
------------------	------------------	--	--	--	--	--



4. Use the side-bezel buttons to select the desired analysis function.

Choose among power quality, switching loss, harmonics, ripple, modulation, and safe operating area, and deskew. See the *DPO3PWR and DPO4PWR Power Analysis Modules User Manual* for more information.

## Save and Recall Information

The oscilloscope provides permanent storage for setups, waveforms, and screen images. Use the internal storage of the oscilloscope to save setup files and reference waveform data.

Use external storage, such as USB flash drives or network drives, to save setups, waveforms, and screen images. Use the external storage to carry data to remote computers for further analysis and for archiving.

**External file structure.** If you are saving information to external storage, select the appropriate menu (such as the **To File** side-bezel menu to save setups and waveforms) and turn multipurpose knob **a** to scroll through the external file structure.

- E: is the USB memory device plugged into the first (left) USB port on the front of the oscilloscope
- F: is the USB memory device plugged into the second (right) USB port on the front of the oscilloscope
- G: and H: are the USB memory devices plugged into the USB ports on the rear of the oscilloscope
- I through Z are network storage locations

Use multipurpose knob **a** to scroll through the list of files. Use the **Select** front panel button to open and close folders.

### Naming your file.

The oscilloscope gives all files it creates a default name in the following format:

- tekXXXXX.set for setup files where XXXXX is an integer from 00000 to 99999
- tekXXXXX.png, tekXXXXX.bmp, or tekXXXXX.tif for image files
- tekXXXXYYY.csv for spreadsheet files or tekXXXXYYY.isf for internal format files

For waveforms, the XXXX is an integer from 0000 to 9999. The YYY is the channel of the waveform, and can be one of the following:

- CH1, CH2, CH3, or CH4 for the analog channels
- D00, D01, D02, D03, and so on through D15 for the digital channels
- MTH for a math waveform
- RF1, RF2, RF3, or RF4 for reference memory waveforms
- ALL for a single spreadsheet file containing multiple channels when you select Save All Waveforms

---

**NOTE.** Only analog channels and waveforms derived from analog channels (such as math and reference) can be saved to an ISF file. When saving all channels in ISF format, a group of files will be saved. Each will have the same value for XXXX, but the YYY values will be set to the different channels that were turned on when the Save All Waveforms was performed.

---

For example, the first time you save a file, that file is named tek00000. The next time you save the same type of file, the file will be named tek00001.



**Editing file, directory, reference waveform, or instrument setup names.** Give files descriptive names that you can recognize at a later date. To edit file names, directory names, reference waveform and instrument setup labels:

1. Push **Save / Recall Menu**.

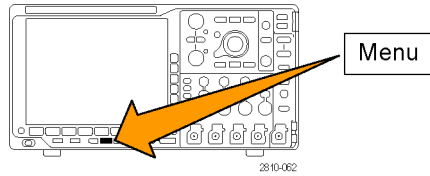

2. Push **Save Screen Image, Save Waveform, or Save Setup**.

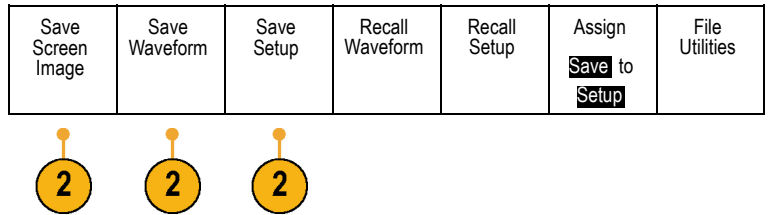

3. For waveform or setup files, enter the file manager by pushing the appropriate side-bezel menu item.

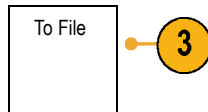

4. Turn multipurpose knob **a** to scroll through the file structure. (See page 134, *External file structure*.)

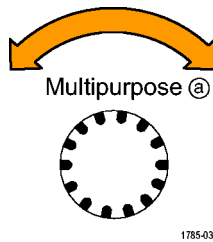

5. Push **Select** to open or close file folders.

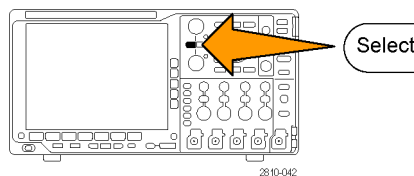

6. Push **Edit File Name**.

Edit the file name the same way you edit labels for channels. (See page 45, *Labeling Channels and Buses*.)

7. Push the **Menu Off** button to cancel the save operation, or push a side-bezel menu **OK Save** item to complete the operation.

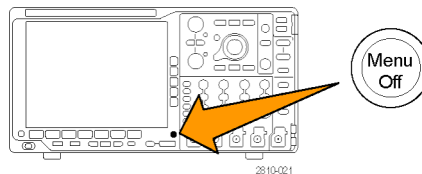



## Saving a Screen Image

A screen image consists of a graphical image of the oscilloscope screen. This is different from waveform data, which consists of numeric values for each point in the waveform. To save a screen image:

1. Push **Save / Recall Menu**.  
Do not yet push the **Save** button.

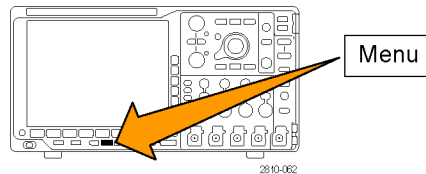

2. Push **Save Screen Image** from the lower-bezel menu.

Save Screen Image	Save Waveform	Save Setup	Recall Waveform	Recall Setup	Assign <b>Save to Setup</b>	File Utilities
-------------------	---------------	------------	-----------------	--------------	-----------------------------	----------------



3. From the side-bezel menu, push **File Format** repeatedly to select among: .tif, .bmp, and .png formats.
4. Push **Orientation** to select between saving the image in a landscape (horizontal) and a portrait (vertical) orientation.
5. Push **Ink Saver** to turn the **Ink Saver** mode on or off. When on, this mode provides a white background.
6. Push **Edit File Name** to create a custom name for the screen image file. Skip this step to use a default name.
7. Push **OK Save Screen Image** to write the image to the selected media.

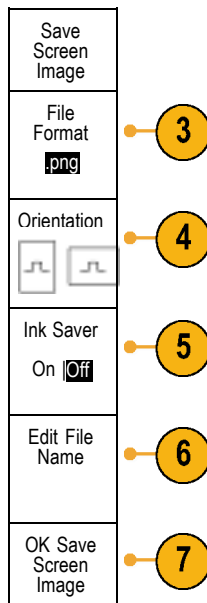

For information on printing screen images of waveforms, go to *Printing a Hard Copy*. (See page 143, *Printing a Hard Copy*.)

## Saving and Recalling Waveform Data

Waveform data consists of the numeric values for each point in the waveform. It copies the data, as opposed to a graphical image of the screen. To save the current waveform data or to recall previously stored waveform data:

1. Push **Save / Recall Menu**.

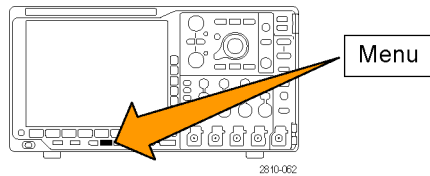

2. Push **Save Waveform** or **Recall Waveform** from the lower-bezel menu.

Save Screen Image	Save Waveform	Save Setup	Recall Waveform	Recall Setup	Assign <b>Save to Waveform</b>	File Utilities
-------------------	---------------	------------	-----------------	--------------	--------------------------------	----------------



**NOTE.** The oscilloscope can save digital waveforms to .csv files, not reference memories. The oscilloscope cannot recall digital waveforms.

3. Select one waveform or all waveforms.
4. From the resulting side-bezel menu, select the location to save the waveform data to or to recall it from.  
 Save the information externally to a file on a USB flash drive or mounted network drive. Alternatively, save the information internally to one of the four reference files.

5. Push **File Details** to save to a USB or network drive.



This brings up the file manager screen. Use it to navigate to the desired drive and folder, and optionally to specify the file name. Skip this step to use the default name and location.

**Saving a waveform to file.** When you push the **File Details** side-bezel menu button, the oscilloscope changes the side-bezel menu contents. The following table describes these side-bezel menu items for saving data to a mass storage file.

Side-bezel menu button	Description
Internal File Format (.ISF)	Sets the oscilloscope to save waveform data from analog channels (and math and reference waveforms derived from analog channels), in internal waveform save file (.isf) format. This format is the fastest to write and creates the smallest-sized file. Use this format if you intend to recall a waveform to reference memory for viewing or measuring. The oscilloscope cannot save digital waveforms in an .isf file format.
Spreadsheet file format (.csv)	Sets the oscilloscope to save waveform data as a comma-separated data file compatible with popular spreadsheet programs. This file can also be recalled to reference memory.

**Saving an analog waveform to reference memory.** To save an analog waveform to nonvolatile memory inside the oscilloscope, push the **Save Waveform** screen button, select the waveform that you want to save, and then select one of the four reference waveform locations.

Saved waveforms contain only the most recent acquisition. Gray-scale information, if any, is not saved.

---

**NOTE.** 5M, 10 M and 20 M reference waveforms are volatile and not saved when the oscilloscope power is turned off. To keep these waveforms, save them to external storage.

---

**Displaying a reference waveform.** To display a waveform stored in nonvolatile memory:

1. Push **Ref R**.

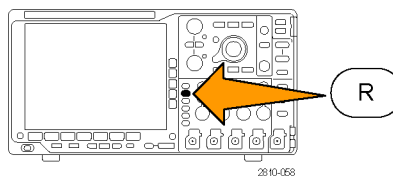

2. Push **R1**, **R2**, **R3**, or **R4**.

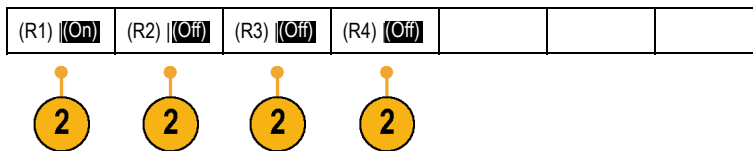

**Removing a reference waveform from the display.** To remove a reference waveform from the display:

1. Push **Ref R**.

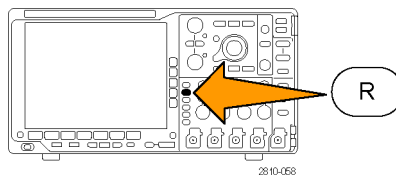

2. Push the **R1**, **R2**, **R3**, or **R4** lower-bezel button to remove the reference waveform from the display.

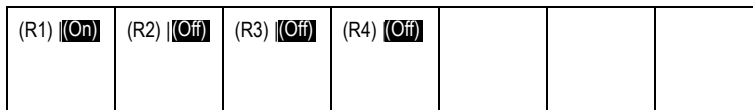

The reference waveform is still in nonvolatile memory and can be displayed again.

## Saving and Recalling Setups

Setup information includes acquisition information, such as vertical, horizontal, trigger, cursor, and measurement information. It does not include communications information, such as GPIB addresses. To save the setup information:

1. Push **Save / Recall Menu**.

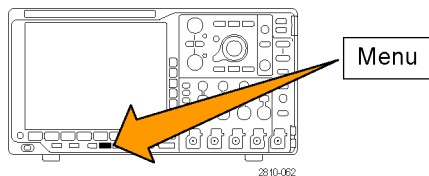

2. Push **Save Setup** or **Recall Setup** from the lower-bezel menu.

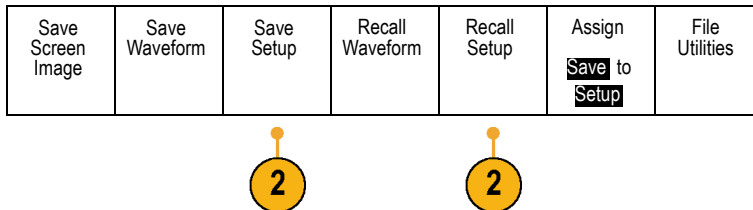

- From the resulting side-bezel menu, select the location to save the setup to or to recall it from.

To save setup information to one of the ten internal setup memories in the oscilloscope, push the appropriate side-bezel button.

To save setup information to a USB or network drive, push the **To File** button.

Save Setup	
To File	3
Edit Labels	
To Setup 1	3
To Setup 2	
- more -	

- If you are saving information to a USB or network drive, turn multipurpose knob **a** to scroll through the file structure. (See page 134, *External file structure*.)

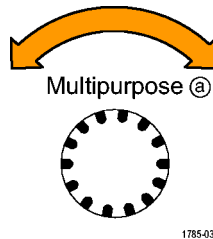

Push **Select** to open or close file folders.

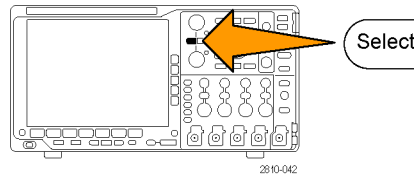

Push the **Menu Off** button to cancel the save operation, or push a side-bezel menu **Save to Selected File** item to complete the operation.

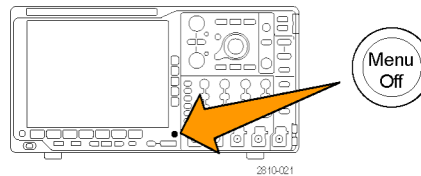

5. Save the file.

Save to Selected File

### Quick Tips

- **Recalling the Default Setup.** Push the front-panel **Default Setup** button to initialize the oscilloscope to a known setup. (See page 47, *Using the Default Setup.*)

## Saving with One Button Push

After you have defined the save/recall parameters with the Save/Recall Menu button and menu, you can save files with a single push of the **Save** button. For example, if you have defined the save operation to save waveform data to a USB flash drive, then each push of the **Save** button will save current waveform data to the defined USB flash drive.

1. To define the Save button behavior, push **Save/Recall Menu**.

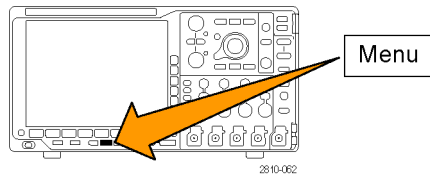

2. Push **Assign Save to ....**

Save Screen Image	Save Waveform	Save Setup	Recall Waveform	Recall Setup	Assign <b>Save to Setup</b>	File Utilities
-------------------	---------------	------------	-----------------	--------------	-----------------------------	----------------

2

3. Push the side-button corresponding to the items or items you wish to save when you push the **Save** button.

Assign Save to
<b>Screen Image</b>
Waveform
Setup
Image, Waveform, and Setup

- From now on, when you push **Save** the oscilloscope will perform the action that you just specified rather than requiring you to navigate through the menus each time.

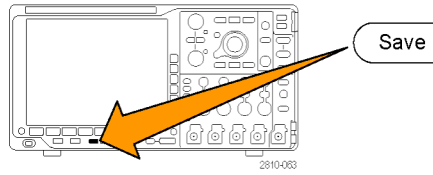

## Managing Drives, Directories, and Files

You can manage drives, directories, and files from the oscilloscope user interface.

- Push **Save/Recall Menu**.

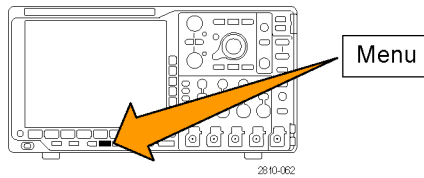

- Push **File Utilities**.

Save Screen Image	Save Waveform	Save Setup	Recall Waveform	Recall Setup	Assign Save to Setup	File Utilities
-------------------	---------------	------------	-----------------	--------------	----------------------	----------------

Select the desired file operation from the side menus. You can:

- Create a new folder
- Delete a highlighted directory, or file
- Copy a highlighted drive, directory or file
- Paste a previously copied drive, directory, or file
- Mount or unmount a networked drive
- Rename a highlighted drive, directory, or file
- Format a highlighted drive



## Mounting a Network Drive

Mount a network storage device, such as a PC or a file server, to save setups, waveforms, and screen images directly to the drive or to recall waveforms or setups from the drive.

To save to or recall files from a network drive, you must first connect your oscilloscope to the network (See page 23, *Connecting Your Oscilloscope to a Computer*).

---

**NOTE.** Consult your network administrator for information related to your network.

---



After the network connection has been established, do the following:

1. Push the front-panel Save/Recall Menu button.
2. Push the bottom-bezel **File Utilities** item and, from the resulting side menu, select **– more – 1 of 2**. Then select **Mount**.
3. From the resulting side menu, set the following:

Setting	Description
Drive Letter	Select from I: to Z:
Server Name or IP Address	Use a USB keyboard or the on-screen interface to enter the server name or IP address.
Path	Use a USB keyboard or the on-screen interface to enter the shared file path. For example, to mount an MS Windows PC directory named "C:\Example", enter "C\$\Example". The dollar sign enables sharing. No colon is needed.
User Name	If necessary, use a USB keyboard or the on-screen interface to enter the user name.
User Password	If necessary, use a USB keyboard or the on-screen interface to enter the user password. The oscilloscope only displays "*"s as you type the password. They are erased from the screen after <b>OK Accept</b> is pushed.

---

**NOTE.** Ensure that file sharing is enabled for the network location.

---

4. Push **OK Accept**.

---

**NOTE.** To unmount a network drive, push the front panel Save/Recall **Menu** button, the lower-bezel menu **File Utilities**, the side-menu **– more – 1 of 2**, and **Unmount** items.

---



---

**NOTE.** Any network locations that were mounted when the oscilloscope was powered down will be automatically remounted when the oscilloscope is powered up. Unmount any network location that you do not want to automatically remount on power up.

---

## Printing a Hard Copy

To print an image of what appears on the oscilloscope screen, do the following procedure.

### Connect a Printer to Your Oscilloscope

Connect a non-PictBridge printer to a USB port on the rear or front panel of the oscilloscope. Alternatively, connect a PictBridge printer to the USB device port on the rear panel, or hook up a networked printer through the Ethernet port.

---

**NOTE.** Refer to the [www.tektronix.com/printer\\_setup](http://www.tektronix.com/printer_setup) Web page for a list of compatible printers.

---

## Set Up Print Parameters

To set up the oscilloscope to print hard copies:

1. Push **Utility**.

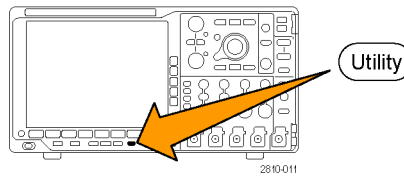

2. Push **Utility Page**.



3. Turn multipurpose knob **a** and select **Print Setup**.



4. Push **Select Printer** if you are changing the default printer.



Turn multipurpose knob **a** to scroll through the list of available printers.

Push **Select** to choose the desired printer.

To add a non-PictBridge USB printer to the list, plug the printer into a USB host port. The oscilloscope will automatically recognize most printers.

To set up a PictBridge USB printer, refer to the next topic.

To add an Ethernet printer to the list, refer to that topic. (See page 146, *Printing Over Ethernet*.)

5. Select the image orientation (portrait or landscape).

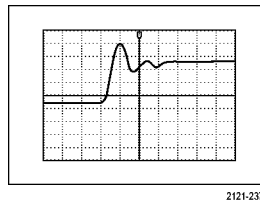

Landscape

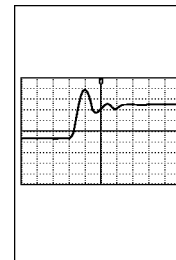

Portrait

- Choose **Ink Saver On** or **Off**.  
The **On** selection will print out a copy with a clear (white) background.

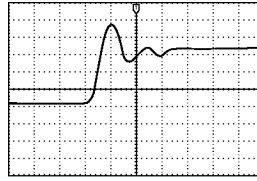

Ink Saver on

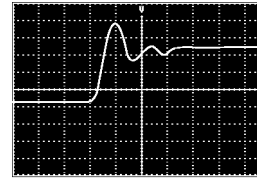

Ink Saver off

## Printing to a PictBridge Printer

To set up the oscilloscope to print to a PictBridge printer:

- Push **Utility**.

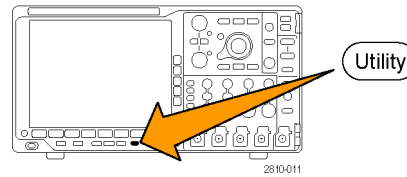

- Push **Utility Page**.



- Turn multipurpose knob **a** and select **I/O**.



- Push **USB**.

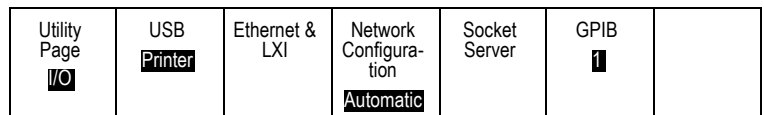

- 5. Push **Connect to PictBridge Printer**.

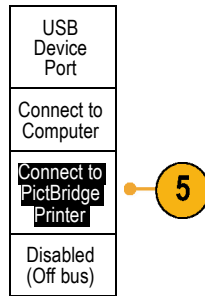

### Printing Over Ethernet

To set up the oscilloscope to print over Ethernet:

- 1. Connect an Ethernet cable to the rear-panel Ethernet port.

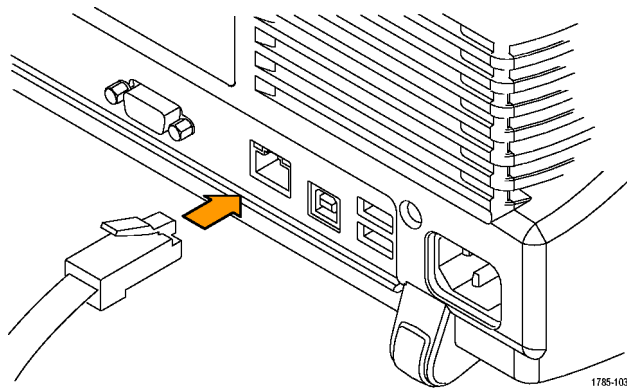

- 2. Push **Utility**.

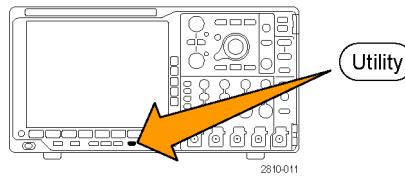

- 3. Push **Utility Page**.



- 4. Turn multipurpose knob **a** and select **Print Setup**.



5. Push **Select Printer**.

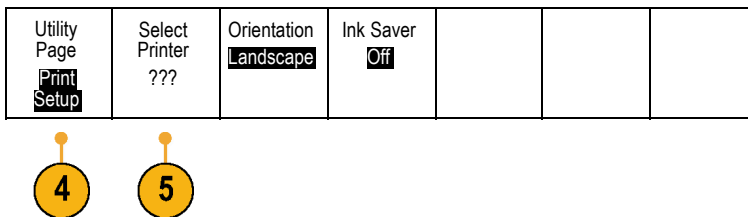

6. Push **Add Network Printer**.

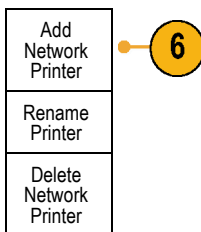

7. Turn multipurpose knob **a** to scroll through the list of letters, numbers, and other characters to find the first character in the printer name that you want to enter.

If you are using a USB keyboard, use the arrow keys to position the insertion point and type in the printer name. (See page 27, *Connecting a USB Keyboard to Your Oscilloscope.*)



Multipurpose @



1785-038

ABCDEFGHIJKLMNOPQRSTUVWXYZ  
 abcdefghijklmnopqrstuvwxyz  
 0123456789\_+!@#\$%^&\*(){}<>/~`|:;.,?`

8. Push **Select** or **Enter Character** to let the oscilloscope know that you have picked the proper character to use.

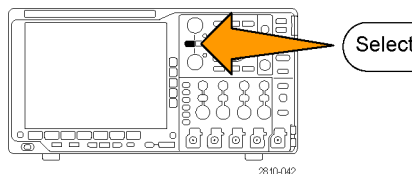

You can use the lower-bezel buttons to edit the name, as needed.

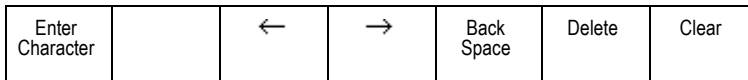

9. Continue scrolling and pushing **Select** until you have entered all the desired characters.

10. Push the down arrow key to move the character cursor down a row to the **Server Name** field.
11. Turn multipurpose knob **a** and push **Select** or **Enter Character** as often as needed to enter the name.
12. If desired, push the down arrow key to move the character cursor down a row to the **Server IP Address:** field.

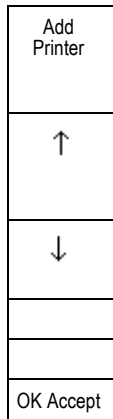

13. Turn multipurpose knob **a** and push **Select** or **Enter Character** as often as needed to enter the name.
14. When done, push **OK Accept**.

---

**NOTE.** *If you have multiple printers connected to the oscilloscope at the same time, the oscilloscope will print to the printer listed in the Utility> Utility Page> Print Setup> Select Printer menu item.*

---

### Printing with One Button Push

Once you have connected a printer to your oscilloscope and set up print parameters, you can print current screen images with a single push of a button:

Push the printer icon button in the lower left corner of the front panel.

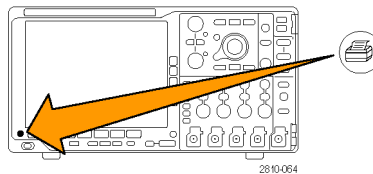

## Erasing Oscilloscope Memory

You can erase all setup and waveform information saved in the nonvolatile oscilloscope memory with the TekSecure function. If you have acquired confidential data on your oscilloscope, you may want to execute the TekSecure function before you return the oscilloscope to general use. The TekSecure function:

- Replaces all waveforms in all reference memories with null values
- Replaces the current front-panel setup and all stored setups with the default setup
- Displays a confirmation or warning message, depending on whether the verification is successful or unsuccessful

To use TekSecure:

1. Push **Utility**.

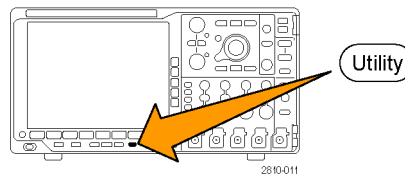

2. Push **Utility Page**.



3. Turn multipurpose knob **a** and select **Config**.

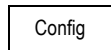

4. Push **TekSecure Erase Memory**.

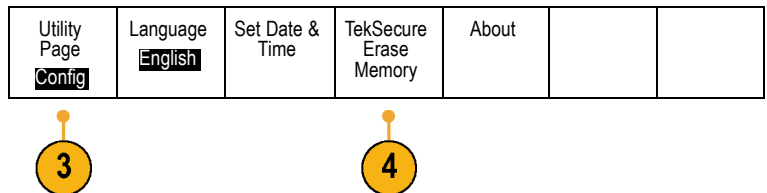

5. Push **OK Erase Setup and Ref Memory** from the side-bezel menu.

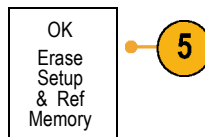

To cancel the procedure, push **Menu Off**.

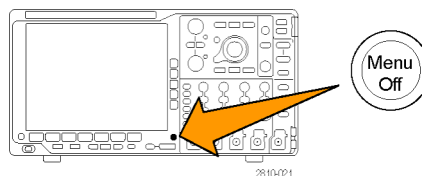

6. Power off the oscilloscope, and then power it back on to complete the process.

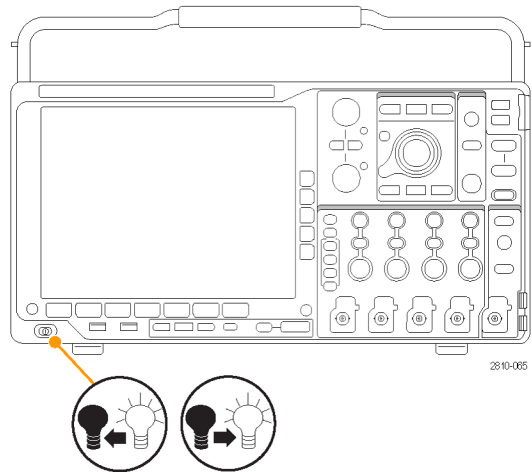



## Using Application Modules

Optional application module packages extend the capability of your oscilloscope. (See page 15, *Application Module Free Trial*.) (See page 15, *Installing an Application Module*.)

Refer to the *MDO4000, MSO4000, MSO4000B, DPO4000, and DPO4000B Series Application Model Installation Instructions* that came with your application module for instructions on installing and testing an application module. Some modules are described in the following list. Additional modules may be available. Contact your Tektronix representative or visit our Web site at [www.tektronix.com](http://www.tektronix.com) for more information. Also, refer to *Contacting Tektronix* at the beginning of the manual.

- The **DPO4AERO Aerospace Serial Triggering and Analysis Module** adds triggering and analysis on MIL-STD-1553 buses.
- The **DPO4AUDIO Audio Serial Triggering and Analysis Module** adds triggering and analysis on I<sup>2</sup>S, Left Justified (LJ), Right Justified (RJ), and TDM buses, as well as analytical tools to help you efficiently analyze your serial bus. These include digital views of the signal, bus views, packet decoding, search tools, and event tables with timestamp information.
- The **DPO4AUTO Automotive Serial Triggering and Analysis Module** adds triggering and analysis on packet level information in serial buses used in automotive designs (CAN and LIN), as well as analytical tools to help you efficiently analyze your serial bus. These include digital views of the signal, bus views, packet decoding, search tools, and event tables with timestamp information.
- The **DPO4AUTOMAX FlexRay, CAN, and LIN Serial Triggering and Analysis Module** offers the features of the DPO4AUTO Module plus FlexRay serial bus support, as well as analytical tools to help you efficiently analyze your serial bus. These include digital views of the signal, bus views, packet decoding, search tools, and event tables with timestamp information.
- The **DPO4COMP Computer Serial Triggering and Analysis Module** adds triggering and analysis on byte or packet level information in RS-232, RS-422, RS-485, and UART buses, and analytical tools to help you efficiently analyze your serial bus. These include digital views of the signal, bus views, packet decoding, search tools, and event tables with timestamp information.
- The **DPO4EMBD Embedded Serial Triggering and Analysis Module** adds triggering and analysis on packet level information in serial buses used in embedded designs (I<sup>2</sup>C and SPI), as well as analytical tools to help you efficiently analyze your serial bus. These include digital views of the signal, bus views, packet decoding, search tools, and event tables with timestamp information.
- The **DPO4ENET Serial Triggering and Analysis Module** adds triggering and analysis on 10BASE-T and 100BASE-TX bus signals, as well as analytical tools to help you efficiently analyze your serial bus. These include digital views of the signal, bus views, packet decoding, search tools, and event tables with timestamp information.
- The **DPO4LMT Limit and Mask Test Module** adds testing acquired waveforms against a comparison waveform with user-defined horizontal and vertical limits or against telecom standard masks or custom masks.
- The **DPO4PWR Power Analysis Module** adds measurements of power quality, switching loss, harmonics, ripple, modulation, safe operating area, and slew rate (dV/dt and dI/dt).
- The **DPO4USB USB 2.0 Serial Triggering and Analysis Module** adds triggering and analysis on USB low-speed, full-speed, and high-speed buses.
- The **DPO4VID Extended Video Module** adds triggering on a variety of standard HDTV signals, as well as on custom (non-standard) bilevel and trilevel video signals with 3 to 4,000 lines.

## Application Examples

This section contains ways to use your instrument in both common and advanced troubleshooting tasks.

### Taking Simple Measurements

If you need to see a signal in a circuit, but you do not know the signal amplitude or frequency, connect the probe from channel 1 of the oscilloscope to the signal. Then display the signal and measure its frequency and peak-to-peak amplitude.

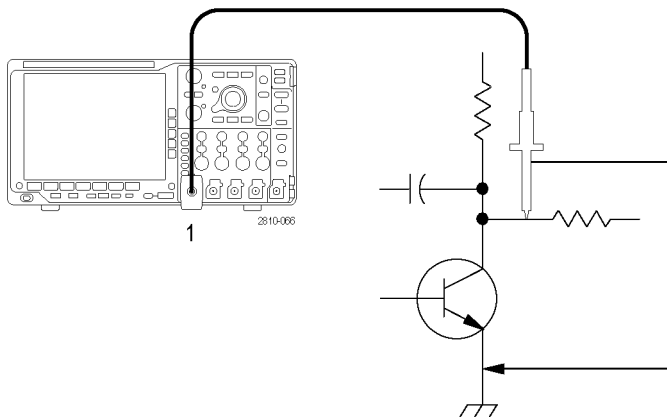

### Using Autoset

To quickly display a signal:

1. Push **Autoset**.

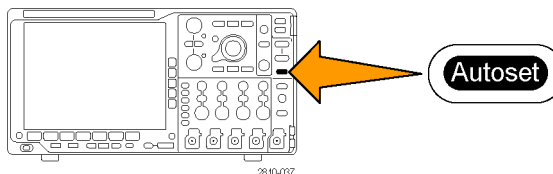

The oscilloscope sets vertical, horizontal, and trigger controls automatically. You can manually adjust any of these controls if you need to optimize the display of the waveform.

When you are using more than one channel, the autoset function sets the vertical controls for each channel and uses the lowest-numbered active channel to set the horizontal and trigger controls.

## Selecting Automatic Measurements

The oscilloscope can take automatic measurements of most displayed signals. To measure signal frequency and peak-to-peak amplitude:

1. Push **Measure**.

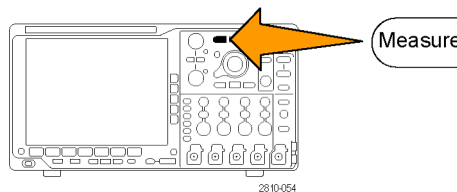

2. Push **Add Measurement**.

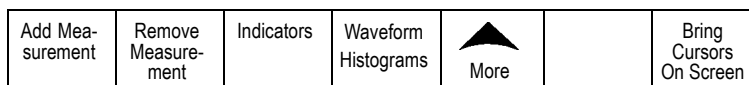

3. If needed, from the side menu, push **Source** and turn multipurpose knob **a** to select the channel from which you want to measure. Turn multipurpose knob **b** to select the **Frequency** measurement. Push **OK Add Measurement** from the side menu. Repeat this process to select another channel, the **Peak-to-peak** measurement, and again pushing **OK Add Measurement**.

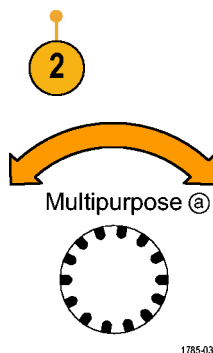

4. Push **Menu Off**.

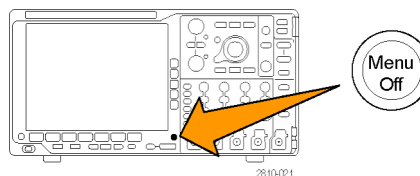

- Observe that the measurements appear on the screen and update as the signal changes.

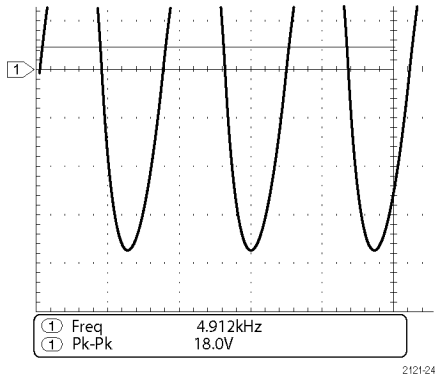

### Measuring Two Signals

In this example, you are testing a piece of equipment and need to measure the gain of its audio amplifier. You have an audio generator that can inject a test signal at the amplifier input. Connect two oscilloscope channels to the amplifier input and output as shown. Measure both signal levels and use these measurements to calculate the gain.

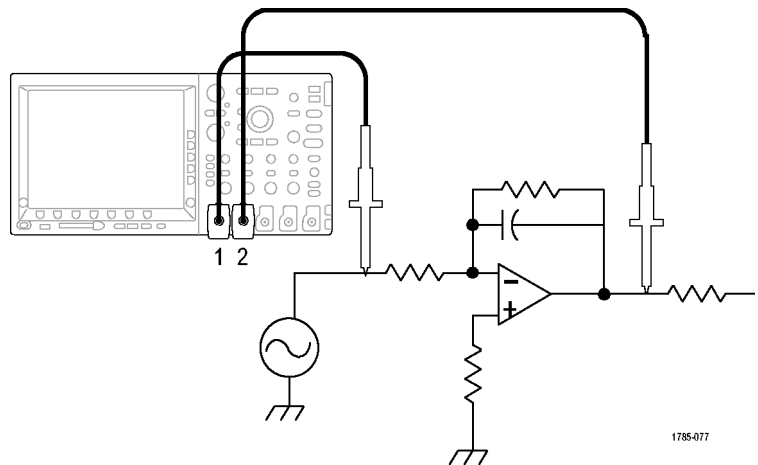

To display the signals connected to channels 1 and 2:

- Push channel 1 and channel 2 to activate both channels.

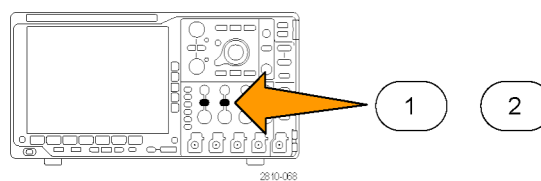

2. Push **Autoset**.

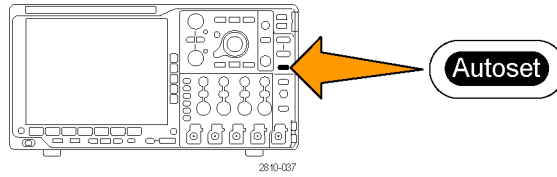

To select measurements for the two channels:

1. Push **Measure** to see the measurement menu.

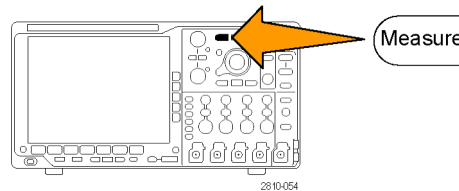

2. Push **Add Measurement**.

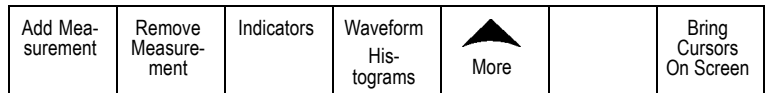

3. If needed, from the side menu, push **Source** and turn multipurpose knob **a** to select channel 1. Turn multipurpose knob **b** to select the **Amplitude** measurement. Push **OK Add Measurement** from the side menu. Repeat this process to select channel 2 and again push **OK Add Measurement**.

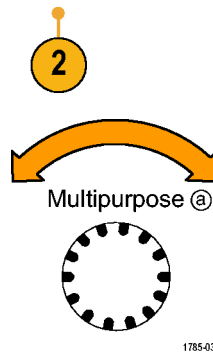

- Calculate the amplifier gain using the following equations:  
 $Gain = (output\ amplitude \div input\ amplitude)$   
 $= (3.155\ V \div 130.0\ mV) = 24.27$   
 $Gain\ (dB) = 20 \times \log(24.27) = 27.7\ dB$

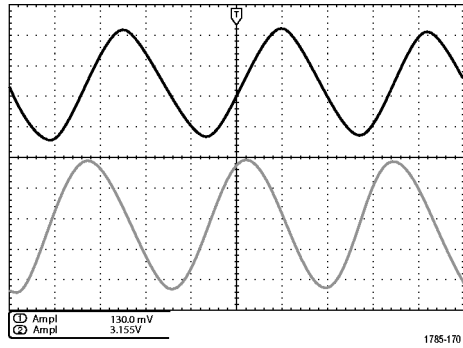

### Customizing Your Measurements

In this example, you want to verify that the incoming signal to digital equipment meets its specifications. Specifically, the transition time from a low logic level (0.8 V) to a high logic level (2.0 V) must be 10 ns or less.

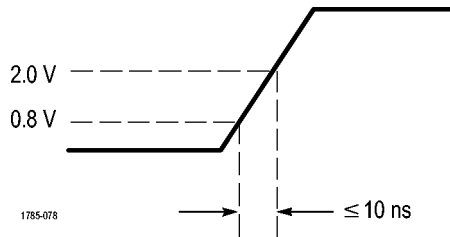

To select the Rise Time measurement:

- Push **Measure**.

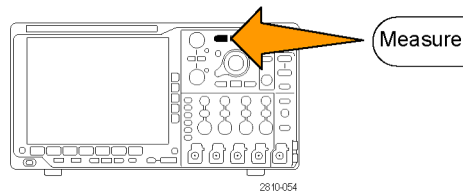

- Push **Add Measurement**.

Add Measurement	Remove Measurement	Indicators	Waveform Histograms	More	Bring Cursors On Screen
-----------------	--------------------	------------	---------------------	------	-------------------------



- If needed, from the side menu, push **Source** and turn multipurpose knob **a** to select the channel from which you want to measure. Turn multipurpose knob **b** to select the **Rise Time** measurement. Push **OK Add Measurement** from the side menu.

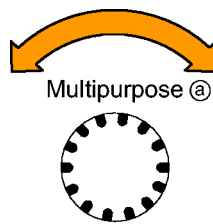

4. Push **More** repeatedly until you select **Reference Levels** from the popup menu.

5. Push **Set Levels in** to select **units**.

6. Push **High Ref** and turn multipurpose knob **a** to enter 2.00 V. If needed, push **Fine** to change the sensitivity of the multipurpose knob.

7. Push **Low Ref** and turn multipurpose knob **a** to enter 800 mV. If needed, push **Fine** to change the sensitivity of the multipurpose knob.

Reference Levels
Set Levels in %   <b>Units</b>
High Ref <b>(a) 2.00 V</b>
Mid Ref
Low Ref <b>(a) 800 mV</b>

Rise time is typically measured between the 10% and 90% amplitude levels of a signal. These are the default reference levels that the oscilloscope uses for rise time measurements. However, in this example, you need to measure the time that the signal takes to pass between the 0.8 V and 2.0 V levels.

You can customize the rise time measurement to measure the signal transition time between any two reference levels. You can set each of these reference levels to a specific percent of the signal amplitude or to a specific level in vertical units (such as volts or amperes).

**Measuring specific events.** Next you want to see the pulses in the incoming digital signal, but the pulse widths vary so it is hard to establish a stable trigger. To look at a snapshot of the digital signal, do this step:

1. Push **Single** to capture a single acquisition. This assumes that the oscilloscope will trigger with the current settings.

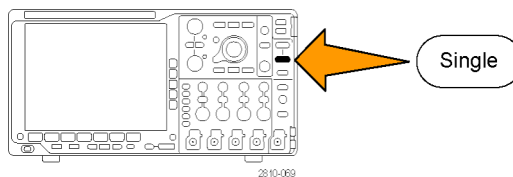

Now you want to measure the width of each displayed pulse. You can use measurement gating to select a specific pulse to measure. To measure the second pulse:

2. Push **Measure**.

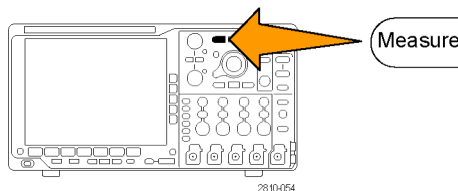

3. Push **Add Measurement**.

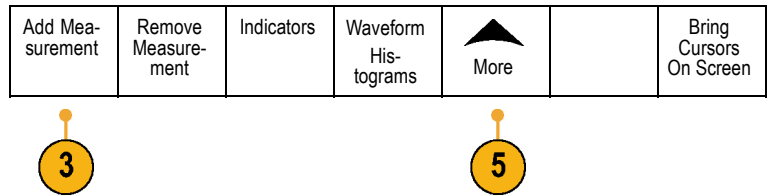

4. If needed, from the side menu, push **Source** and turn multipurpose knob **a** to select the channel from which you want to measure. Turn multipurpose knob **b** to select the **Positive Pulse Width** measurement. Push **OK Add Measurement** from the side menu.

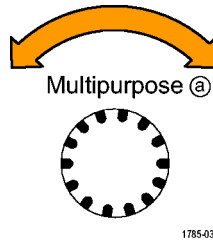

5. Push **More** repeatedly until you select **Gating** from the popup menu.

6. Select **Between Cursors** from the side-bezel menu to choose measurement gating using cursors.

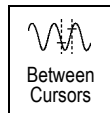

7. Place one cursor to the left and one cursor to the right of the second pulse.
8. View the resulting width measurement (160 ms) for the second pulse.

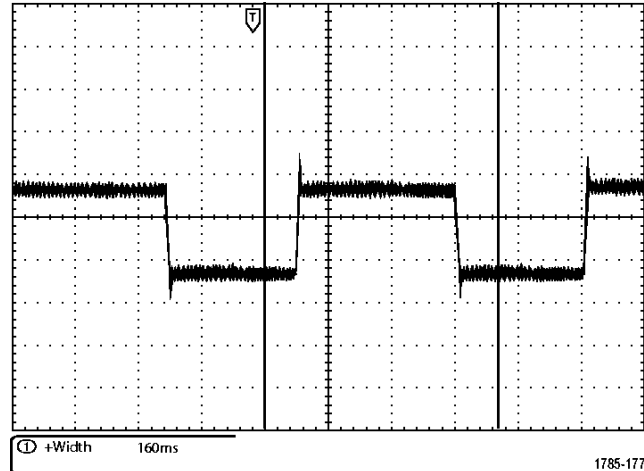



## Analyzing Signal Detail

In this example, you have a noisy signal displayed on the oscilloscope, and you need to know more about it. You suspect that the signal contains much more detail than you can currently see in the display.

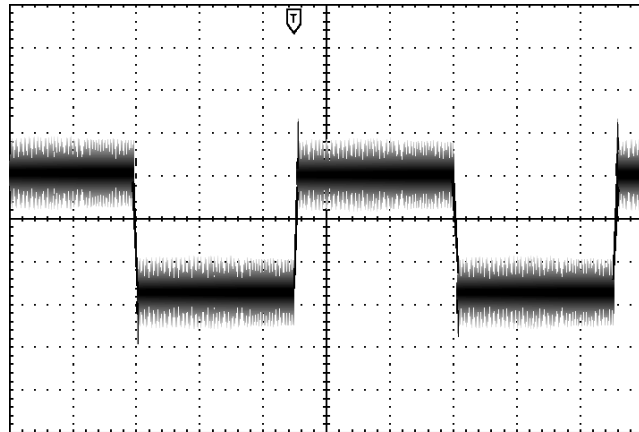

1785-175

## Looking at a Noisy Signal

The signal appears noisy. You suspect that noise is causing problems in your circuit. To better analyze the noise:

1. Push **Acquire**.

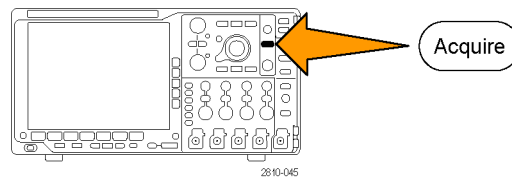

2. Push **Mode** on the lower-bezel menu.

Mode Sample	Record Length 10k	Delay On Off	Set Horiz. Position to 10%	Waveform Display	XY Display Off	
----------------	----------------------	-----------------	----------------------------------	---------------------	-------------------	--



3. Push **Peak Detect** on the side-bezel menu.

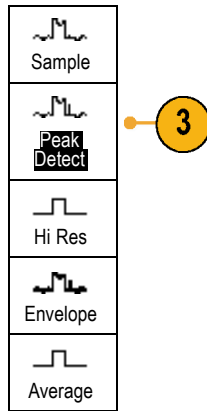

4. Push **Intensity** and turn multipurpose knob **a** to see the noise more easily.

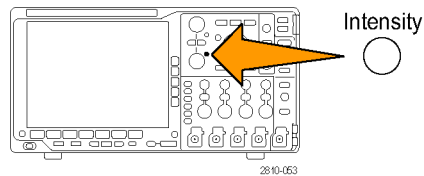

5. View the results on the display. Peak detect emphasizes noise spikes and glitches in your signal as narrow as 1 ns, even when the time base is set to a slow setting.

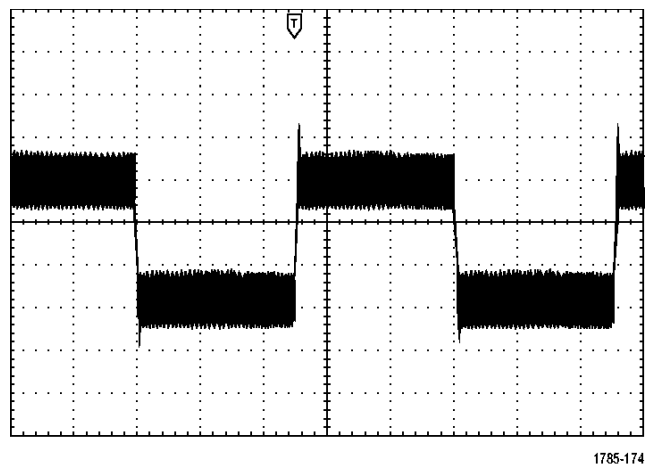

Peak-detect and the other acquisition modes are explained earlier in this manual. (See page 49, *Acquisition Concepts*.)

### Separating the Signal from Noise

Now you want to analyze the signal shape and ignore the noise. To reduce random noise in the oscilloscope display:

1. Push **Acquire**.

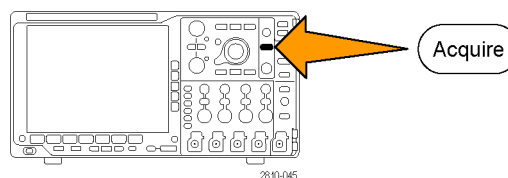

2. Push **Mode**.

Mode Sample	Record Length 10K	Delay On Off	Set Horiz. Position to 10%	Waveform Display	XY Display Off	
----------------	----------------------	-----------------	-------------------------------	------------------	-------------------	--



3. Push **Average** on the side-bezel menu.



Averaging reduces random noise and makes it easier to see detail in a signal. In the example to the right, a ring shows on the rising and falling edges of the signal when the noise is removed.

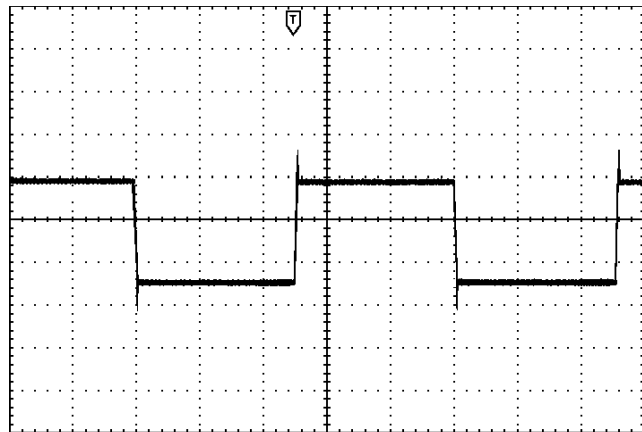

1785-176

### Taking Cursor Measurements

You can use the cursors to take quick measurements on a waveform. To measure the ring frequency at the rising edge of the signal:

1. Push channel 1 to select the channel 1 signal.

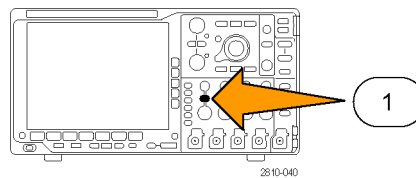

2. Push and hold **Cursors** to turn on cursors and display the Cursor menu.

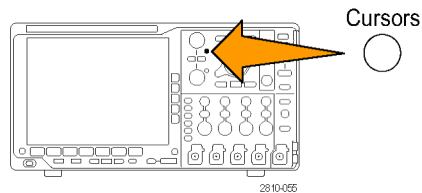

3. Push **Linked** to set Linked to **Off**.
4. Push **Bring Cursors On Screen**.
5. Push **Cursor Units**.

Cursors Waveform Screen	Bars Horizontal Vertical	Linked On <b>Off</b>	Bring Cursors On Screen	Cursor Units		
-------------------------------	--------------------------------	-------------------------	-------------------------------	-----------------	--	--



6. Push **Vertical Bar Units** from the side menu, if this choice is not already selected. Turn multipurpose knob **a** to select **Hz (1/s)** as the unit of measurement.

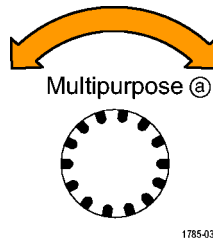

7. Push **Menu Off** to assign cursor control to the multipurpose knobs.

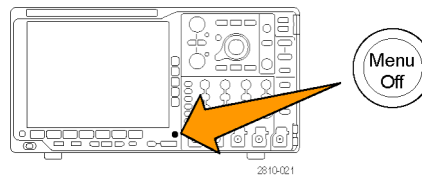

8. Place one cursor on the first peak of the ring using multipurpose knob **a**.

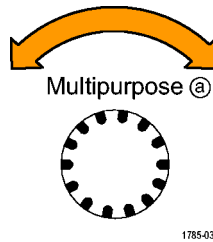

9. Place the other cursor on the next peak of the ring using multipurpose knob **b**.

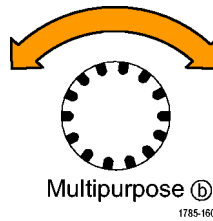

10. The cursor  $\Delta$  readout shows the measured ring frequency is 227 kHz.

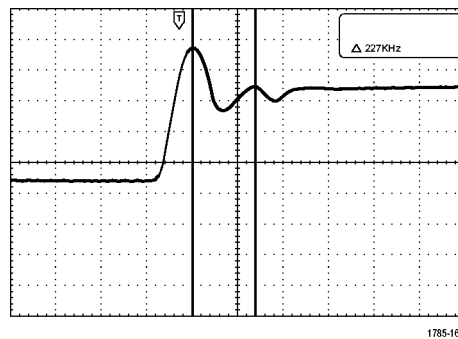

## Triggering on a Video Signal

The oscilloscope supports triggering on NTSC, SECAM, and PAL signals.

In this example, you are testing the video circuit in a piece of medical equipment and need to display the video output signal. The video output is an NTSC standard signal. Use the video signal to obtain a stable display.

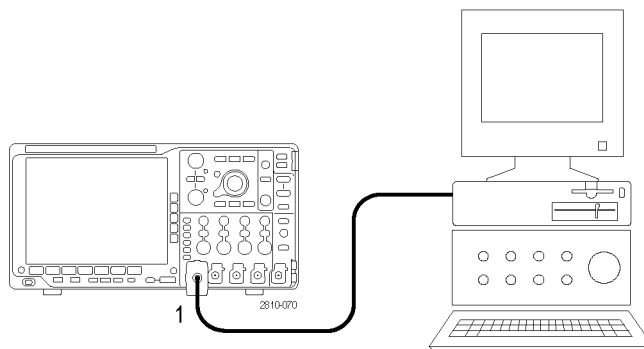

To trigger on the video fields:

1. Push **Trigger Menu**.

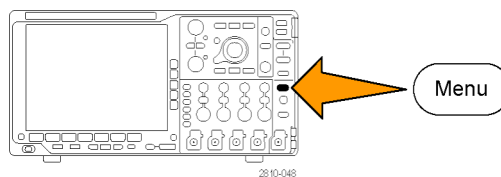

2. Push **Type**.

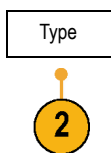

3. Turn multipurpose knob **a** to scroll through the trigger type side menu until you select **Video**.

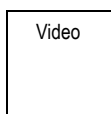

4. Push **Video Standard**, and turn multipurpose knob **a** to scroll through the standards until you select **525/NTSC**.

Type	Video Standard	Source	Trigger On			Mode
Video	525/NTSC	1	All Lines			Auto & Holdoff

5. Push **Trigger On**.



6. Select **Odd Fields**.



If the signal had been noninterlaced, you could choose to trigger on **All Fields**.

- Turn the **Horizontal Scale** knob to see a complete field across the screen.

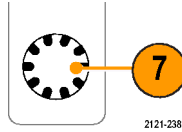

- View results.

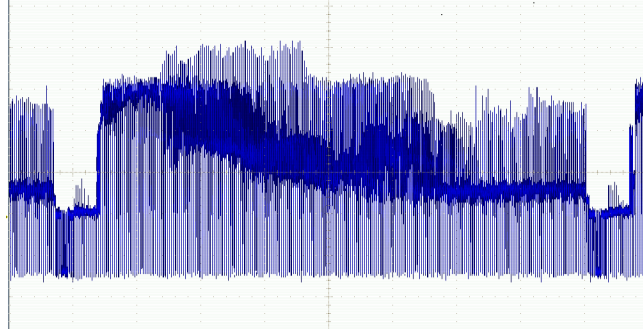

### Triggering on Lines

**Triggering on Lines.** To look at the video lines in the field:

- Push **Trigger Menu**.

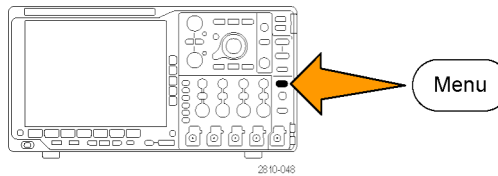

- Push **Type**.

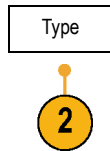

- Turn multipurpose knob **a** to scroll through the trigger type side menu until you select **Video**.

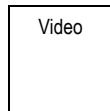

Type <b>Video</b>	Video Standard <b>525/NTSC</b>	Source <b>1</b>	Trigger On <b>All Lines</b>			Mode <b>Auto</b> & Holdoff
----------------------	-----------------------------------	--------------------	--------------------------------	--	--	----------------------------------

- Push **Trigger On**.



5. Select **All Lines**.

To trigger on a specific line, select **Line Number**, and use multipurpose knob **a** to select the line number.

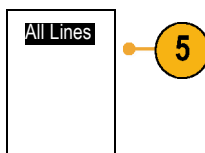

6. Adjust **Horizontal Scale** to see a complete video line across the screen.

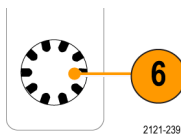

7. Observe the results.

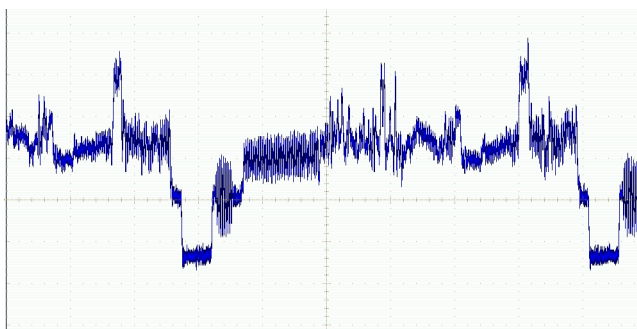

## Capturing a Single-Shot Signal

In this example, the reliability of a reed relay in a piece of equipment has been poor, and you need to investigate the problem. You suspect that the relay contacts arc when the relay opens. The fastest you can open and close the relay is about once per minute, so you need to capture the voltage across the relay as a single-shot acquisition.

To set up for a single-shot acquisition:

1. Adjust the **Vertical Scale** and **Horizontal Scale** to appropriate ranges for the signal you expect to see.
2. Push **Acquire**.

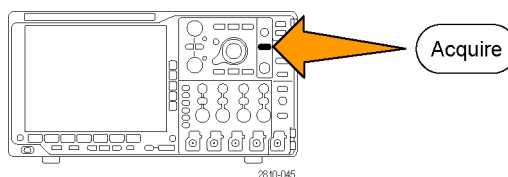

3. Push **Mode**.
4. Select **Sample**.

5. Push Trigger **Menu**.

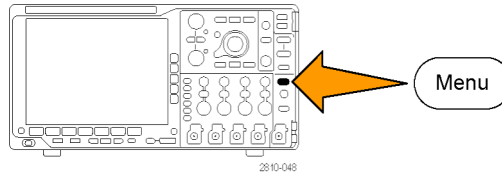

6. Push **Slope** and  $\swarrow$ .
7. Turn the **Trigger Level** knob to adjust the trigger level to a voltage midway between the open and closed voltages of the replay.

8. Push **Single** (single sequence).

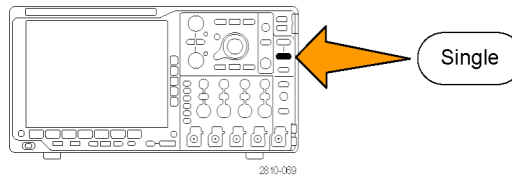



When the relay opens, the oscilloscope triggers and captures the event.

The **Single** sequence button disables auto triggering so that only a valid triggered signal is acquired.

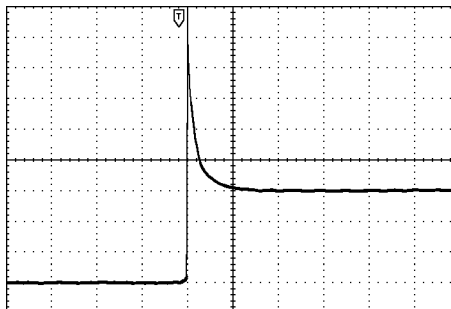

1785-171

## Optimizing the Acquisition

The initial acquisition shows the relay contact beginning to open at the trigger point. This is followed by large spikes that indicate contact bounce and inductance in the circuit. The inductance can cause contact arcing and premature relay failure.

Before you take the next acquisition, you can adjust the vertical and horizontal controls to give you a preview of how the next acquisition might appear. As you adjust these controls, the current acquisition is repositioned, expanded, or compressed. This preview is useful to optimize the settings before the next single-shot event is captured.

When the next acquisition is captured with the new vertical and horizontal settings, you can see more detail about the relay contact opening. You can now see that the contact bounces several times as it opens.

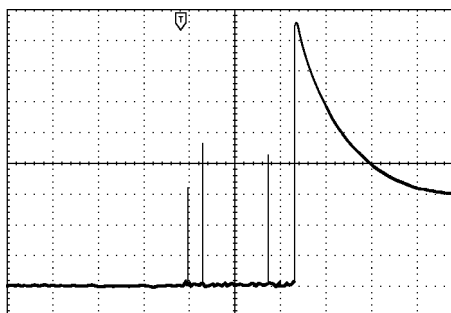

1785-173

## Using the Horizontal Zoom Function

To take a close look at a particular point on the acquired waveform, use the horizontal zoom function. To look closely at the point where the relay contact first begins to open:

1. Turn the **Zoom** knob.

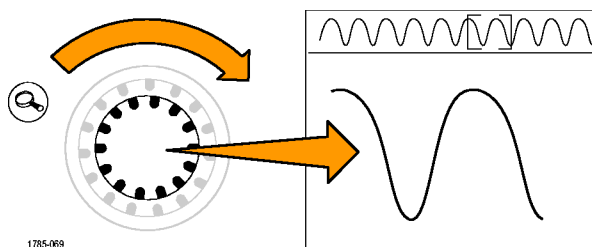

1785-069

2. Turn the **Pan** knob to place the center of the zoom box close to where the relay contact begins to open.
3. Turn the **Zoom** knob to magnify the waveform in the zoom window.

The ragged waveform and the inductive load in the circuit suggest that the relay contact may be arcing as it opens.

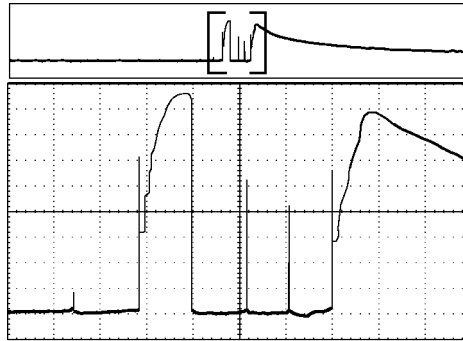

1785-173

## Correlating Data with a TLA Logic Analyzer

To troubleshoot designs with fast clock edges and data rates, it helps to view analog characteristics of digital signals in relation to complex digital events in the circuit. You can do that with iView, which lets you transfer analog waveforms from the oscilloscope to the logic analyzer display. You can then view time-correlated analog and digital signals side-by-side, and use this to pinpoint sources of glitches and other problems.

**NOTE.** Digital waveforms from 4000B Series oscilloscopes cannot be transferred to the logic analyzer display.

The USB-iView External Oscilloscope Cable Kit allows you to connect your logic analyzer to a Tektronix oscilloscope. This enables communication between the two instruments. The Add External Oscilloscope wizard, which is available from the TLA application System menu, guides you through the process of connecting the iView cable between your logic analyzer and oscilloscope.

The TLA also provides a setup window to assist you in verifying, changing, and testing the oscilloscope settings. Before acquiring and displaying a waveform, you must establish a connection between your Tektronix logic analyzer and oscilloscope using the Add External Oscilloscope wizard.

To do this:

1. Select **Add iView External Oscilloscope** from the logic analyzer System menu.

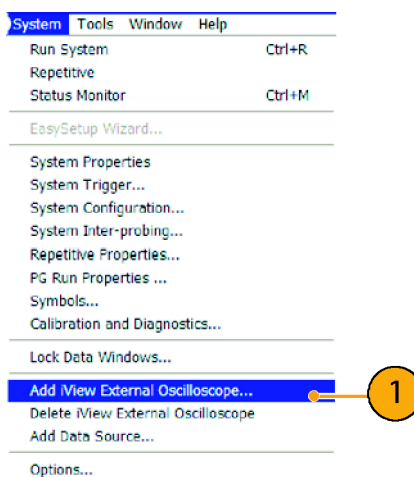

2. Select your model of oscilloscope.
3. Follow the on-screen instructions, and then click **Next**.
4. See your Tektronix Logic Analyzer documentation for more information on correlating data between your Tektronix oscilloscope and logic analyzer.

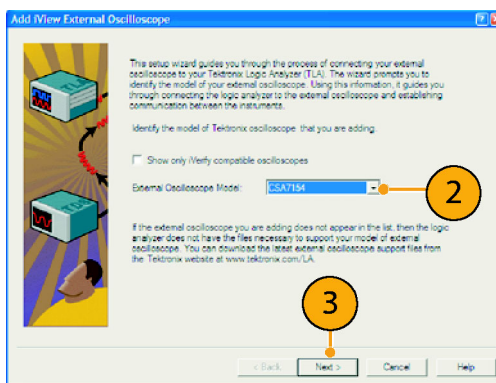

## Tracking Down Bus Anomalies

In this example, you are testing your new I<sup>2</sup>C circuit. Something is not working. You tell the master IC to send a message to the slave IC. Then you expect to receive data back and an LED to light. The light never goes on. Where in the ten or so commands that were sent out did the problem occur? Once you locate the problem location, how do you determine what went wrong?

You can use your oscilloscope, with its serial triggering and long-record length management features, to track down the problem in both the physical layer and in the protocol layer of the bus.

### Basic Strategy

First, you will display and acquire the bus signal by setting up the bus parameters and trigger. Then, you will search through each packet with the search/mark functions.

---

**NOTE.** Triggering on I<sup>2</sup>C, SPI, USB, CAN, LIN, FlexRay, RS-232, RS-422, RS-485, UART, I<sup>2</sup>S, Left Justified, Right Justified, TDM, MIL-STD-1553, and Ethernet bus signals requires use of an appropriate DPO4EMBD, DPO4USB, DPO4AUTO, DPO4AUTOMAX, DPO4COMP, DPO4AUDIO, DPO4AERO, and DPO4ENET Serial Triggering and Analysis Module. Triggering on Parallel bus signals requires an MSO4000B Series oscilloscope.

---

1. Connect the channel 1 probe to the clock line.
2. Connect the channel 2 probe to the data line.

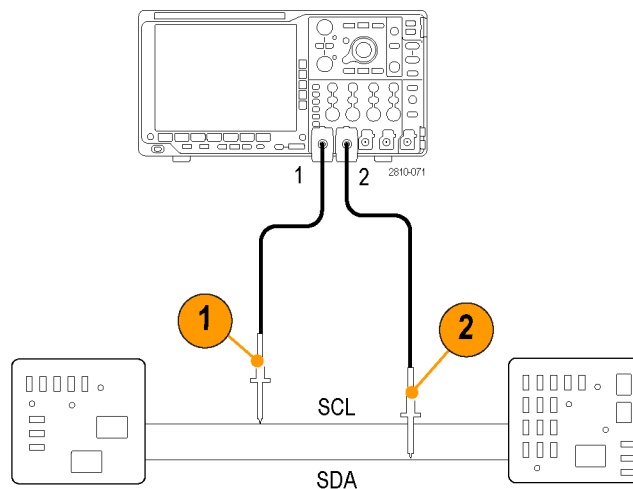

3. Push **Autoset**.

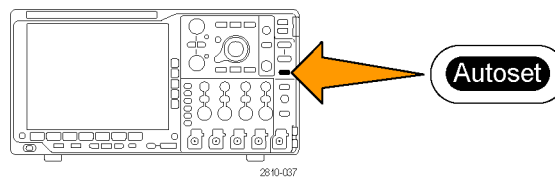

4. Push the **B1** button and enter the parameters of your I<sup>2</sup>C bus in the resulting screen menus.

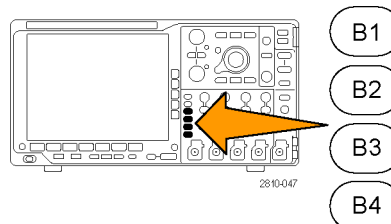

5. Push **Trigger Menu**.

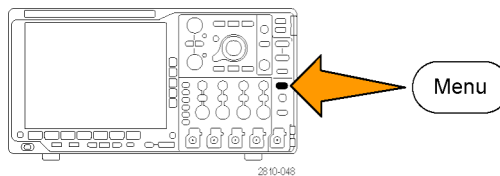

6. Push **Type** to select **Bus**. Enter trigger parameters in the resulting screen menus.

Type	Source	Trigger On	Address		Direction	Mode
Bus	Bus	Address	07F		Read	Auto & Holdoff



7. Analyze the physical layer. For example, you can use the cursors for manual measurements. (See page 108, *Taking Manual Measurements with Cursors.*) You can also use the automated measurements. (See page 99, *Taking Automatic Measurements.*)

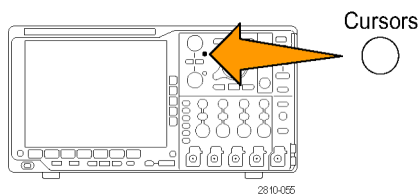

8. Push **Search**. Set **Search** to **On**. Enter a search type, source, and other parameters as relevant on the lower-bezel menu and associated side-bezel menus. (See page 122, *Using Wave Inspector to Manage Long Record Length Waveforms.*)

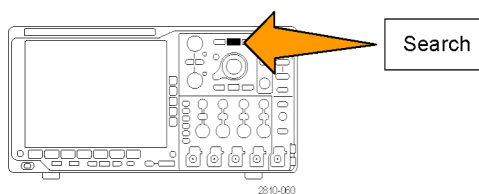

9. Jump ahead to the next search point by pushing the right arrow key. Push it again and again until you see all the events. Jump back with the left arrow key. Do you have all the packets that you expected to have? If not, at least you have narrowed your search down to the last packet sent.

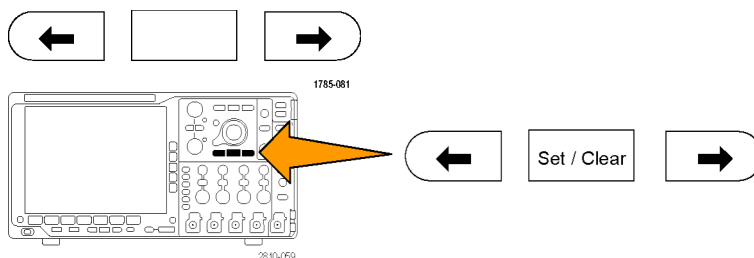

10. Analyze the decoded packets in the protocol layer. Did you send the data bytes in the correct order? Did you use the correct address?

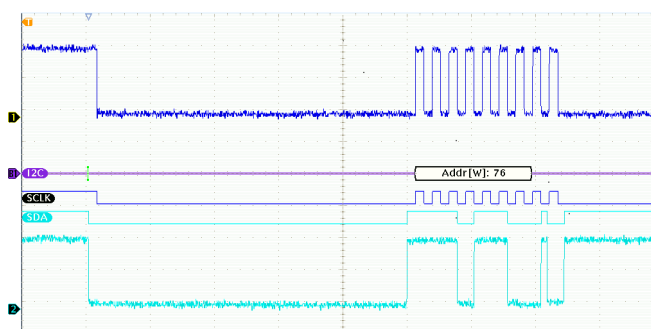

## Troubleshooting Circuits Using Parallel Buses

In this example, you are monitoring a parallel bus with your oscilloscope. You can use your MSO4000B Series oscilloscope with its 16 digital channels to analyze the bus. The MSO4000B Series will not only let you see the on-off status of the signals, but will also decode the parallel bus signals for you.

### Basic Strategy

First, you will display and acquire the digital signals. Then, you will search through the data with the search/mark functions.

---

**NOTE.** The MSO4000B Series oscilloscopes support triggering and decoding on Parallel bus signals.

---

1. Connect the desired logic probe tips to the desired test points. For simplicity, this example connects to a 7-bit counter.

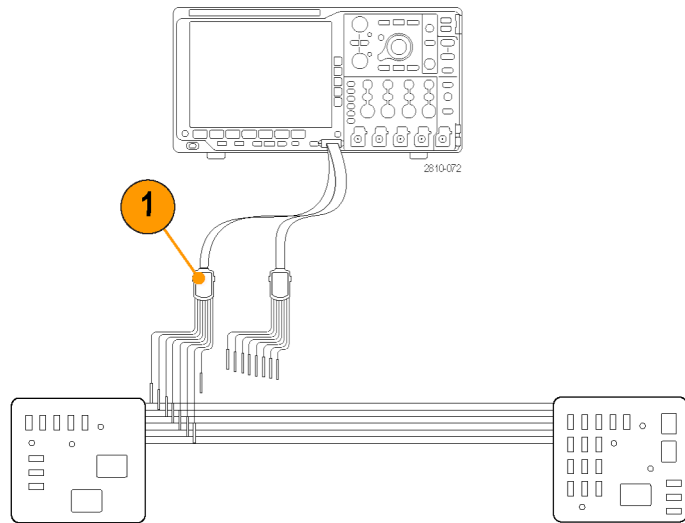

2. Push **Default Setup**. Then push the channel 1 button to remove the waveform from the display.

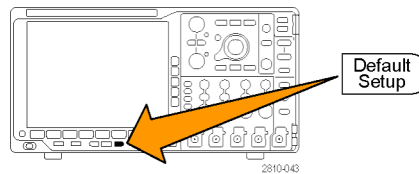

3. Push the **D15-D0** button.

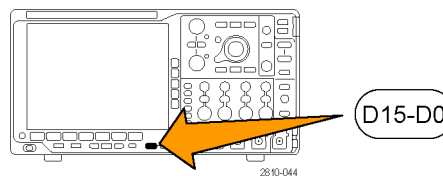

4. Push the **D15-D0 On/Off** lower-bezel button and then push the **Turn On D7-D0** side-bezel to display the digital waveforms. To turn off a channel, use multipurpose knob **a** to select the channel and push the **Display** side-bezel to select Off.

5. Push **Autoset**.

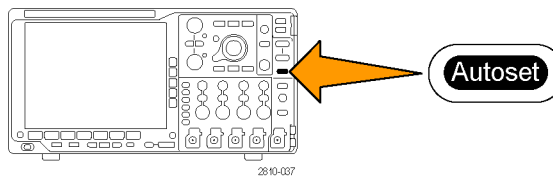

6. Push the **B1** button, select Parallel as the bus type. Push the lower-bezel **Define Inputs** and enter the parameters for your bus for Clocked Data, Clock Edge, the Number of Bits, and Define Bits.

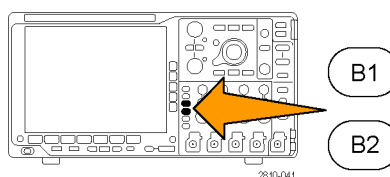

7. Turn the Horizontal Scale knob to adjust the timebase.  
As you increase the time per division, you will see more data appear in the Bus display.

8. Push **Trigger Menu**. Push **Type**, select **Bus**, and enter the parameters of the trigger, such as the Source Bus and Data. Define the Mode and Holdoff as desired.

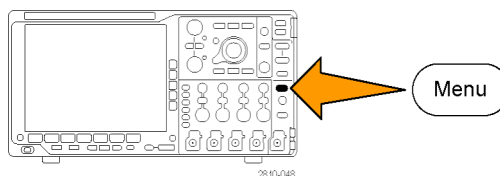

9. Push **Search**, push the **Search** lower-bezel button, and select **On** in the side-bezel menu.

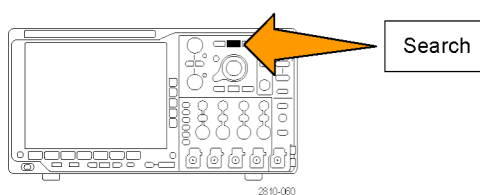

10. Push **Search Type**. Use the multipurpose knob **a** to select **Bus** and then push **Data**. Use the multipurpose knobs **a** and **b** to define the data value.
11. Push the Previous and Next Mark buttons to navigate through the record.
12. Push **Zoom**, and **Pan** to the areas of interest to analyze the results.

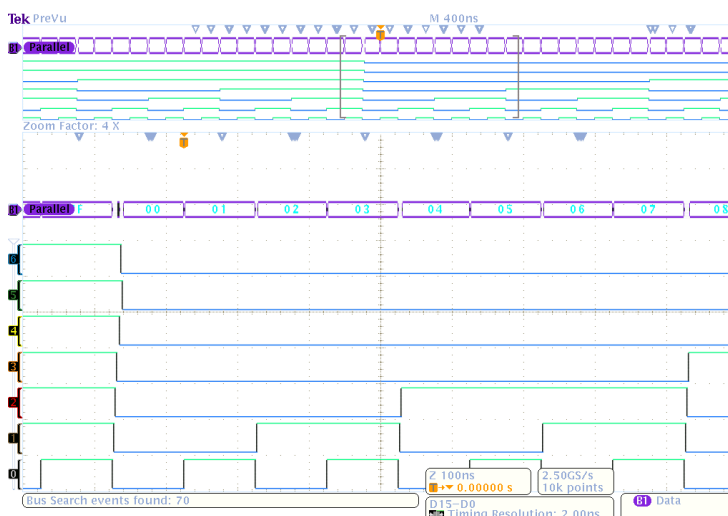

## Troubleshooting an RS-232 Bus

In this example, you are looking at analog characteristics of a digital signal in a digital circuit. You are doing this to analyze the signal integrity of a signal. For example, you might be testing RS-232 bus signals.

You can use your MSO4000B Series oscilloscope, with its up to 4 analog channels and 16 digital channels to track down the problem. It will even decode your RS-232 signals into ASCII characters.

### Basic Strategy

First, you will display and acquire the digital signal. Then, you will look at both the analog and digital representations of the signal. Finally, you will search through each RS-232 byte with the search/mark functions.

---

**NOTE.** Triggering on RS-232 bus signals requires use of the DPO4COMP Serial Triggering and Analysis Module. (See page 15, Application Module Free Trial.)

---

1. Connect the desired analog probe tip to the desired test point.

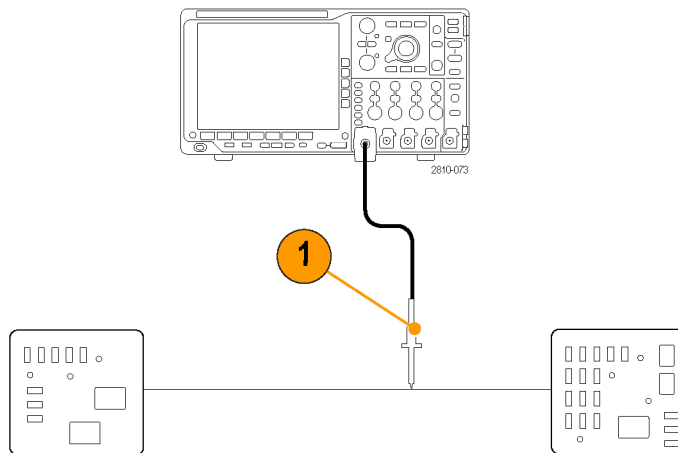

2. Push **Default Setup**.

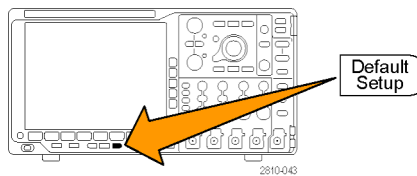

3. Push **Autoset**.

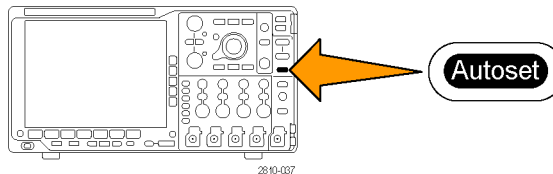



4. Push **B1**.
5. Push the **Bus B1** lower-bezel button, use multipurpose knob **a** to select **RS-232**, and enter the parameters of the bus in the resulting screen menus.

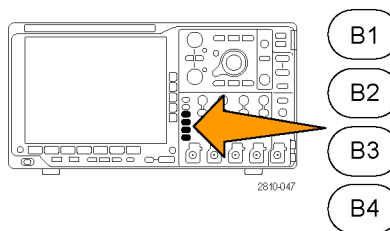

6. Push the **Bus Display** lower-bezel button, push the **Bus and Waveforms** side-bezel button, and push the **ASCII** side-bezel.
7. Turn the Horizontal Scale knob to adjust the timebase.  
As you increase the time per division, you will see more data appear in the Bus display.

8. Push **Trigger Menu**. Select the **Bus** trigger type. Define what type of condition to trigger on, such as the Tx Start Bit.

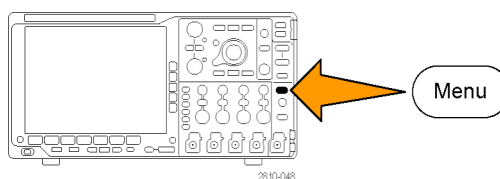

9. Push **Search**, push the **Search** lower-bezel button, and select **On** in the side-bezel menu.

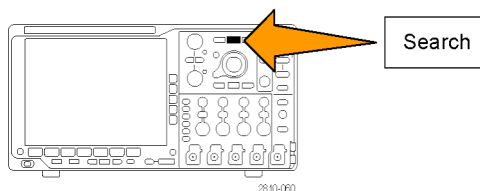

10. Push **Search Type**. Use multipurpose knob **a** to select **Bus**. Push **Search For** and select the desired search, such as for the Tx Start Bit.
11. Push the Previous and Next Mark buttons to navigate through the record.
12. Push **Zoom and Pan** to see the areas of interest and analyze the results.

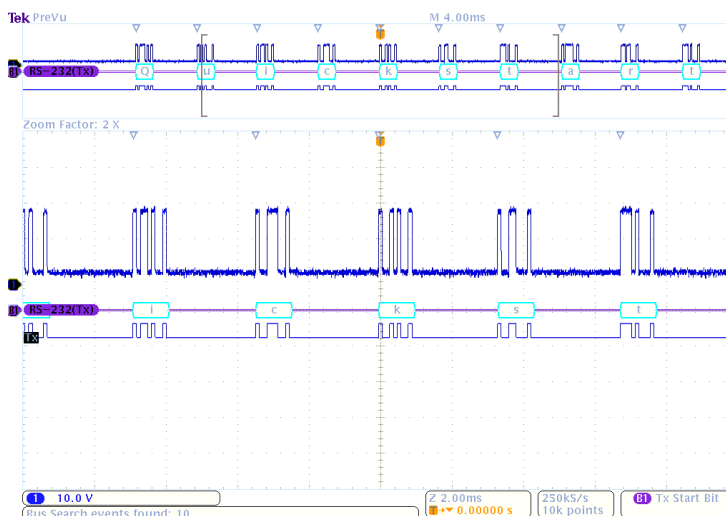

## Appendix A: MSO/DPO4000B Specifications

You can find a more complete list of MSO4000B and DPO4000B product specifications in the *MSO4000B and DPO4000B Series Oscilloscopes Technical Reference*.

These are the new user manual specifications

**Table 2: Analog channel input and vertical specifications**

Characteristic	Description		
✓ Input impedance, DC coupled	1 M $\Omega$	1 M $\Omega$ $\pm$ 1%	
	50 $\Omega$	50 $\Omega$ $\pm$ 1%	
		MSO4104B, MSO4104B-L, MSO4102B, MSO4102B-L, DPO4104B, DPO4104B-L, DPO4102B, DPO4102B-L	VSWR $\leq$ 1.5:1 from DC to 1 GHz, typical
		MSO4054B, DPO4054B	VSWR $\leq$ 1.5:1 from DC to 500 MHz, typical
		MSO4034B, DPO4034B	VSWR $\leq$ 1.5:1 from DC to 350 MHz, typical
✓ Input Capacitance, 1 M $\Omega$ DC coupled	13 pF $\pm$ 2 pF		
✓ DC Balance	0.1 div with the input DC 50 $\Omega$ coupled and 50 $\Omega$ terminated 0.2 div at 1 mV/div with the input DC 50 $\Omega$ coupled and 50 $\Omega$ terminated 0.2 div with the input DC 1 M $\Omega$ coupled and 50 $\Omega$ terminated		
✓ DC gain accuracy	MSO4104B, MSO4104B-L, MSO4102B, MSO4102B-L, DPO4104B, DPO4104B-L, DPO4102B, DPO4102B-L	For 50 $\Omega$ path: $\pm$ 1.5%, derated at 0.050%/°C above 30 °C $\pm$ 3.0% variable gain, derated at 0.050%/°C above 30 °C	
		For 1 M $\Omega$ , 250 K $\Omega$ path: $\pm$ 2.0%, derated at 0.100%/°C above 30 °C, 1 mV/Div setting $\pm$ 1.5%, derated at 0.100%/°C above 30 °C $\pm$ 3.0% variable gain, derated at 0.100%/°C above 30 °C (250 K $\Omega$ path checked indirectly.)	
	MSO4054B, DPO4054B, MSO4034B, DPO4034B	For 50 $\Omega$ path, 1M $\Omega$ , and 250 K $\Omega$ path: $\pm$ 2.0%, derated at 0.100%/°C above 30 °C, 1 mV/Div setting $\pm$ 1.5%, derated at 0.100%/°C above 30 °C $\pm$ 3.0% variable gain, derated at 0.100%/°C above 30 °C (250 K $\Omega$ path checked indirectly.)	

**Table 2: Analog channel input and vertical specifications (cont.)**

Characteristic	Description																														
✓ Offset accuracy	$\pm[0.005 \times  \text{offset} - \text{position}  + \text{DC Balance}]$ Both the position and constant offset term must be converted to volts by multiplying by the appropriate volts/div term.																														
✓ Analog bandwidth, 50 $\Omega$ , DC coupled	Full bandwidth, with amplitude tolerance of -3 dB and operating temperatures of $\leq 30$ °C (86 °F). Reduce the bandwidth by 1% for each °C above 30 °C.																														
	<table border="1"> <thead> <tr> <th>Instrument</th> <th>Volts/Div setting</th> <th>Bandwidth</th> </tr> </thead> <tbody> <tr> <td>MSO4104B, MSO4104B-L, MSO4102B, MSO4102B-L, DPO4104B, DPO4104B-L, DPO4102B, DPO4102B-L</td> <td>5 mV/div – 1 V/div</td> <td>DC to 1.00 GHz</td> </tr> <tr> <td></td> <td>2 mV/div – 4.98 mV/div</td> <td>DC to 350 MHz</td> </tr> <tr> <td></td> <td>1 mV/div – 1.99 mV/div</td> <td>DC to 175 MHz</td> </tr> <tr> <td>MSO4054B, DPO4054B</td> <td>5 mV/div – 1 V/div</td> <td>DC to 500 MHz</td> </tr> <tr> <td></td> <td>2 mV/div – 4.98 mV/div</td> <td>DC to 350 MHz</td> </tr> <tr> <td></td> <td>1 mV/div – 1.99 mV/div</td> <td>DC to 175 MHz</td> </tr> <tr> <td>MSO4034B, DPO4034B</td> <td>2 mV/div – 1 V/div</td> <td>DC to 350 MHz</td> </tr> <tr> <td></td> <td>1 mV/div – 1.99 mV/div</td> <td>DC to 175 MHz</td> </tr> </tbody> </table>	Instrument	Volts/Div setting	Bandwidth	MSO4104B, MSO4104B-L, MSO4102B, MSO4102B-L, DPO4104B, DPO4104B-L, DPO4102B, DPO4102B-L	5 mV/div – 1 V/div	DC to 1.00 GHz		2 mV/div – 4.98 mV/div	DC to 350 MHz		1 mV/div – 1.99 mV/div	DC to 175 MHz	MSO4054B, DPO4054B	5 mV/div – 1 V/div	DC to 500 MHz		2 mV/div – 4.98 mV/div	DC to 350 MHz		1 mV/div – 1.99 mV/div	DC to 175 MHz	MSO4034B, DPO4034B	2 mV/div – 1 V/div	DC to 350 MHz		1 mV/div – 1.99 mV/div	DC to 175 MHz			
Instrument	Volts/Div setting	Bandwidth																													
MSO4104B, MSO4104B-L, MSO4102B, MSO4102B-L, DPO4104B, DPO4104B-L, DPO4102B, DPO4102B-L	5 mV/div – 1 V/div	DC to 1.00 GHz																													
	2 mV/div – 4.98 mV/div	DC to 350 MHz																													
	1 mV/div – 1.99 mV/div	DC to 175 MHz																													
MSO4054B, DPO4054B	5 mV/div – 1 V/div	DC to 500 MHz																													
	2 mV/div – 4.98 mV/div	DC to 350 MHz																													
	1 mV/div – 1.99 mV/div	DC to 175 MHz																													
MSO4034B, DPO4034B	2 mV/div – 1 V/div	DC to 350 MHz																													
	1 mV/div – 1.99 mV/div	DC to 175 MHz																													
✓ Analog bandwidth, 1 M $\Omega$ , DC coupled	Full bandwidth, with amplitude tolerance of -3 dB and operating temperatures of $\leq 30$ °C (86 °F). Reduce the bandwidth by 1% for each °C above 30 °C.																														
	<table border="1"> <thead> <tr> <th>Instrument</th> <th>Volts/Div setting</th> <th>Bandwidth</th> </tr> </thead> <tbody> <tr> <td>MSO4104B, MSO4104B-L, MSO4102B, MSO4102B-L, DPO4104B, DPO4104B-L, DPO4102B, DPO4102B-L</td> <td>5 mV/div – 10 V/div</td> <td>DC to 500 MHz</td> </tr> <tr> <td></td> <td>2 mV/div – 4.98 mV/div</td> <td>DC to 350 MHz</td> </tr> <tr> <td></td> <td>1 mV/div – 1.99 mV/div</td> <td>DC to 175 MHz</td> </tr> <tr> <td>MSO4054B, DPO4054B</td> <td>5 mV/div – 10 V/div</td> <td>DC to 500 MHz</td> </tr> <tr> <td></td> <td>2 mV/div – 4.98 mV/div</td> <td>DC to 350 MHz</td> </tr> <tr> <td></td> <td>1 mV/div – 1.99 mV/div</td> <td>DC to 175 MHz</td> </tr> <tr> <td>MSO4034B, DPO4034B</td> <td>5 mV/div – 10 V/div</td> <td>DC to 350 MHz</td> </tr> <tr> <td></td> <td>2 mV/div – 4.98 mV/div</td> <td>DC to 350 MHz</td> </tr> <tr> <td></td> <td>1 mV/div – 1.99 mV/div</td> <td>DC to 175 MHz</td> </tr> </tbody> </table>	Instrument	Volts/Div setting	Bandwidth	MSO4104B, MSO4104B-L, MSO4102B, MSO4102B-L, DPO4104B, DPO4104B-L, DPO4102B, DPO4102B-L	5 mV/div – 10 V/div	DC to 500 MHz		2 mV/div – 4.98 mV/div	DC to 350 MHz		1 mV/div – 1.99 mV/div	DC to 175 MHz	MSO4054B, DPO4054B	5 mV/div – 10 V/div	DC to 500 MHz		2 mV/div – 4.98 mV/div	DC to 350 MHz		1 mV/div – 1.99 mV/div	DC to 175 MHz	MSO4034B, DPO4034B	5 mV/div – 10 V/div	DC to 350 MHz		2 mV/div – 4.98 mV/div	DC to 350 MHz		1 mV/div – 1.99 mV/div	DC to 175 MHz
Instrument	Volts/Div setting	Bandwidth																													
MSO4104B, MSO4104B-L, MSO4102B, MSO4102B-L, DPO4104B, DPO4104B-L, DPO4102B, DPO4102B-L	5 mV/div – 10 V/div	DC to 500 MHz																													
	2 mV/div – 4.98 mV/div	DC to 350 MHz																													
	1 mV/div – 1.99 mV/div	DC to 175 MHz																													
MSO4054B, DPO4054B	5 mV/div – 10 V/div	DC to 500 MHz																													
	2 mV/div – 4.98 mV/div	DC to 350 MHz																													
	1 mV/div – 1.99 mV/div	DC to 175 MHz																													
MSO4034B, DPO4034B	5 mV/div – 10 V/div	DC to 350 MHz																													
	2 mV/div – 4.98 mV/div	DC to 350 MHz																													
	1 mV/div – 1.99 mV/div	DC to 175 MHz																													

**Table 2: Analog channel input and vertical specifications (cont.)**

Characteristic	Description			
✓ Random Noise, Sample Acquisition Mode	<i>Instrument</i>	<i>Bandwidth selection</i>	<i>RMS noise (mV)</i>	
			1 MΩ                      50 Ω	
	MSO4104B, MSO4104B-L, MSO4102B, MSO4102B-L, DPO4104B, DPO4104B-L, DPO4102B, DPO4102B-L	Full Bandwidth	≤ (150 μV + 8.0% of Volts/div setting)	≤ (75 μV + 6.0% of Volts/div setting)
		250 MHz bandwidth limit	≤ (100 μV + 5.0% of Volts/div setting)	≤ (50 μV + 4.0% of Volts/div setting)
		20 MHz bandwidth limit	≤ (100 μV + 5.0% of Volts/div setting)	≤ (50 μV + 4.0% of Volts/div setting)
	MSO4054B, DPO4054B	Full Bandwidth	≤ (130 μV + 8.0% of Volts/div setting)	≤ (130 μV + 8.0% of Volts/div setting)
		250 MHz bandwidth limit	≤ (100 μV + 6.0% of Volts/div setting)	≤ (100 μV + 6.0% of Volts/div setting)
		20 MHz bandwidth limit	≤ (100 μV + 4.0% of Volts/div setting)	≤ (100 μV + 4.0% of Volts/div setting)
	MSO4034B, DPO4034B	Full Bandwidth	≤ (130 μV + 8.0% of Volts/div setting)	≤ (130 μV + 8.0% of Volts/div setting)
		250 MHz bandwidth limit	≤ (100 μV + 6.0% of Volts/div setting)	≤ (100 μV + 6.0% of Volts/div setting)
		20 MHz bandwidth limit	≤ (100 μV + 4.0% of Volts/div setting)	≤ (100 μV + 4.0% of Volts/div setting)

**Table 3: Horizontal and acquisition system specifications**

Characteristic	Description
✓ Long-term sample rate and delay time accuracy	±5 ppm over any ≥1 ms time interval

**Table 3: Horizontal and acquisition system specifications (cont.)**

Characteristic	Description
✓ Delta-time measurement accuracy	<p>The formula to calculate the delta-time measurement accuracy (DTA) for a given instrument setting and input signal is given below (assumes insignificant signal content above Nyquist and insignificant error due to aliasing):</p> <p><math>SR_1</math> = slew rate around 1st point in measurement (1<sup>st</sup> edge)  <math>SR_2</math> = slew rate around 2nd point in measurement (2<sup>nd</sup> edge)  <math>N</math> = input-referred noise (<math>V_{RMS}</math>)  <math>TBA</math> = time base accuracy (5 ppm)  <math>t_p</math> = delta-time measurement duration (sec)  <math>RD</math> = (record length)/(sample rate)  <math>t_{sr} = 1/(\text{sample rate})</math>            assume edge shape that results from Gaussian filter response</p> $DTA_{pk-pk} = \pm 5 \times \sqrt{2 \left[ \frac{N}{SR_1} \right]^2 + 2 \left[ \frac{N}{SR_2} \right]^2 + (3ps + 1 \times 10^{-7} \times RD) + 2t_{sr} + TBA \times t_p}$ $DTA_{rms} = \sqrt{2 \left[ \frac{N}{SR_1} \right]^2 + 2 \left[ \frac{N}{SR_2} \right]^2 + (3ps + 1 \times 10^{-7} \times RD)^2 + \left( \frac{2 \times t_{sr}}{\sqrt{12}} \right)^2 + TBA \times t_p}$ <p>The term under the square-root sign is the stability and is due to TIE (Time Interval Error). The errors due to this term occur throughout a single-shot measurement. The second term is due to both the absolute center-frequency accuracy and the center-frequency stability of the time base and varies between multiple single-shot measurements over the observation interval (the amount of time from the first single-shot measurement to the final single-shot measurement). The observation interval may not exceed 1 year.</p>

**Table 4: Digital acquisition specifications, MSO4000B series**

Characteristic	Description
✓ Logic threshold accuracy	<p><math>\pm(100 \text{ mV} + 3\% \text{ of threshold setting after calibration})</math>            Requires valid SPC.</p>

**Table 5: Input/Output port specifications**

<b>Characteristic</b>	<b>Description</b>
✓ Auxiliary output (AUX OUT) Trigger Out or Reference Clock Out	You can set the Auxiliary output to Trigger Out or Reference Clock Out. Reference Clock Out: Supplies the reference clock. Trigger Out: A HIGH to LOW transition indicates that the trigger occurred.
<i>Trigger output logic levels</i>	
<i>Characteristic</i>	<i>Limits</i>
Vout (HI)	≥2.5 V open circuit ≥1.0 V into a 50 Ω load to ground
Vout (LO)	≤0.7 V into a load of ≤4 mA ≤0.25 V into a 50 Ω load to ground

## Appendix B: TPP0500 and TPP1000 500 MHz and 1 GHz 10X Passive Probes Information

### Operating Information

The TPP0500 and TPP1000 10X Passive Probes are compact passive probes with 10X attenuation that are designed for use with Tektronix MSO/DPO4000B Series oscilloscopes.

The probes have no user- or Tektronix-serviceable parts.

### Connecting the Probe to the Oscilloscope

Connect the probe as shown in the illustrations below.

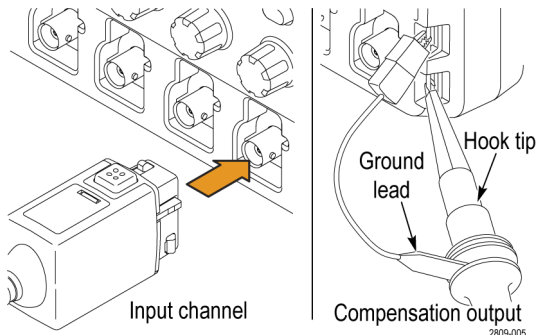

### Compensating the Probe with MSO/DPO4000B Oscilloscopes

For information on compensating the probe, refer to the related section earlier in this manual.

(See page 12, *Compensating a TPP0500 or TPP1000 Passive Voltage Probe.*)

### Standard Accessories

The standard accessories included with the probe are shown below.



**WARNING.** To avoid electric shock when using the probe or accessories, keep fingers behind the finger guard of probe body and accessories.

To reduce risk of shock, when using the probe on floating measurements, ensure the reference lead accessories are fully mated before connecting the probe to the circuit under test.

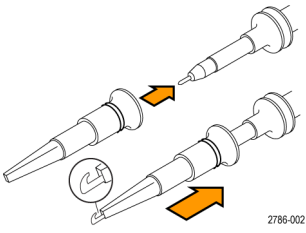
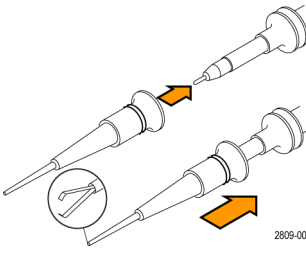
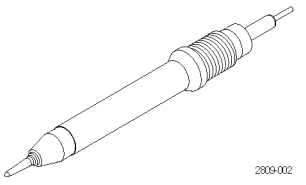
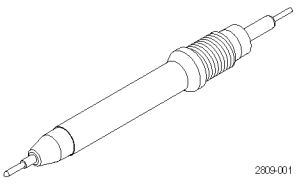
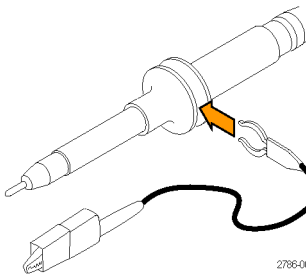
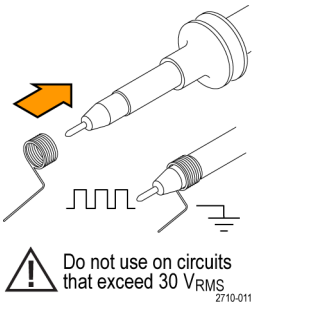
Item	Description
	<p><b>Hook tip</b></p> <p>Press the hook tip onto the probe tip and then clamp the hook onto the circuit</p> <p>Reorder Tektronix part number 013-0362-XX</p>
	<p><b>Micro Hook tip</b></p> <p>Use this tip to access test points in tight spaces. Press the hook tip onto the probe tip and then clamp the hook onto the circuit</p> <p>Reorder Tektronix part number 013-0363-XX</p>
	<p><b>Rigid tip</b></p> <p>This tip is pre-installed on the probe.</p> <p>Reorder Tektronix part number 206-0610-XX</p>
	<p><b>Pogo tip</b></p> <p>This spring-loaded tip allows compliant testing of circuit boards. The probe tip retracts slightly when pressure is applied to it and then springs back into place.</p> <p>Reorder Tektronix part number 206-0611-XX</p>
	<p><b>Ground lead, with alligator clip</b></p> <p>Secure the lead to the probe head ground and then to your circuit ground.</p> <p>Reorder Tektronix part number 196-3521-XX</p>
	<p><b>Ground springs</b></p> <p>Attach the spring to the ground band on the probe tip to take measurements on test points that have ground connections nearby (&lt;0.75 in, std; 0.375 in, short).</p> <p>Reorder Tektronix part numbers:          016-2028-XX (long, 2 ea.)          016-2034-XX (short, 2 ea.)</p>



## Optional Accessories

The following accessories can be ordered for your probe.

Accessory	Tektronix part number
Ground Lead, Clip-on, 6 in	196-3198-xx
Ground Lead, Alligator, 12 in	196-3512-xx
MicroCKT Test Tip	206-0569-xx
Circuit Board Test Point/PCB Adapter	016-2016-xx
Compact Probe Tip Ckt Board Test Point	131-4210-xx
Wire, spool, 32 AWG	020-3045-xx

## Replacing the Probe Tip

Order Tektronix part number 206-0610-xx for rigid tip replacement, or order part number 206-0611-xx for pogo pin replacement.

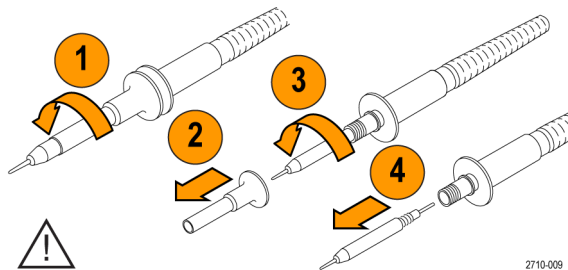

Securely tighten the insulator and new tip before using the probe.

## Specifications

**Table 6: Electrical and mechanical specifications**

Characteristic	TPP0500	TPP1000
Bandwidth (-3 dB)	500 MHz	1 GHz
System rise time (typical)	<350 ps	<700 ps
System input capacitance	Rigid tip: 3.9 pF ±0.3 pf Pogo pin tip: 5.1 pf ±0.5 pf	
System attenuation accuracy	10:1 ±2.2%	
Probe series resistance @DC	9.75 MΩ ±0.5%	
System input resistance @DC	10 MΩ ±2%	
Propagation delay	~5.67 ns	
Maximum input voltage	300 V <sub>RMS</sub> CAT II	
Cable length	1.3 m, ±3 cm	

## Performance Graphs

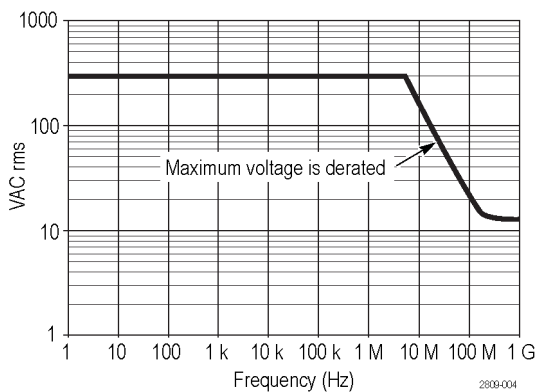
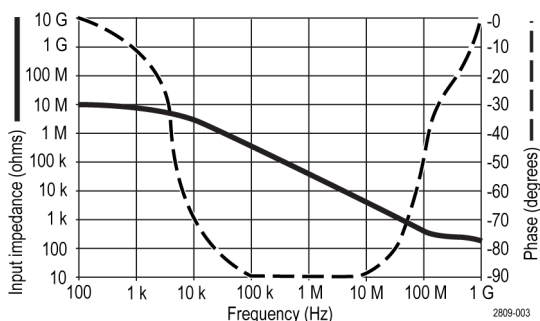

Refer to the reference lead derating curve above when making floating measurements.

**Table 7: Environmental specifications**

Characteristics	Description
Temperature	
Operating	-15 °C to +65 °C (+5 °F to +149 °F)
Nonoperating	-62 °C to +85 °C (-80 °F to +185 °F)
Humidity	
Operating	5% to 95% relative humidity @ up to 30 °C
Nonoperating	5% to 45% relative humidity @30 °C up to 50 °C
Altitude	
Operating	4.6 km (15,000 ft) maximum
Nonoperating	12.2 km (40,000 ft) maximum

**Table 8: Certifications and compliances**

Characteristics	Description								
EC Declaration of Conformity	Compliance was demonstrated to the following specification as listed in the Official Journal of the European Communities: Low Voltage Directive 2006/95/EC: EN61010-031: 2002								
Measurement Category Descriptions	<table border="1"> <thead> <tr> <th>Category</th> <th>Examples of Products in this Category</th> </tr> </thead> <tbody> <tr> <td>CAT III</td> <td>Distribution-level mains, fixed installation</td> </tr> <tr> <td>CAT II</td> <td>Local-level mains, appliances, portable equipment</td> </tr> <tr> <td>CAT I</td> <td>Circuits not directly connected to mains.</td> </tr> </tbody> </table>	Category	Examples of Products in this Category	CAT III	Distribution-level mains, fixed installation	CAT II	Local-level mains, appliances, portable equipment	CAT I	Circuits not directly connected to mains.
Category	Examples of Products in this Category								
CAT III	Distribution-level mains, fixed installation								
CAT II	Local-level mains, appliances, portable equipment								
CAT I	Circuits not directly connected to mains.								
Pollution Degree 2	Do not operate in environments where conductive pollutants may be present (as defined in IEC 61010-1). Rated for indoor use only.								
Additional Safety Standards	UL61010B-1, First Edition & UL61010B-2-031, First Edition. CAN/CSA-C22.2 No. 1010.1-92, & CAN/CSA-C22.2 No. 1010.2.031-94 IEC61010-031:2002								



**Equipment Recycling.** This product complies with the European Union's requirements according to Directive 2002/96/EC on waste electrical and electronic equipment (WEEE). For more information about recycling options, check the Support/Service section of the Tektronix Web site ([www.tektronix.com](http://www.tektronix.com)).

## Safety Summary

Review the following safety precautions to avoid injury and prevent damage to this product or any products connected to it. To avoid potential hazards, use this product only as specified. Using the probe or accessories in a manner not specified could result in a shock or fire hazard.

### To Avoid Fire or Personal Injury

**Ground-Referenced Oscilloscope Use.** Do not float the reference lead of this probe when using with ground referenced oscilloscopes (for example, DPO, MSO, and TDS series oscilloscopes). The reference lead must be connected to earth potential (0 V).

**Connect and Disconnect Properly.** Connect the probe output to the measurement instrument before connecting the probe to the circuit under test. Disconnect the probe input and the probe reference lead from the circuit under test before disconnecting the probe from the measurement instrument.

**Avoid Electric Shock.** To avoid injury or loss of life, do not connect or disconnect probes or test leads while they are connected to a voltage source.

**Observe All Terminal Ratings.** To avoid fire or shock hazard, observe all ratings and markings on the product. Consult the product manual for further ratings information before making connections to the product.

**Avoid Electric Shock.** When using probe accessories, never exceed the lowest rating of the probe or its accessory, whichever is less, including the measurement category and voltage rating.

**Avoid Electric Overload.** To avoid injury or fire hazard, do not apply potential to any input, including the reference inputs, that varies from ground by more than the maximum rating for that input.

**Avoid Exposed Circuitry and Do not Operate Without Covers.** Do not touch exposed connections and components when power is present.

**Inspect The Probe And Accessories.** Before each use, inspect probe and accessories for damage (cuts, tears, defects in the probe body, accessories, cable jacket, etc.). Do not use if damaged.

**Do Not Operate in Wet/Damp Conditions.**

**Do Not Operate in an Explosive Atmosphere.**

**Keep Product Surfaces Clean and Dry.**

**Safety Terms and Symbols Terms in This Manual.**

These terms may appear in this manual:



**WARNING.** Warning statements identify conditions or practices that could result in injury or loss of life.

---



**CAUTION.** Caution statements identify conditions or practices that could result in damage to this product or other property.

---

**Symbols on the Product.** These symbols may appear on the product:



CAUTION  
Refer to Manual

## Appendix C: P6616 General-Purpose Logic Probe Information

### Product Description

The P6616 general-purpose logic probe connects the Tektronix MSO4000B Series of mixed-signal oscilloscopes to digital buses and signals on your target system. The probe contains 16 data channels split between two lead sets (GROUP 1 and GROUP 2).

The first lead in each set is identified by blue insulation, and the remaining seven leads are gray. All leads include a ground connection at the tip. You can connect the probe leads separately to the target system, or group the leads together using the probe tip holders.

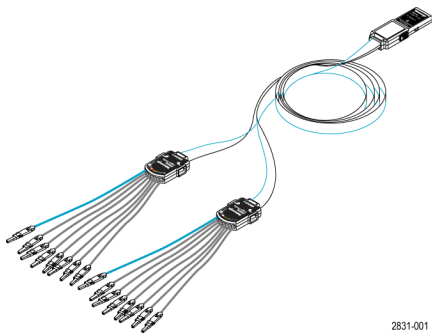

### Connecting the Probe to the Oscilloscope

Connect the probe as shown in the illustration below.

1. Insert the probe label-side up into the connector on the oscilloscope.
2. To remove the probe, squeeze the buttons on the side and pull out the probe.

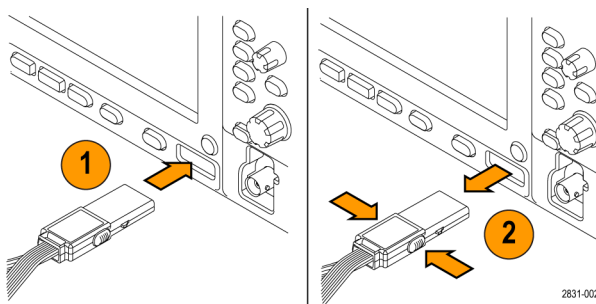

## Connecting the Probe to Your Circuit

Attach the probe to the circuit using the appropriate connectors and adapters. Select the best method for your needs, and then proceed to Setting up the Probe.

To set and view the digital channel parameters, do the following:

Push the **D15–D0** button.

The parameters listed below can be set on each digital channel:

- Threshold voltage and vertical position (the default threshold setting is 1.4 V)
- Signal height and position (set once for all 16 channels)
- Channel label

To set and view bus characteristics, do the following:

Push the **B1** to **B4** buttons.

The setup screens allow you to set and view various bus characteristics.

Parallel bus setup information is resident on mixed signal oscilloscope (MSO) models. However, for other buses such as SPI and I2C, you must have the appropriate option. (See page 54, *Setting Up a Serial or Parallel Bus*.)

## Functional Check

Logic activity immediately displays on all connected, active channels. If you do not see an active signal:

1. Push the **Trigger** button.
2. Select Edge for trigger type.
3. Select the channel that you are setting up as the source.
4. On MSO4000B Series instruments, push the **Autoset** button.

If you do not see an active signal, try another probe channel (or analog probe) to verify circuit activity at the test point.

## Typical Application

1. Use the P6616 probe to view digital signals on a system bus.
2. Use an analog probe, such as the TPP0500 or TPP1000 passive probe, to view analog waveform information.

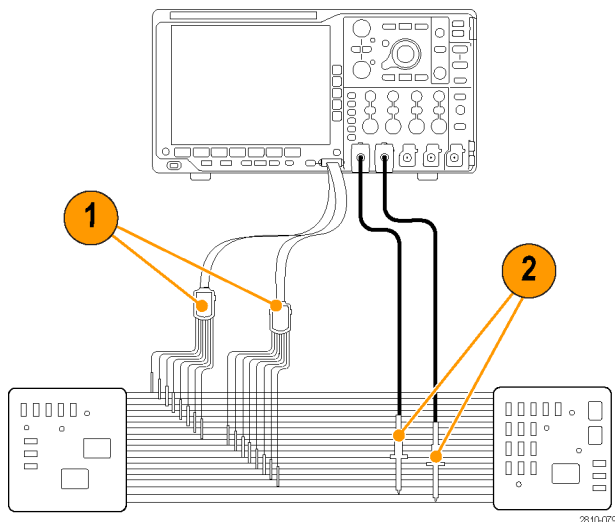

## Accessories

The following standard accessories ship with the probe and are shown in the illustration on the following page.

Item	Description	Quantity	Part number
—	Logic probe accessory kit	Item 1–6	020-2662-XX
1	Extension ground tip	1 set of 20	020-2711-XX
2	Probe tip	1 set of 10	131-5638-11
3	IC grabber	1 set of 20	020-2733-XX
4	Probe tip holder	2 ea	352-1115-XX
5	8" Ground lead	1 set of 2	020-2713-XX
6	3" Ground lead	1 set of 8	020-2712-XX
	Instructions <sup>1</sup>	1 ea	071-2831-XX

<sup>1</sup> Instructions are included with the probe, but not in the accessory kit. The instructions can be downloaded at [www.tektronix.com/manuals](http://www.tektronix.com/manuals).

These optional accessories can be ordered for your probe:

Description	Part number
P6960 Probe D-MAX Footprint to Square Pin Header Adapter	NEX-P6960PIN



## Specifications

**Table 9: Electrical and mechanical specifications**

Characteristic	Description
Input channels	16 digital
Input resistance	100 k $\Omega$ $\pm$ 1.0%
Input capacitance	3.0 pF
Input signal swing	
Minimum	400 mV p-p
Maximum	30 V p-p, $\leq$ 200 MHz (centered around the DC threshold voltage) at the probe tip 10 V p-p, $\geq$ 200 MHz (centered around the DC threshold voltage) at the probe tip
Maximum nondestructive input signal	$\pm$ 42 V
User defined threshold range	$\pm$ 40 V
Minimum detectable pulse width	1 ns
Digital channel-to-digital channel skew	200 ps
Probe length	1.3 m (4.27 ft)
Maximum input toggle rate	500 MHz

**Table 10: Environmental specifications**

Characteristic	Description
Temperature	
Operating	0 °C to +50 °C (+32 °F to +122 °F)
Nonoperating	-55 °C to +75 °C (-67 °F to +167 °F)
Humidity	
Operating	5% to 95% relative humidity
Nonoperating	10% to 95% relative humidity
Altitude	
Operating	4.6 km (15,092 ft) maximum
Nonoperating	15 km (50,000 ft) maximum



**Equipment Recycling.** This product complies with the European Union's requirements according to Directive 2002/96/EC on waste electrical and electronic equipment (WEEE). For more information about recycling options, check the Support/Service section of the Tektronix Web site ([www.tektronix.com](http://www.tektronix.com)).

## Safety Summary

To avoid potential hazards, use this probe only as specified.

**Connect and Disconnect Properly.** Connect the probe output to the measurement instrument before connecting the probe to the circuit under test. Disconnect the probe input and the probe ground from the circuit under test before disconnecting the probe from the measurement instrument.

**Observe All Terminal Ratings.** To avoid fire or shock hazard, observe all ratings and markings on the product. Consult the product manual for further ratings information before making connections to the product.

**Do not Operate Without Covers.** Do not touch exposed connections and components when power is present.

**Avoid Exposed Circuitry.** Do not touch exposed connections and components when power is present.

**Do Not Operate With Suspected Failures.** If you suspect there is damage to this product, have it inspected by qualified service personnel.

**Do Not Operate in Wet/Damp Conditions.** Do Not Operate in an Explosive Atmosphere.

**Keep Product Surfaces Clean and Dry.**

## Safety Terms and Symbols in This Manual.

These terms may appear in this manual:



---

**WARNING.** *Warning statements identify conditions or practices that could result in injury or loss of life.*

---



---

**CAUTION.** *Caution statements identify conditions or practices that could result in damage to this product or other property.*

---

**Symbols on the Product.** This symbol may appear on the product:



CAUTION  
Refer to Manual

# Index

## Symbols and Numbers

50  $\Omega$  protection, 93

## A

About, 23  
 Accessories, 1  
 Acquire button, 31, 51, 84, 159, 160  
 Acquisition  
   input channels and digitizers, 49  
   modes defined, 51  
   readout, 37  
   sampling, 49  
 Adapter  
   TEK-USB-488, 3  
   TPA-BNC, 3, 8  
 Adding waveform, 84  
 Advanced math, 119  
 Altitude, 5  
 Amplitude measurement, 101  
 Annotating the screen, 96  
 Application modules, 15, 151  
   30-day free trial, 15  
   DPO4AERO, 2, 54  
   DPO4AUDIO, 2, 54  
   DPO4AUTO, 2, 54  
   DPO4AUTOMAX, 2, 54  
   DPO4COMP, 3, 54  
   DPO4EMBD, 3, 54  
   DPO4ENET, 3, 54  
   DPO4LMT, 3  
   DPO4PWR, 3, 54  
   DPO4USB, 3, 54  
   DPO4VID, 3, 76  
   license transfers, 15  
 Area measurement, 103  
 Audio  
   bus trigger, 78  
 Auto trigger mode, 70  
 Autoset, 48, 152  
   Video, 49  
 Autoset button, 12, 31, 35, 45, 48, 152  
 Autoset disable, 48  
 Autoset undo, 48  
 Aux In connector, 41  
 Auxiliary Output (AUX OUT), 42

Auxiliary readout, 40  
 Average acquisition mode, 51

## B

B trigger, 82  
 B1 / B2 / B3 / B4, 54, 55, 76  
 Backlight intensity, 88  
 Bandwidth, xi, 91  
 Baseline indicators, 40  
 Before Installation, 1  
 Blackman-Harris FFT window, 119  
 Blue lines, 96  
 BNC interface, 8  
 Burst Width measurement, 101  
 Bus  
   button, 54, 55, 76  
   display, 41, 57  
   menu, 32, 55  
   positioning and labeling, 94  
   setup, 55  
 Bus and Waveforms display  
   show physical layer bus activity, 66  
 Bus trigger, defined, 76  
 Buses, 54, 76  
   cursor readout, 111

## Button

Acquire, 31, 51, 84, 159, 160  
 Autoset, 12, 31, 35, 45, 48, 152  
 B1 / B2 / B3 / B4, 32, 54, 55, 76  
 bus, 54, 55, 76  
 Channel, 32  
 Cursors, 33, 108  
 D15 - D0, 36, 69  
 Default Setup, 36, 44, 47  
 Fine, 31, 33, 34, 35  
 Force Trig, 35, 70  
 hard copy, 36, 148  
 Intensity, 88  
 M, 33, 115, 116  
 Math, 33, 115, 116  
 Measure, 31, 99, 105, 106, 153, 155, 156, 157  
 Menu Off, 37, 153  
 Next, 34  
 Play-pause, 34, 123  
 Previous, 34  
 Print, 36  
 printer, 148  
 Ref, 33, 120, 138  
 Run/Stop, 35, 53, 83  
 Save / Recall, 32, 36, 136  
 Search, 31, 125  
 Select, 33  
 Set / Clear Mark, 34, 124  
 Set to 50%, 35, 72  
 Single, 35, 83, 157, 166  
 Test, 31  
 Trigger, 31  
 Trigger level, 35  
 Trigger menu, 73, 163  
 Utility, 16, 17, 19, 31, 85, 87, 96, 97, 144  
 Vertical, 32  
 Zoom, 34  
 byte matching, 80

## C

Calibration, 19, 20  
 Calibration certificate, 1  
 CAN, 32, 54, 76  
   bus trigger, 78

- Channel
    - button, 32
    - readout, 40
    - vertical menu, 90
  - Cleaning, 7
  - Clearance, 7
  - Communications, 23, 25
  - Compensate
    - non-TPP500 or non-TPP1000 probe, 14
    - signal path, 19
    - TPP500 or TPP1000 probe, 12
  - Confidential data, 149
  - Connecting
    - a USB keyboard, 27
    - to a PC, 23
    - Your oscilloscope, 23
  - Connectivity, 1, 23, 25
  - Connectors
    - front-panel, 41
    - rear-panel, 42
    - side-panel, 41
  - Controls, 29
  - Copy a drive, directory, or file, 142
  - Coupling, 90
  - Coupling, trigger, 71
  - Cover, front, 2
  - Create new folder, 142
  - Cross Hair graticule style, 87
  - Cursor readout, 38, 111
  - Cursors, 108
    - button, 33, 108
    - linking, 109
    - measurements, 108
    - menu, 108
    - XY, 112
  - Cycle Area measurement, 103
  - Cycle Mean measurement, 102
  - Cycle RMS measurement, 102
- D**
- D15 - D0 button, 36, 69
  - Date and time, changing, 17
  - Default Setup, 47, 141
    - button, 36, 44, 47
    - menu, 36
    - Undo, 48
  - Delay measurement, 100
  - Delay time, 53
  - Delayed trigger, 81
  - Delete directory or file, 142
  - Depth, 5
  - Deskew, 92
  - dI/dt, 3
  - Digital channels, 96
    - Baseline indicators, 40
    - Group icon, 40
    - scaling, positioning, grouping, and labeling, 94
    - setup, 67
  - Disable AutoSet, 48
  - Display
    - information, 37
    - persistence, 84
    - style, 84
    - XY, 85
  - Displaying, reference waveforms, 138
  - DPO4AERO, 2, 54, 151
  - DPO4AUDIO, 2, 54, 151
  - DPO4AUTO, 2, 54, 151
  - DPO4AUTOMAX, 2, 54, 151
  - DPO4COMP, 3, 54, 151
  - DPO4EMBD, 3, 54, 151
  - DPO4ENET, 3, 54, 151
  - DPO4LMT, 3, 127, 151
  - DPO4PWR, 3, 54, 151
  - DPO4USB, 3, 54, 151
  - DPO4VID, 3, 76, 151
  - Drivers, 23, 25
  - Dual waveform math, 115
  - dV/dt, 3
- E**
- e\*Scope, 25
  - Edge trigger, defined, 74
  - Edges
    - Fuzzy, 96
    - White, 96
  - Envelope acquisition mode, 51
  - Erase setup and ref memory, 149
  - Ethernet, 24, 25, 26, 32, 54, 76
    - bus trigger, 79
    - port, 42
    - printing, 146
  - Event Table, 57
  - Excel, 23, 25
  - Expansion point, 50
  - Expansion point icon, 38
  - EXT REF IN, 42
- F**
- Factory calibration, 20
  - Fall Time measurement, 100
  - Falling Edge Count measurement, 102
  - FFT
    - Blackman-Harris, 119
    - controls, 116
    - Hamming, 118
    - Hanning, 119
    - Rectangular, 118
  - File format, 136
    - Internal File Format (ISF), 138
  - File names, 134
  - File system, 134, 138
  - Fine, 34
  - Fine button, 31, 33, 34, 35
  - Firmware
    - upgrade, 20
    - version, 23
  - firmware.img file, 20
  - Flash drive, 25
  - FlexRay, 32, 54, 76
    - bus trigger, 78
  - Force Trig button, 35, 70
  - Format a drive, 142
  - Frame graticule style, 87
  - Frequency measurement, 100
  - Front cover, 2
  - Front panel, 29
  - Front-panel connectors, 41
  - Front-panel overlay, 17
  - Full graticule style, 87
  - Functional check, 11
  - Fuzzy edges, 96
- G**
- Gating, 104
  - GPIO, 23, 43
  - GPIO address, 25
  - Graticule
    - Cross Hair, 87
    - Frame, 87
    - Full, 87
    - Grid, 87
    - intensity, 88
    - IRE, 87
    - mV, 87
    - Solid, 87
    - styles, 85
  - Green lines, 96
  - Grid graticule style, 87

Ground, 10  
 lead, 15  
 strap, 10  
 strap connector, 41  
 Ground yourself to discharge static, 10  
 Group icon, 40  
 Grouping channels, 68  
 digital, 94

## H

Hamming FFT window, 118  
 Hanning FFT window, 119  
 Hard copy, 143  
 Hard copy button, 36  
 Height, 5  
 Hi Res acquisition mode, 51  
 High measurement, 101  
 High-low indicators, 40  
 Histogram (waveform)  
 reset the count, 114  
 setup, 112  
 Histogram measurements, 103  
 Hits in Box measurement, 103  
 Holdoff, trigger, 71  
 Horizontal delay, 71  
 Horizontal lines  
 Green and blue, 96  
 Horizontal position, 35, 50, 71, 72, 89, 118, 168  
 and math waveforms, 116  
 defined, 45  
 readout, 39  
 Horizontal scale, 35, 89, 118, 164, 165, 168  
 and math waveforms, 116  
 defined, 45  
 readout, 39

How to  
 calibrate a TPP0500 or TPP1000 voltage probe, 12  
 compensate a non-TPP0500 or non-TPP1000 voltage probe, 14  
 compensate the signal path, 19  
 connect probes and adapters, 8  
 connect to a computer, 23  
 erase memory, 149  
 label channels and buses, 45  
 manage long record length waveforms, 122  
 perform a functional check, 11  
 power off the oscilloscope, 11  
 power on the oscilloscope, 10  
 print a hard copy, 143  
 recall setups, 139  
 recall waveforms, 136  
 save screen images, 136  
 save setups, 139  
 save waveforms, 136  
 search through and add marks to waveforms, 124  
 select a trigger, 74  
 select automatic measurements, 100  
 setup a waveform histogram, 112  
 setup analog channels, 44  
 setup bus parameters, 55  
 setup digital channels, 67  
 setup input parameters, 90  
 setup VISA communications, 23  
 take automatic measurements, 99  
 take manual measurements with cursors, 108  
 trigger on buses, 76  
 upgrade the firmware, 20  
 use a sequential trigger, 81  
 use e\*Scope, 25  
 use MagniVu, 69  
 use Wave Inspector, 122  
 Humidity, 5

## I

I2C, 32, 54, 76  
 I2S, 32, 54, 76

Icon  
 Expansion point, 38  
 Trigger level, 39  
 Trigger position, 38  
 Image orientation, 136, 144  
 Impedance, 90  
 Indicator, waveform baseline, 40  
 Infinite persistence, 85  
 Ink Saver, 136, 145  
 Inner knob, 34, 116  
 Intensity button, 88  
 Internal File Format (ISF), 138  
 Invert, 90  
 IRE graticule, 87  
 ISF format, 138

## K

Keyboard  
 Connection, 27  
 Key layout style, 27  
 language, 16  
 Knob  
 inner, 34, 116  
 Multipurpose, 18, 31, 34, 52, 138, 162  
 outer, 34  
 pan, 34, 123, 124  
 Trigger level, 72  
 Vertical menu, 35  
 Vertical position, 35, 45  
 Vertical scale, 35, 45  
 zoom, 34, 116, 122

## L

Label bus, 94  
 LabVIEW SignalExpress, 23, 25  
 LAN port, 42  
 Landscape, 136, 144  
 Language  
 change, 16  
 overlay, 17  
 Left Justified (LJ), 32, 54, 76  
 Level, trigger, 72  
 License transfers for application modules, 15  
 Limit testing, 127  
 LIN, 32, 54, 76  
 bus trigger, 78  
 Linked cursors, 109  
 Lock, standard laptop, 9  
 Logic probe interface, 8

Logic trigger, defined, 75  
 Long record length, 170  
   management, 122  
 Low measurement, 101  
 LXI, 26  
 LXI Class C, 42

## M

M button, 33, 115, 116  
 MagniVu, 69  
 MagniVu readout, 39  
 Main trigger, 81  
 Mark, 124  
 Mask testing, 127  
 Math  
   Advanced, 119  
   button, 33, 115, 116  
   Dual waveform, 115  
   FFT, 116  
   menu, 33  
   waveforms, 115  
 Max measurement, 102, 103  
 Mean measurement, 102, 103  
 Measure button, 31, 99, 105, 106,  
   153, 155, 156, 157  
 Measurement menu, 31  
 Measurements  
   automatic, 99  
   cursor, 108  
   defined, 100  
   histogram, 103  
   reference levels, 107  
   snapshot, 106  
   statistics, 105  
 Median measurement, 103  
 Memory, erasure of, 149  
 Menu, 29  
   Bus, 32, 55  
   buttons, 31  
   Cursors, 108  
   Default Setup, 36  
   Math, 33  
   Measurement, 31  
   Reference, 33, 120, 121  
   Save / Recall, 32, 36, 136  
   Trigger, 31, 73, 81, 163  
   Utility, 16, 18, 31, 36, 85, 97,  
     98, 144  
   Vertical, 32, 90  
 Menu Off button, 37, 153

Microsoft  
   Excel, 25  
   Word, 25  
 MIL-STD-1553, 32, 54, 76  
   bus trigger, 79  
   data value matching, 80  
 Min measurement, 102, 103  
 Mode, roll, 53  
 Mount or unmount a networked  
   drive, 142  
 Multiple transition detection, 96  
 Multipurpose knob, 31, 34, 52, 138,  
   162  
 mV graticule, 87

## N

Negative Duty Cycle  
   measurement, 100  
 Negative Overshoot  
   measurement, 101  
 Negative Pulse Count  
   measurement, 102  
 Negative Pulse Width  
   measurement, 100  
 Network printing, 146  
 Networked drives, mounting and  
   unmounting, 142  
 NEX-HD2HEADER, 3  
 Next button, 34  
 NI LabVIEW SignalExpress, 1  
 Normal trigger mode, 70

## O

Offset and position, 93  
 Offset vertical, 91  
 OpenChoice, 1  
 OpenChoice Desktop, 25  
 Operating specifications, 5  
 Orientation of the image, 136, 144  
 Outer knob, 34  
 Overlay, 17

## P

P6616, 2, 7, 68  
   probe ground leads, 67  
 Pan, 122, 123  
   knob, 34, 123, 124  
 Parallel bus, 54, 76  
   anomalies, 172  
   trigger, 76, 77

Pause, 123  
 Peak detect acquisition mode, 51  
 Peak Hits measurement, 103  
 Peak-to-peak measurement, 103  
 Period measurement, 100  
 Persistence  
   display, 84  
   infinite, 85  
   variable, 85  
 Phase measurement, 101  
 Physical layer bus activity, 66  
 PictBridge, 25, 43, 143  
 Pk-Pk measurement, 101  
 Play, 123  
 Play-pause  
   button, 34, 123  
   mode, 123  
 Pollution Degree, 5  
 Portrait, 136, 144  
 Position  
   bus, 94  
   digital channels, 94  
   Horizontal, 71, 72, 89, 118, 168  
   Vertical, 89  
 Position and offset, 93  
 Positive Duty Cycle  
   measurement, 100  
 Positive Overshoot  
   measurement, 101  
 Positive Pulse Count  
   measurement, 102  
 Positive Pulse Width  
   measurement, 100  
 Posttrigger, 70, 72  
 Power  
   cord, 2  
   input, 43  
   off, 11  
   removing, 11  
   supply, 10  
   switch, 36  
 Power consumption, 5  
 Predefined math expressions, 115  
 Pretrigger, 70, 72  
 Previous button, 34  
 Print, 144  
   Ethernet, 146  
   hard copy, 143  
 Print button, 36  
 Probe Comp, 12, 13  
 PROBE COMP connector, 41

- Probe compensation
    - non-TPP0500 or non-TPP1000, 14
    - TPP0500 or TPP1000, 12
  - Probe connector
    - analog, 41
    - logic, 41
  - Probes
    - BNC, 8
    - connecting, 8
    - ground lead, 15
    - logic, 8
    - P6616, 2, 188
    - TEK-USB-488 Adapter, 3
    - TekVPI, 8
    - TPA-BNC Adapter, 3, 8
    - TPP0500, 2, 181
    - TPP1000, 2, 181
  - Pulse Width trigger, defined, 74
- ## R
- Rackmount, 3
  - Readout
    - Acquisition, 37
    - Auxiliary, 40
    - Channel, 40
    - Cursor, 38, 111
    - Horizontal position/scale, 39
    - MagniVu, 39
    - Record length/sampling rate, 39
    - Timing resolution, 39
    - Trigger, 39, 80
    - Trigger frequency, 97
    - Trigger status, 38
  - Real-time sampling, 50
  - Rear-panel connectors, 42
  - Recalling
    - setups, 139
    - waveforms, 136
  - Record length, xi, 50
  - Record length/sampling rate readout, 39
  - Rectangular FFT window, 118
  - Ref button, 33, 120, 138
  - Ref R, 138
  - Reference levels, 107
  - Reference menu, 33, 120, 121
  - Reference waveforms, 120
    - displaying, 138
    - removing, 121, 139
    - saving, 138
    - saving 10 M and 20 M waveforms, 121
  - Removing reference waveforms, 121, 139
  - Removing waveform, 84
  - Rename a drive, directory, or file, 142
  - Right Justified (RJ), 32, 54, 76
  - Rise Time measurement, 100
  - Rise/Fall trigger, defined, 75
  - Rising Edge Count measurement, 102
  - RMS measurement, 102
  - Roll mode, 53
  - Rolling window data matching, 79
  - RS-232, 32, 54, 76
    - bus example, 174
    - bus trigger, 78
    - cursor readout, 111
    - data value matching, 80
    - decoding, 61
  - RS-422, 32, 54
  - RS-485, 32, 54
  - Run/Stop button, 35, 53, 83
  - Runt trigger, defined, 74
- ## S
- Safety Summary, v
  - Sample acquisition mode, 51
  - Sample interval, 50
  - Sample rates, xi
  - Sampling process, defined, 49
  - Sampling, real-time, 50
  - Save / Recall menu, 32, 36, 136
  - Save / Recall Menu button, 32
  - Save / Recall Save button, 36, 136
  - Saving
    - reference waveforms, 138
    - screen images, 136
    - setups, 139
    - waveforms, 136
  - Saving and recalling Information, 134
  - Scale
    - digital channels, 94
    - Horizontal, 35, 89, 118, 164, 165, 168
    - Vertical, 89, 165
  - Screen annotations, 96
  - Search, 124
  - Search button, 31, 125
  - Search marks, 171
  - Securing memory, 149
  - Security lock, 9
  - Select button, 33
  - Selecting a keyboard key layout style, 27
  - Sequence (B Trigger), defined, 74
  - Sequential triggering, 81
  - Serial bus, 54, 170
    - trigger, 76
  - Set / Clear Mark button, 34, 124
  - Set to 50% button, 35, 72
  - Setup
    - default, 36, 44, 47, 141
  - Setup and Hold trigger, defined, 75
  - Side panel connector, 41
  - Sigma1 measurement, 103
  - Sigma2 measurement, 103
  - Sigma3 measurement, 103
  - Signal path compensation, 19
  - Single button, 35, 83, 157, 166
  - Single sequence, 53, 83
  - Slew rate, 3
  - Slope, trigger, 72
  - Snapshot, 106
  - Socket Server, 24
  - Software drivers, 23, 25
  - Software, optional, 151
  - Solid graticule style, 87
  - SPC, 19
  - Specifications
    - operating, 5
    - power supply, 10
  - SPI, 32, 54, 76
  - SPI bus trigger, 77
  - Standard Deviation measurement, 103
  - Start an acquisition, 83
  - Statistics, 105
  - Stop an acquisition, 83
  - Switch, power, 36
- ## T
- Table, Event, 57
  - TDM, 32, 54, 76
  - TEK-USB-488 Adapter, 3, 23, 25, 43
  - TekSecure, 149
  - TekVPI, 8

- Temperature, 5
  - Termination, 90
  - Test button, 31
  - Timing resolution readout, 39
  - TPA-BNC Adapter, 3, 8
  - TPP0500 or TPP1000
    - compensation, 12
  - TPP0500 probe, 2
  - TPP0500, TPP1000, 7
  - TPP1000 probe, 2
  - Transit case, 3
  - Transition trigger, defined, 75
  - Trigger
    - Audio bus, 78
    - B trigger after delay time, 82
    - Bus, defined, 76
    - buses, 76
    - byte matching, 80
    - Can bus, 78
    - concepts, 70
    - coupling, 71
    - data matching on a rolling
      - window, 79
    - delayed, 81
    - Edge, defined, 74
    - Ethernet bus, 79
    - event, defined, 70
    - FlexRay bus, 78
    - forcing, 70
    - Frequency readout, 97
    - holdoff, 71
    - level, 72
    - level button, 35
    - level icon, 39
    - level knob, 72
    - LIN bus, 78
    - Logic, defined, 75
    - MIL-STD-1553 bus, 79
    - MIL-STD-1553 data value
      - matching, 80
    - modes, 70, 73
    - Parallel bus, 77
    - parallel bus data matching, 80
    - parallel buses, 54
    - point, 50
    - position icon, 38
    - posttrigger, 70, 72
    - pretrigger, 70, 72
    - Pulse Width, defined, 74
    - readout, 39, 80
    - Rise/Fall, defined, 75
    - RS-232 bus, 78
    - RS-232 data value
      - matching, 80
    - Runt, defined, 74
    - Sequence (B Trigger),
      - defined, 74
    - sequential, 81
    - serial buses, 54, 170
    - Setup and Hold, defined, 75
    - slope, 72
    - SPI bus, 77
    - status readout, 38
    - Trigger on B events, 82
    - USB bus, 78
    - video lines, 164
    - Video, defined, 76
  - Trigger menu, 31, 73, 81, 163
    - button, 73, 163
  - Trigger modes
    - Auto, 70
    - Normal, 70
  - Trigger types, defined, 74
  - Triggering on Buses, 76
- ## U
- UART, 32, 54
  - Undo
    - Autoset, 48
    - Default Setup, 48
  - Upgrading firmware, 20
  - USB, 54, 76, 134, 143
    - bus trigger, 78
    - device port, 43
    - flash drive, 25
    - host ports, 36, 43
  - USBTMC, 43
  - User interface language, 16
  - User marks, 124
  - Utility button, 16, 17, 19, 31, 85, 87, 96, 97, 144
  - Utility menu, 16, 18, 31, 36, 85, 97, 98
- ## V
- Variable persistence, 85
  - Ventilation, 7
  - Versatile Probe Interface, 8
  - Version, firmware, 23
- ## Vertical
- button, 32
  - menu, 32, 90
  - Menu knob, 35
  - offset, 93
  - Offset, 91
  - position, 89
  - position and autoset, 49
  - position and offset, 93
  - Position knob, 35, 45
  - scale, 89, 165
  - Scale knob, 35, 45
- ## Video
- Autoset, 49
  - fields, 163
  - lines, 164
  - port, 42
  - trigger, 163
- ## Video trigger, defined, 76
- ## View
- digital channels, 96
  - waveform record, 38
- ## VISA, 23
- ## W
- Wave Inspector, 122
  - Waveform
    - adding, 84
    - display style, 84
    - histogram measurements, 103
    - intensity, 88
    - pan, 122, 123
    - pause, 123
    - play, 123
    - play-pause, 123
    - record defined, 50
    - removing, 84
    - search and mark, 124
    - user marks, 124
    - zoom, 122
  - Waveform baseline indicator, 40
  - Waveform Count measurement, 103
  - Waveform record, 50
  - Waveform record view, 38
  - Weight, 5
  - White edges, 96
  - Width, 5
  - Word, 25



**X**

## XY

- cursors, 112
- display, 85

**Z**

## Zoom, 122

- button, 34
- graticule size, 123
- Horizontal, 167
- knob, 34, 122