

Agilent 4287A RF LCR Meter

Operation Manual

Twelfth Edition

FIRMWARE REVISIONS/SERIAL NUMBERS

This manual applies directly to instruments that have the firmware revision 2.0x and serial number prefix MY433.
For additional important information about firmware revisions and serial numbers, see Appendix A.



Agilent Part No. 04287-90024

August 2012

Notices

The information contained in this document is subject to change without notice.

This document contains proprietary information that is protected by copyright. All rights are reserved. No part of this document may be photocopied, reproduced, or translated to another language without the prior written consent of Agilent Technologies.

Microsoft®, MS-DOS®, Windows®, Visual C++®, Visual Basic®, VBA® and Excel® are registered

UNIX is a registered trademark in U.S. and other countries, licensed exclusively through X/Open Company Limited.

Portions ©Copyright 1996, Microsoft Corporation. All rights reserved.

© Copyright 2000, 2001, 2002, 2003, 2004, 2005, 2012 Agilent Technologies

Manual Printing History

The manual's printing date and part number indicate its current edition. The printing date changes when a new edition is printed. (Minor corrections and updates that are incorporated at reprint do not cause the date to change.) The manual part number changes when extensive technical changes are incorporated.

January 2000	Preliminary (part number: 04287-90000)
March 2000	First Edition (part number: 04287-90010)
April 2000	Second Edition (part number: 04287-90020)
May 2000	Third Edition (part number: 04287-90030)
July 2000	Fourth Edition (part number: 04287-90040)
January 2001	Fifth Edition (part number: 04287-90050)
December 2001	Sixth Edition (part number: 04287-90070)
February 2002	Seventh Edition (part number: 04287-90080)
November 2002	Eighth Edition (part number: 04287-90090)
May 2003	Ninth Edition (part number: 04287-90004)
December 2004	Tenth Edition (part number: 04287-90014)
December 2005	Eleventh Edition (part number: 04287-90024)
August 2012	Twelfth Edition (part number: 04287-90024)

Safety Summary

The following general safety precautions must be observed during all phases of operation, service, and repair of this instrument. Failure to comply with these precautions or with specific WARNINGS elsewhere in this manual may impair the protection provided by the equipment. Such noncompliance would also violate safety standards of design, manufacture, and intended use of the instrument. Agilent Technologies assumes no liability for the customer's failure to comply with these precautions.

NOTE

The 4287A complies with INSTALLATION CATEGORY II as well as POLLUTION DEGREE 2 in IEC61010-1. The 4287A is an INDOOR USE product.

NOTE

The LEDs in the 4287A are Class 1 in accordance with IEC60825-1, CLASS 1 LED PRODUCT

- **Ground the Instrument**

To avoid electric shock, the instrument chassis and cabinet must be grounded with the supplied power cable's grounding prong.
- **DO NOT Operate in an Explosive Atmosphere**

Do not operate the instrument in the presence of inflammable gasses or fumes. Operation of any electrical instrument in such an environment clearly constitutes a safety hazard.
- **Keep Away from Live Circuits**

Operators must not remove instrument covers. Component replacement and internal adjustments must be made by qualified maintenance personnel. Do not replace components with the power cable connected. Under certain conditions, dangerous voltage levels may exist even with the power cable removed. To avoid injuries, always disconnect the power and discharge circuits before touching them.
- **DO NOT Service or Adjust Alone**

Do not attempt internal service or adjustment unless another person, capable of rendering first aid and resuscitation, is present.
- **DO NOT Substitute Parts or Modify the Instrument**

To avoid the danger of introducing additional hazards, do not install substitute parts or perform unauthorized modifications to the instrument. Return the instrument to an Agilent Technologies Sales and Service Office for service and repair to ensure that safety features are maintained in operational condition.
- **Dangerous Procedure Warnings**

Warnings, such as the example below, precede potentially dangerous procedures throughout this manual. Instructions contained in the warnings must be followed.

WARNING

Dangerous voltage levels, capable of causing death, are present in this instrument. Use extreme caution when handling, testing, and adjusting this instrument.

Safety Symbols

General definitions of safety symbols used on the instrument or in manuals are listed below.



Instruction Manual symbol: the product is marked with this symbol when it is necessary for the user to refer to the instrument manual.



Alternating current.



Direct current.



On (Supply).



Off (Supply).



In-position of push-button switch.



Out-position of push-button switch.

A chassis terminal; a connection to the instrument's chassis, which includes all exposed metal structure.



Stand-by.

WARNING

This warning sign denotes a hazard. It calls attention to a procedure, practice, or condition that, if not correctly performed or adhered to, could result in injury or death to personnel.

CAUTION

This Caution sign denotes a hazard. It calls attention to a procedure, practice, or condition that, if not correctly performed or adhered to, could result in damage to or destruction of part or all of the instrument.

NOTE

This Note sign denotes important information. It calls attention to a procedure, practice, or condition that is essential for the user to understand.

Certification

Agilent Technologies certifies that this product met its published specifications at the time of shipment from the factory. Agilent Technologies further certifies that its calibration measurements are traceable to the United States National Institute of Standards and Technology, to the extent allowed by the Institution's calibration facility or by the calibration facilities of other International Standards Organization members.

Warranty

This Agilent Technologies instrument product is warranted against defects in material and workmanship for a period corresponding to the individual warranty periods of its component products. Instruments are warranted for a period of one year. Fixtures and adapters are warranted for a period of 90 days. During the warranty period, Agilent Technologies will, at its option, either repair or replace products that prove to be defective.

For warranty service or repair, this product must be returned to a service facility designated by Agilent Technologies. Buyer shall prepay shipping charges to Agilent Technologies, and Agilent Technologies shall pay shipping charges to return the product to Buyer. However, Buyer shall pay all shipping charges, duties, and taxes for products returned to Agilent Technologies from another country.

Agilent Technologies warrants that its software and firmware designated by Agilent Technologies for use with an instrument will execute its programming instruction when properly installed on that instrument. Agilent Technologies does not warrant that the operation of the instrument, or software, or firmware will be uninterrupted or error free.

Limitation of Warranty

The foregoing warranty shall not apply to defects resulting from improper or inadequate maintenance by Buyer, Buyer-supplied software or interfacing, unauthorized modification or misuse, operation outside the environmental specifications for the product, or improper site preparation or maintenance.

IMPORTANT

No other warranty is expressed or implied. Agilent Technologies specifically disclaims the implied warranties of merchantability and fitness for a particular purpose.

Exclusive Remedies

The remedies provided herein are Buyer's sole and exclusive remedies. Agilent Technologies shall not be liable for any direct, indirect, special, incidental, or consequential damages, whether based on contract, tort, or any other legal theory.

Assistance

Product maintenance agreements and other customer assistance agreements are available for Agilent Technologies products.

For any assistance, contact your nearest Agilent Technologies Sales and Service Office. Addresses are provided at the back of this manual.

Typeface Conventions

Bold	Boldface type is used when a term is defined. For example: icons are symbols.
<i>Italic</i>	Italic type is used for emphasis and for titles of manuals and other publications.
[Hardkey]	Indicates a hardkey labeled “Hardkey.”
Softkey	Indicates a softkey labeled “Softkey.”
[Hardkey] - Softkey1 - Softkey2	Indicates keystroke sequence [Hardkey] - Softkey1 - Softkey2 .

4287A Documentation Map

The following manuals are available for the 4287A.

- ***Operation Manual (P/N: 04287-900x4)***

Most of the basic information necessary for using the 4287A is provided in this manual. It describes installation, preparation, measurement operation including calibration, performances (specifications), and error messages. For GPIB programming, see the *Programming Manual*.

- ***Programming Manual (P/N: 04287-900x1)***

The *Programming Manual* shows how to write and use BASIC program to control the 4287A.

Software Installed

The Windows operating system installed in this machine is customized for more effective operation, and has different functions that are not part of the Windows operating system for ordinary PCs (personal computers). Therefore, do not attempt to use the system in ways other than those described in this manual or to install Windows-based software (including anti-virus software) for ordinary PCs as doing so may cause malfunctions.

Also note the followings.

- Do not update the Windows operating system installed in this machine to the Windows operating system for ordinary PCs. Doing so will cause malfunctions.
- Do not allow any computer virus to infect the system. This machine has no virus check function nor anti-virus software installed.

Agilent Technologies will not be held liable for any failure or damage arising from negligence regarding these prohibitions and warnings.

NOTE

If the pre-installed software is damaged somehow, resulting in errant behavior by the machine, perform a "system recovery".

1. How to Use This Operation Manual	
Relationship of Operation Manual Contents to the Handling of the 4287A	16
2. Installation Guide	
Incoming Inspection	18
Environmental Requirements	20
Operation environment	20
Ventilation space at installation site	20
Ensure free space is available around unit to allow speedy disconnection of power cable in case of emergency	21
How to Install Front Handles/Rack Mounting Flanges	22
How to install handle kit (Option 1CN)	22
How to install rackmount kit (Option 1CM)	24
How to install rack-mount and handle kit (Option 1CP)	26
Connecting Mouse and Keyboard	29
LAN Connection	30
Connecting the Test Head	31
Connecting the DUT when using a special test fixture	31
When using with the test head fixed on a handler, etc.	33
Caution for connecting the SMA connector to the test head connector	34
Preparation for Power Supply	35
Check the power supply	35
Verification and connection of power cable	35
Blown fuse.	37
Turning the Power ON and OFF	38
Turning the power ON	38
Turning the power OFF	38
Disconnection from Supply Source	39
Initial Registration of 4287A	40
Setting the Internal Clock	43
Setting the Date/Time	43
Turning the Date/Time Display ON and OFF	44
Selection of Test Fixture	45
About connection of test fixture and DUT	46
Instructions for Cleaning	46
Precautions Required When Connecting the 4287A to Automatic Equipment (Handler), etc.	47
3. Learning Basic Operations	
What You Must Keep on Hand	50
Preparation for Measurement	52
Connection between test head and fixture stand	52
Turning ON the power	53
How to Set Measuring Conditions	54
Presetting the 4287A	54
How to set the measurement point (frequency/averaging factor/oscillator level)	54
Calibration and Compensation	57
Setting with the calibration and compensation wizard	57
Executing short calibration	58

Executing open calibration	61
Executing low-loss capacitor calibration	62
Executing load calibration	63
Connection of Test Fixture	65
Executing short compensation	66
Executing open compensation	67
Display of DUT Connection and Measurement Result	69
DUT connection and measurement.	69
How to change measurement point.	69
How to change measurement parameters	70
Measurement and display of all set measurement points (list measurement).	71

4. Function Overview

Names and Functions of Parts on the Front Panel	74
1. Stand-by switch ()	74
2. Built-in 3.5-inch floppy disk drive	74
3. Color LCD display	75
4. Navigation block (NAVIGATION).	75
5. Measurement block (MEASUREMENT).	75
6. Instrument state block (INSTR STATE).	76
7. Entry block (ENTRY).	76
8. Test Head Interface (TEST HEAD INTERFACE).	77
Names and Functions of Parts on the Rear Panel.	79
1. Power cable receptacle (- LINE)	79
2. External trigger input terminal (Ext Trig).	79
3. External monitor output terminal (VIDEO)	80
4. LAN port.	80
5. GPIB connector.	80
6. Handler interface.	80
7. External reference signal input terminal (Ext Ref In, 10 MHz 0 dBm)	80
8. Internal reference signal output terminal (Int Ref Out)	80
9. Mouse port (MOUSE)	80
10. Mini-DIN keyboard port (KYBD)	81
11. Serial number plate	81
12. Option plate.	81
13. Reserved ports (Reserved)	81
Names and Functions of Display Areas on the LCD Display	82
Single point measurement display	84
List measurement display	89
Measurement point setup display	91
Calibration kit setup display	93
Compensation kit setup display	95
Bin sorting setup display	97
4287A Key Operation Overview	99

5. Setting Measurement Conditions

How to Preset the 4287A	102
-----------------------------------	-----

How to Set the Measurement Point	103
How to bring up the measurement point setup display	103
How to specify table number for setup	104
How to add measurement points	105
How to change frequency of a set measurement point	108
How to change averaging factor	109
How to change oscillator level	110
How to change oscillator level setup unit	111
Setting up dc resistance (Rdc) measurement	113
Turning ON/OFF	113
Turning ON/OFF offset cancel function	113
6. Calibration and Compensation	
Calibration and Compensation Functions	116
Types of calibration and compensation functions	116
Calibration reference plane and required calibration and compensation	117
Calibration and Compensation Procedures Using Dedicated Test Fixture	120
1. Test head coaxial terminal used as calibration reference plane	121
2. DUT connection terminal used as calibration reference plane	131
Calibration and Compensation Procedure without Using Dedicated Test Fixture	135
1. Test head coaxial terminal used as calibration reference plane	135
2. DUT connection terminal used as calibration reference plane	142
How to Define Calibration Kit	145
Calibration kit definition procedure	145
How to Define Compensation Kit	147
Compensation kit definition procedure	147
Registering the Electrical Length of Unregistered Test Fixtures	149
Preventing Mistakes During Execution of Calibration and Compensation	151
1. Setting the limit for DC resistance (Rdc)	151
2. How to execute calibration and compensation	152
7. Executing Measurements and Displaying Results	
Connecting the DUT	156
Selecting Single Point Measurement or List Measurement	157
How to Select the Measurement Point Table	158
Selection of Measurement Point	159
Selection of Measurement Parameters in Single Point Measurement Display	160
Selection of Display Parameters in List Measurement Display	162
Setting How the Instrument Displays Measurement Results (Enabling/Disabling Deviation Measurement Mode)	164
Hiding the Screen Display	166
Turning ON/OFF Update the LCD Display View	167
8. Sorting According to Measurement Results	
Overview of BIN Sort Function	172
Concept of setting 4287A BINs	174
Internal flow of BIN sort judgment	176
Setting Measurement Point	177

Setting Measurement Parameter	179
Setting Limit Mode and Reference Value	181
Setting limit mode	181
Setting reference value	182
Setting BIN Range	183
Setting upper limit value	183
Setting lower limit value	184
Selecting BIN range mode	185
Setting BIN On and Off	186
Setting Faulty BIN (OUT OF GOOD BINS)	187
Setting Upper and Lower Limit Values for DC Resistance Measurement	188
Turning On BIN Sorting and Displaying the Result	189
Bin Count Function	190
Turning on Bin Count	190
Listing the BIN Count results	190
Initializing the contents of the bin counts to zero (resetting the counter)	191
Example of Settings for BIN Sorting	192
Setting the measurement point number, measurement parameter, and BIN range setting mode for Condition 1	193
Setting the measurement point number, measurement parameter, and BIN range setting mode for Condition 2	196
Setting the measurement value range for sorting into BIN 1 to BIN 3	197
OUT OF GOOD BINS setting	202
Displaying the BIN sorting results	204
9. Obtaining Statistical Data on Measurement Results	
Overview of Functions for Statistical Analysis	206
Data Logging for Statistical Analysis	207
Executing Statistical Analysis and Displaying Results	209
Saving Measurement Data for Statistical Analysis	210
10. Storing and Retrieving 4287A Internal Information and File Management	
Saving Setting Status	214
Entering the Filename using the Mouse	215
Saving Screen Displays	216
Saving the List Measurement Display in CSV Format	217
Example of the Saved List Measurement Display Data (CSV format)	218
Saving the Setup Table (Measurement point, Calibration kit, Compensation kit) in CSV Format	219
Example of the Saved Setup Table Data (CSV format)	220
Saving the BIN Sorting Setup Table in CSV Format	221
Example of the Saved BIN Sorting Setup Table Data (CSV format)	222
11. Setting and Using the Control and Management Facilities	
Checking and Editing the GPIB Address	226
Configuring the Network	228
Enabling/disabling network	228
Setting IP address	229
Specifying computer name	231

Setting the Built-in Speaker (Beep Sound)	233
Turning the completion beep ON or OFF	233
Turning the warning beep ON or OFF	233
Switching the beep sound that indicates the BIN sort function result (Pass or Fail)	234
Locking the Front Panel Keys, Keyboard and Mouse	235
Locking the front panel keys and keyboard	235
Locking the keyboard	236
Locking the mouse	237
Locking the front panel keys, keyboard and mouse simultaneously.	238
Turning OFF the LCD Display's Backlight	239
System Recovery	240
Types of system recoveries	240
Notes on executing system recovery	240
Procedure to execute system recovery	241
Procedure to create the user backup image	244
Procedure to execute the user recovery function	247
12. Specifications and Supplemental Performance Characteristics	
Basic Measurement Characteristics	253
Measurement parameters.	253
Measurement range	253
Source characteristics	253
Measurement accuracy	255
Timing chart and measurement time (SPC)	261
Measurement Support Functions	270
Error correction function.	270
DC resistance (Rdc) measurement	270
Trigger function.	271
Averaging function	271
Display	271
List measurement function	271
Test signal level monitor function.	271
Mass Storage	271
Interface.	271
Measurement terminal (at Test Head)	273
Rear panel connectors	273
General Characteristics.	275
Environment conditions	275
Furnished accessories	280
Option 004 Working Standard Set Characteristics	281
Furnished devices	281
DC resistance.	281
A. Manual Changes	
Manual Changes	284
Change 7	285
Change 6	285
Change 5	287

Change 4	288
Miscellaneous Changes.	291
Change 3	293
Change 2	293
Change 1	293
B. Differences from Agilent 4286A	
1. Main Differences Between 4286A and 4287A.	296
Outline of Differences in Calibration/Compensation	296
Outline of Differences in Comparator Handler I/F.	297
Other Important Differences	297
2. Differences Between 4286A and 4287A Hardware	298
3. Functional Differences Between 4286A and 4287A	301
C. Improvement of Measurement Throughput by Screen Display Settings	
How to improve 4287A measurement throughput by screen display settings	310
Hiding the Screen Display	310
Optimizing the Settings of the Display Contents	310
D. Table of Operations When Measurement Errors Occur	
Operations When Measurement Errors Occur	312
E. Printing Out Measurement Results and Internal Data on a Printer	
Printer Support	314
Printer Support	315
Procedure for Printing	316
1. Selecting the contents to be printed	316
2. Setting the image format.	316
3. Setting paper orientation.	317
4. Selecting the printer model.	317
5. Starting and stopping printing.	318
F. Error Messages	
Order of Error Number.	320
G. Information on Maintenance	
Cleaning this Instrument.	330
Cleaning an LCD	330
Maintenance of Connectors/Ports.	330
Cleaning a Display Other than an LCD	332
Cautions Applicable to Requesting Repair, Replacement, Regular Calibration, etc.	333
Devices to be Sent Back for Repair or Regular Calibration.	333
Recommended Calibration Period	333

1 **How to Use This Operation Manual**

This chapter explains how to most efficiently use this Operation Manual.

Relationship of Operation Manual Contents to the Handling of the 4287A

The chapters of this Operation Manual cover the usage flow from when the product is delivered until when the user has obtained sufficient understanding of the instrument's functions to use it efficiently.

Table 1-1 Relationship of Operation Manual Contents to Handling the 4287A

Handling of 4287A	Corresponding Chapter in Operation Manual
1. Installation	Chapter 2 "Installation Guide" on page 17
2. Understanding functions	Chapter 3 "Learning Basic Operations" on page 49 Chapter 4 "Function Overview" on page 73 ^{*1}
3. Performing measurements (manual operation)	Chapter 5 "Setting Measurement Conditions" on page 101 Chapter 6 "Calibration and Compensation" on page 115 Chapter 7 "Executing Measurements and Displaying Results" on page 155
4. Using analysis functions (manual operation)	Chapter 8 "Sorting According to Measurement Results" on page 171 Chapter 9 "Obtaining Statistical Data on Measurement Results" on page 205 Chapter 10 "Storing and Retrieving 4287A Internal Information and File Management" on page 213
5. Using control and management facilities (manual operation)	Chapter 11 "Setting and Using the Control and Management Facilities" on page 225
6. Development of automatic measurement system	(this entire manual and the <i>Programming Manual</i>)

*1. If you need more detailed information, please refer to Chapter 12, "Specifications and Supplemental Performance Characteristics," on page 251.

2 Installation Guide

This chapter describes procedures for preparing the Agilent 4287A RF LCR meter for use after it is delivered. It also describes daily maintenance procedures.

Incoming Inspection

WARNING

To avoid hazardous electrical shock, do not turn the power on if there are any signs of shipping damage to any part of the exterior (for example, damage on the top cover, bottom cover, side covers, front panel, rear panel, LCD display, connectors or line switch).

Inspect the equipment by following these steps while unpacking the contents of the shipping container.

Step 1. Check whether the shipping container or cushioning material is damaged.

If there is damage, save the shipping container and cushioning material as they are until you have made sure that all contents (main unit and accessories) are included and you have checked for mechanical and electrical defects.

Step 2. Use the checklist in Table 2-1 to ensure that all of the contents required for your specified options have been packed in the shipping container.

Table 2-1 Checklist of Agilent 4287A contents in shipping container

Order Model or Option Number	Agilent Part Number	Description	Qty	Check (✓)
Agilent 4287A	-	Agilent 4287A RF LCR Meter (Main Unit)	1	
	-	Test Head (with 1 m cable)	1	
	1250-2879	N(m)-SMA(f) Adapter	3	
	8710-2409	Wrench (for 3.5-mm/SMA connector)	1	
	04287-905xx	CD-ROM (<i>Operation Manual, Programming Manual, Sample Program</i>)* ¹	1	
	E2078-62101	GPIB adapter* ²	1	
	-	Power Cable	1	
Option 700	-	Agilent 16195B 7-mm Calibration Kit	1	
Option 710	-	Test Fixture Stand	1	
Option 720	1250-1746	3.5-mm-to-7-mm Coaxial Adapter	1	
Option 810	-	Keyboard	1	
Option 820	-	Mouse	1	
Option ABA	04287-900x0	<i>Operation Manual</i> * ¹	1	
	04287-900x1	<i>Programming Manual</i> * ¹	1	
	04287-180x0	Sample Program Disk (3.5 inch floppy disk)* ¹	1	

Table 2-1 Checklist of Agilent 4287A contents in shipping container

Order Model or Option Number	Agilent Part Number	Description	Qty	Check (√)
Option 004	16197-29001	Short device 0.6 × 0.3 mm	2	
	16191-29005	Short device 1.0 × 0.5 mm	2	
	16191-29006	Short device 1.6 × 0.8 mm	2	
	16191-29007	Short device 2.0 × 1.25 mm	2	
	16191-29008	Short device 3.2 × 1.6 mm	2	
	0699-6926	Resistor 0.6 × 0.3 mm	5	
	5182-0433	Resistor 1.0 × 0.5 mm	5	
	5182-0434	Resistor 1.6 × 0.8 mm	5	
	5182-0435	Resistor 2.0 × 1.25 mm	5	
	5182-0436	Resistor 3.2 × 1.6 mm	5	
Option 020	-	Test Head Extension Cable (1 m)	1	
	1250-1158	SMA(f)–SMA(f) Adapter	3	
Option 1CM	5063-9216	Rackmount Kit	1	
Option 1CN	5063-9229	Handle Kit	1	
Option 1CP	5188-4430	Rackmount & Handle Kit	1	

*1. The number indicated by “x” in the part number of each manual or sample program disk, 0 for the first edition, is incremented by 1 each time a revision is made. The latest edition comes with the product.

*2. Use this adapter when to connect a GPIB cable to 4287A GPIB connector.

Step 3. Make sure that the contents (main unit and accessories) are free of any mechanical or electrical defect.

Step 4. If you find any of the following in your inspection, contact your nearest Agilent Technologies office or sales representative:

1. The equipment packaging and cushioning material are damaged, or there is evidence that excessive force was applied to the container
2. Something is missing from the contents of the shipping container
3. A mechanical or electrical defect is found
4. Failure occurs during verification of equipment operation

In the case of 1, contact the forwarding agent of the equipment as well as your nearest Agilent Technologies office or sales representative. For subsequent inspection by the forwarding agent, the equipment, the shipping container, cushioning material, and contents must be kept as they are.

WARNING

To avoid hazardous electrical shock, do not turn the power on if there are any signs of shipping damage to any part of the exterior (for example, damage on the top cover, bottom cover, side covers, front panel, rear panel, LCD display, connectors or line switch).

Environmental Requirements

Ensure that the following environmental requirements are met before using this equipment.

Operation environment

Use the equipment in the following environment:

	Environmental requirements
Temperature	5 °C to 40 °C
Relative humidity	20 % to 80 %, wet bulb temperature ≤ 29 °C (disk drive ^{*1} operating condition) 15 % to 90 %, wet bulb temperature ≤ 29 °C (disk drive ^{*1} non-operating condition)
Altitude	0 to 2,000 m (0 to 6,561 feet)

*1. Built-in floppy disk

NOTE

Do not use the equipment in environments where condensation may occur.

For the environmental requirements of the equipment's storage, see "Environment conditions" on page 275.

Ventilation space at installation site

To ensure the specifications and measurement accuracy of the product, you must keep ambient temperature around the product within the specified range by providing appropriate cooling clearance around the product or, for the rackmount type, by forcefully air-cooling inside the rack housing. For information on ambient temperature to satisfy the specifications and measurement accuracy of the product, refer to "Measurement accuracy" on page 255 in Chapter 12, "Specifications and Supplemental Performance Characteristics."

When the ambient temperature around the product is kept within the temperature range of the operating environment specification (refer to "Operating Condition" on page 275), the product conforms to the requirements of the safety standard. Furthermore, under that temperature environment, it has been confirmed that the product still conforms to the requirements of the safety standard when it is enclosed with cooling clearance as follows:

	Requirements
Back	≥ 180 mm
Sides	≥ 60 mm (both right and left)

Figure 2-1 Ventilation space at installation site

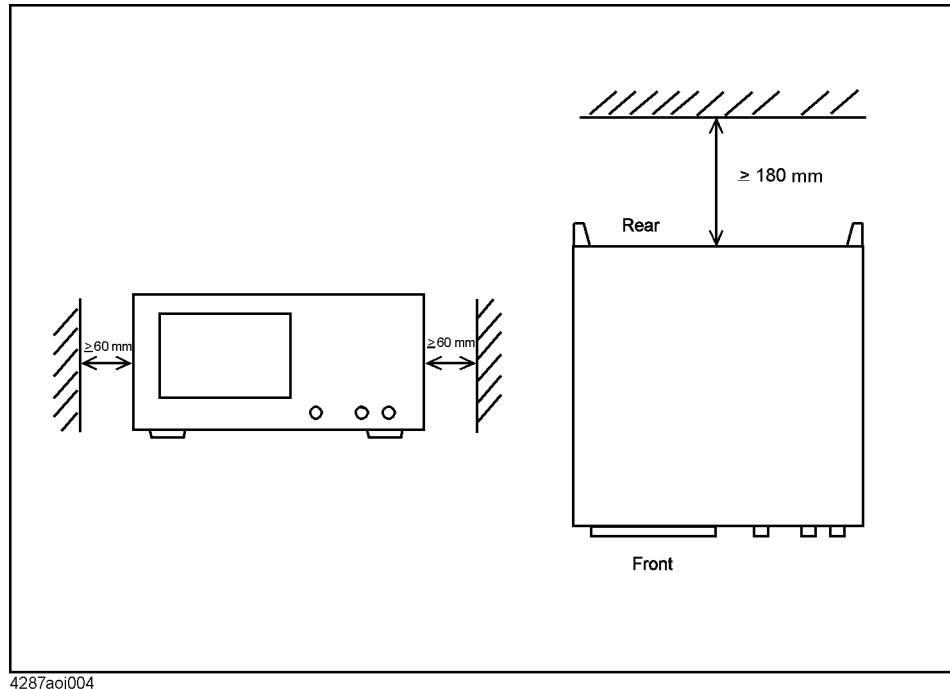

4287aoj004

Ensure free space is available around unit to allow speedy disconnection of power cable in case of emergency

As described in “Disconnection from Supply Source” on page 39, the disconnecting device of the 4287A is the plug or the connector of the power cable. When installing the 4287A, ensure that there is sufficient free space around the unit to allow the plug or the connector of the power cable (AC outlet side or 4287A side) to be quickly pulled out to disconnect the power supply in case of emergency.

How to Install Front Handles/Rack Mounting Flanges

The Agilent 4287A can be made more convenient for use with two key options: handles mounted on each side of the front for easy transport and flanges to attach the instrument to a rack as part of a multi-component measurement system (Table 2-2).

Table 2-2 Agilent 4287A rack mounting options

Name	Agilent Part Number	Description
Option 1CN handle kit	5063-9229	Two front handles used for transport and relocation of the Agilent 4287A
Option 1CM rack-mount kit	5063-9216	Two flanges (locking side plates) for mounting the Agilent 4287A on a rack (482.6 mm wide) conforming to EIA Standard
Option 1CN rack-mount kit and handle kit	5188-4430	Both the rack mounting flanges (locking side plates) and handles

How to install handle kit (Option 1CN)

Install the handle kit by following these steps:

- Step 1.** Make sure that all of the contents of the Option 1CN handle kit have been supplied in the shipping container (Table 2-3).

Table 2-3 Contents of Option 1CN handle kit

Name	Quantity
Front handle	2
Screw	6
Trim strip	2

- Step 2.** Remove the trim strips from both sides of the outer frame of the Agilent 4287A front panel.

Figure 2-2 How to remove trim strips from sides

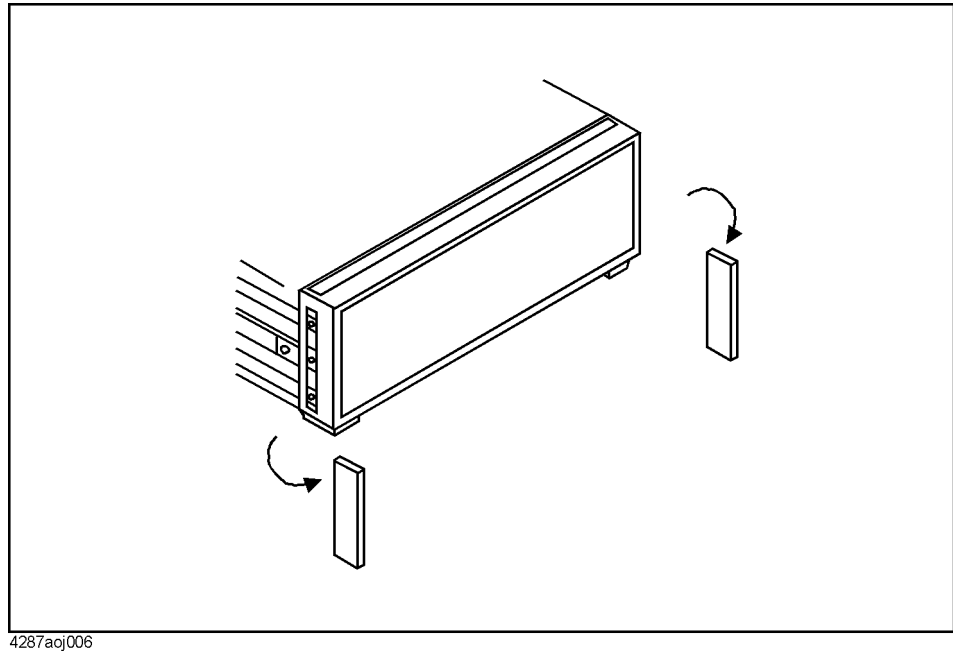

Step 3. Use the included screws to mount the two handles on the sides of the Agilent 4287A front panel frame.

Figure 2-3 How to install handles on front panel

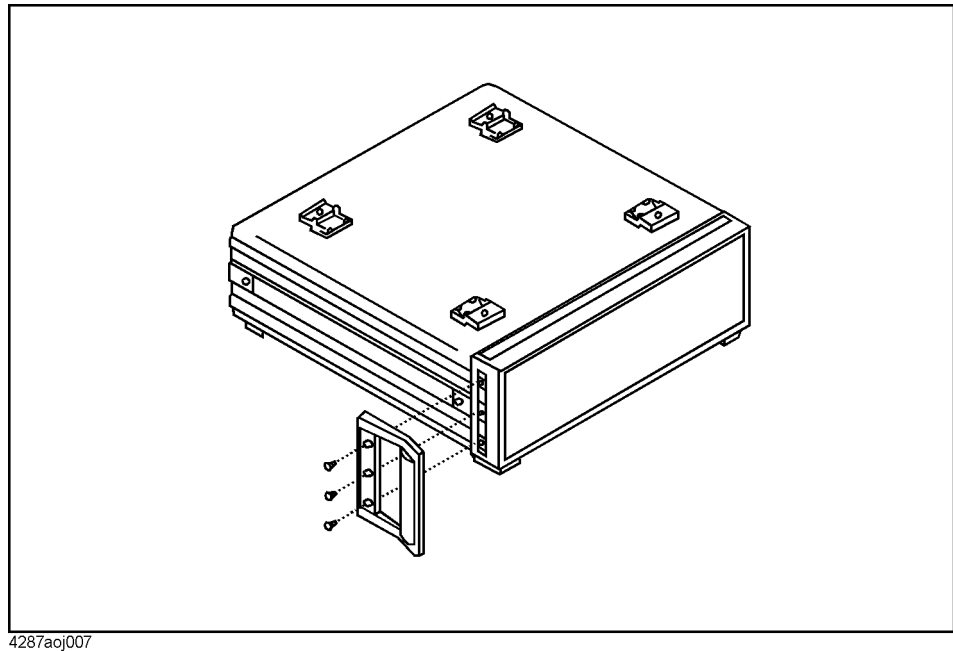

Step 4. Attach the included modified trim strip in order to cover the front panel locking screws.

Figure 2-4 How to install modified trim strip

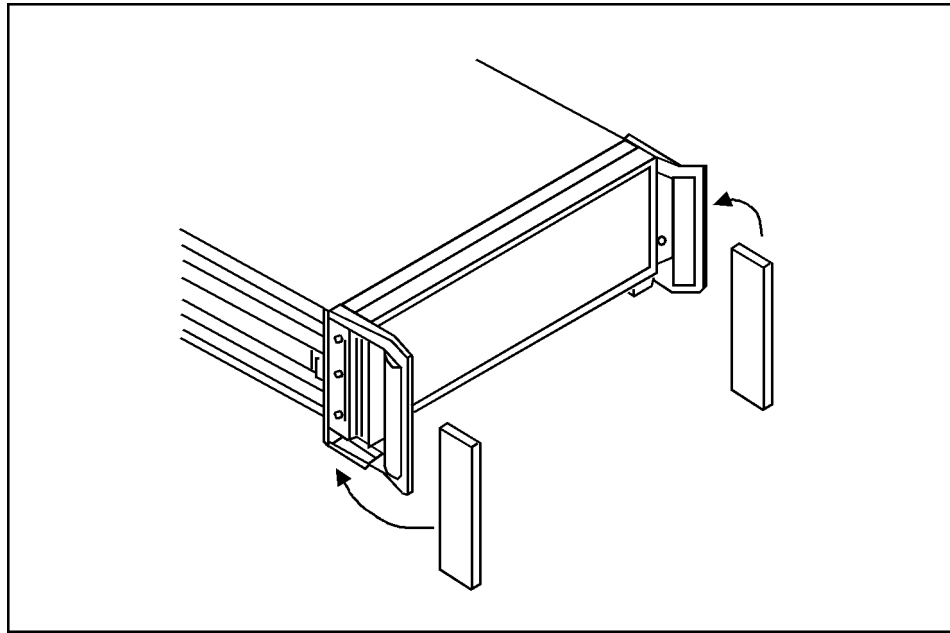

WARNING

If the installed front handle becomes damaged, replace it with a new one immediately. A damaged handle can break while moving or lifting the instrument and cause personal injury or damage to the instrument.

How to install rackmount kit (Option 1CM)

Install the rackmount kit by following these steps:

- Step 1.** Make sure that all of the contents of the rackmount kit (Option 1CM) have been supplied in the shipping container (Table 2-4).

Table 2-4

Contents of rack-mount kit (Option 1CM)

Name	Quantity
Rackmounting flange (locking side plate)	2
Screw	6

- Step 2.** Remove the trim strips from both sides of the outer frame of the Agilent 4287A front panel.

Figure 2-5 How to remove trim strips from sides

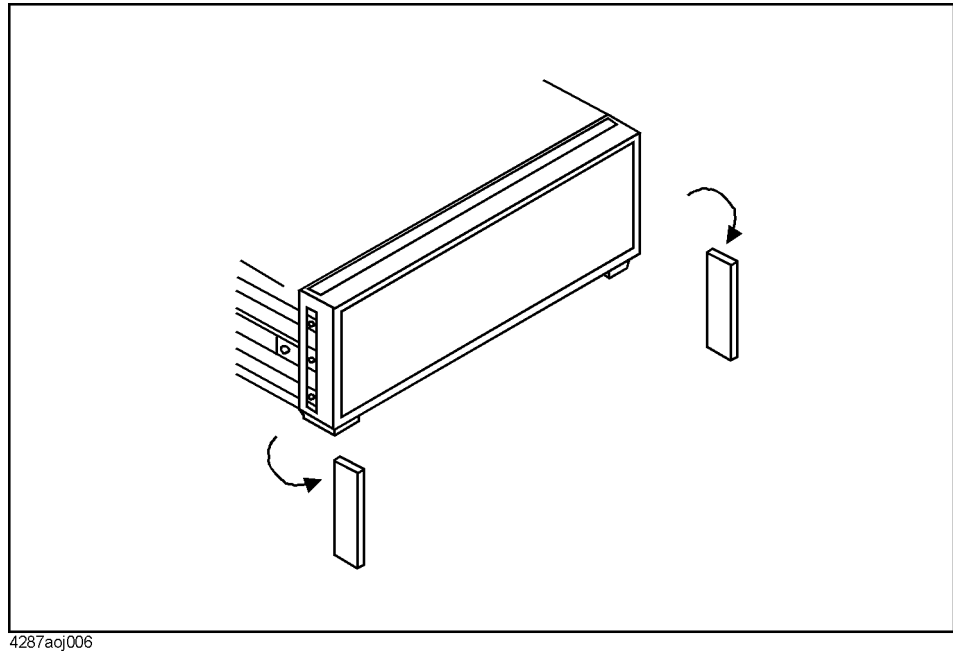

Step 3. Use the included screws to mount the two rack-mounting flanges (locking side plates) on the sides of the Agilent 4287A front panel frame.

Figure 2-6 How to install rack-mounting flanges (locking side plates) on front panel

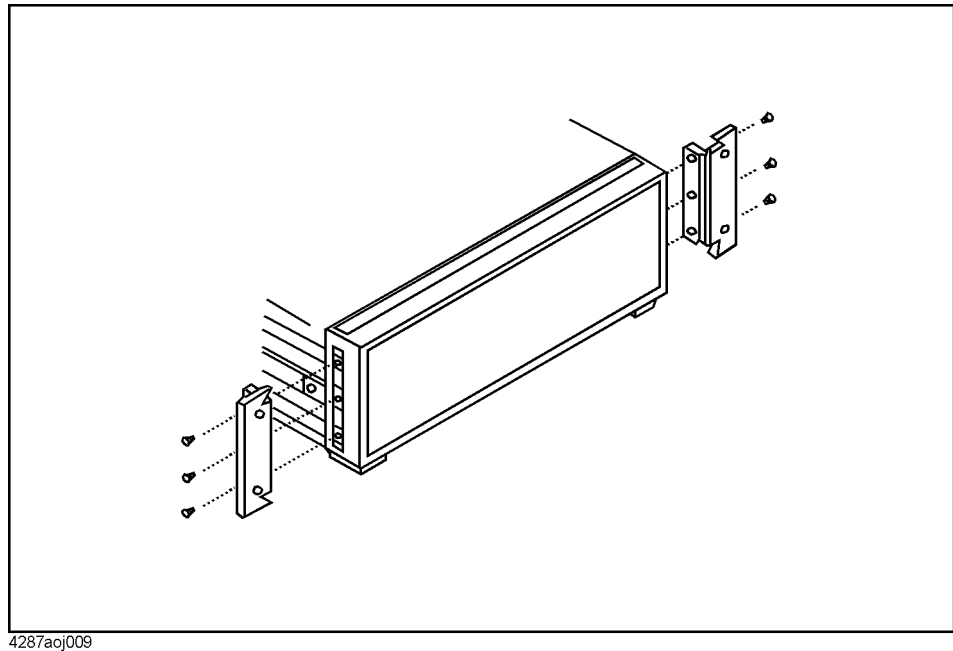

Step 4. Remove the four bottom feet and two tilt stands.

NOTE Do not detach the four feet from the rear panel.

Figure 2-7

How to remove bottom feet and tilt stands

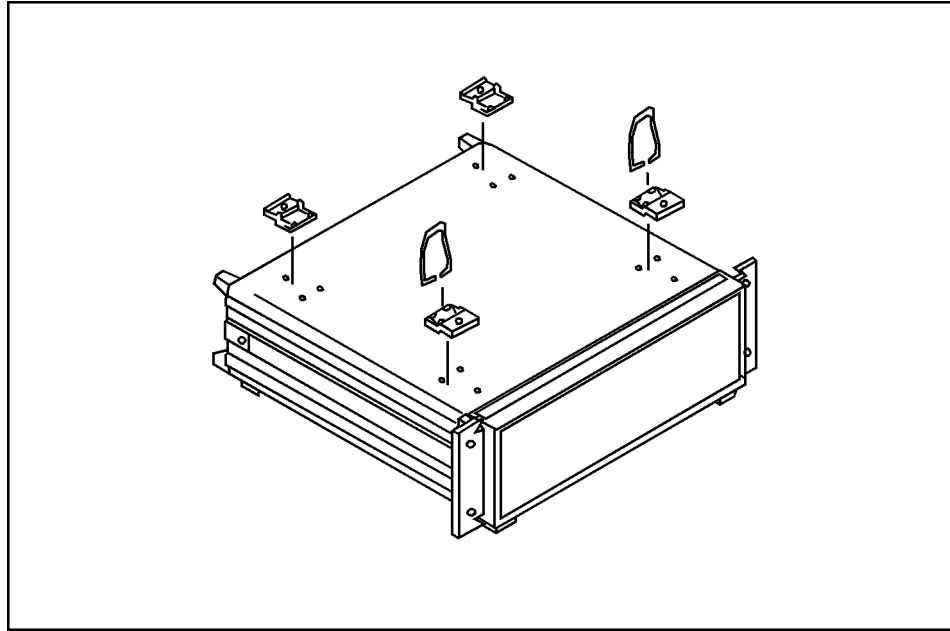

4287aoj010

Step 5. Mount the Agilent 4287A on the rack.

How to install rack-mount and handle kit (Option 1CP)

Install both the rack-mounting flanges and front handles by following these steps:

Step 1. Make sure that all of the contents of the rack-mount and handle kit (Option 1CM) have been supplied in the shipping container (Table 2-5).

Table 2-5

Contents of rack-mount and handle kit (Option 1CP)

Name	Quantity
Rack-mounting flange (locking side plate)	2
Front handle	2
Screw	8

Step 2. Remove the trim strips from both sides of the outer frame of the Agilent 4287A front panel.

Figure 2-8 How to remove trim strips from sides

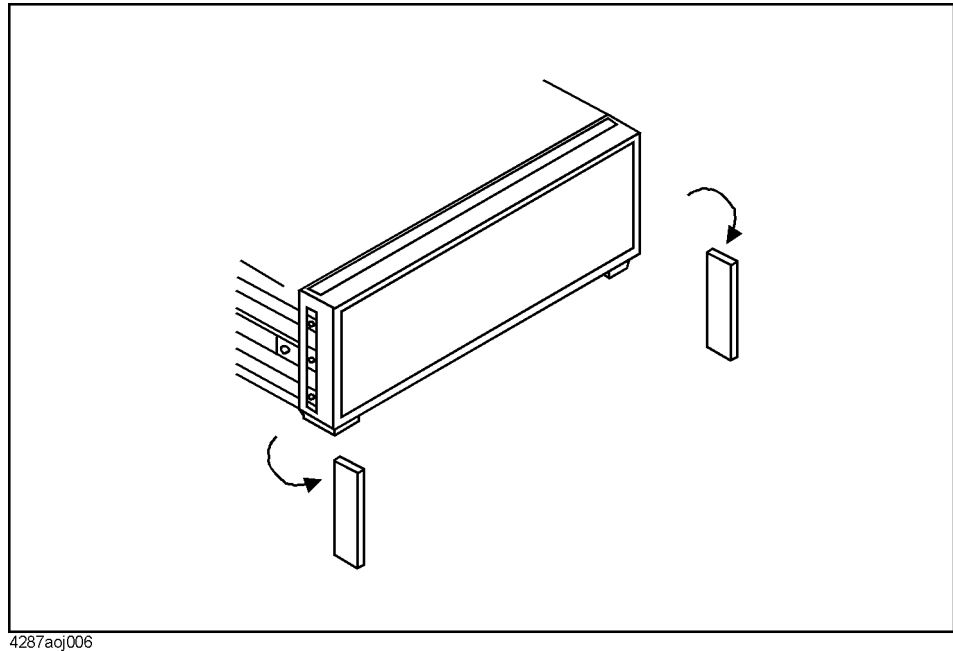

Step 3. Use the included screws to install the front handles and rack-mounting flanges on the sides of the Agilent 4287A front panel frame.

Figure 2-9 How to install front handles and rack-mounting flanges

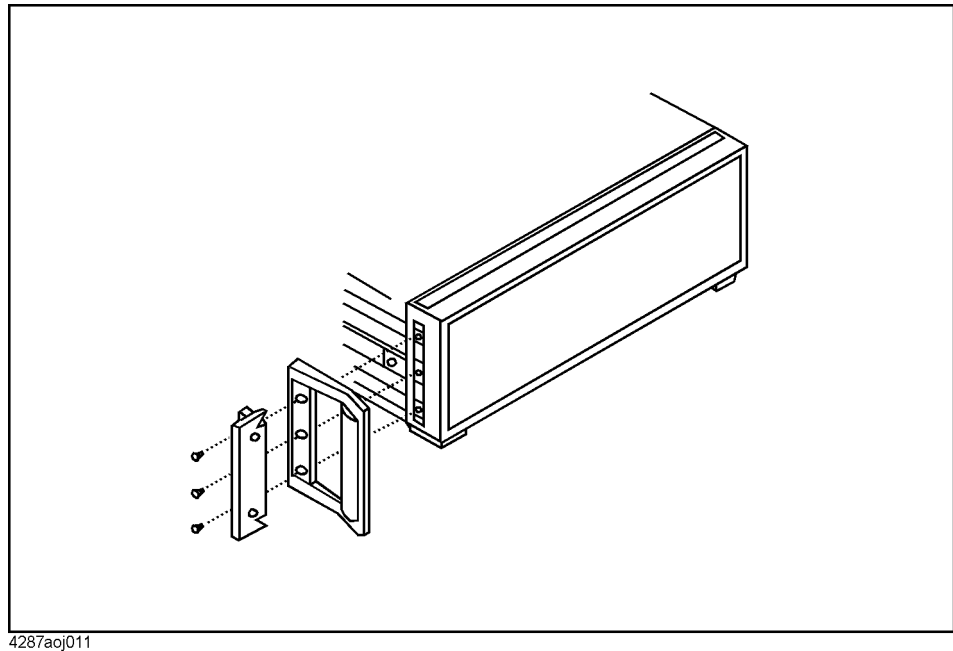

Step 4. Remove the four bottom feet and two tilt stands.

NOTE Do not detach the four feet from the rear panel.

Figure 2-10 How to remove bottom feet and tilt stands

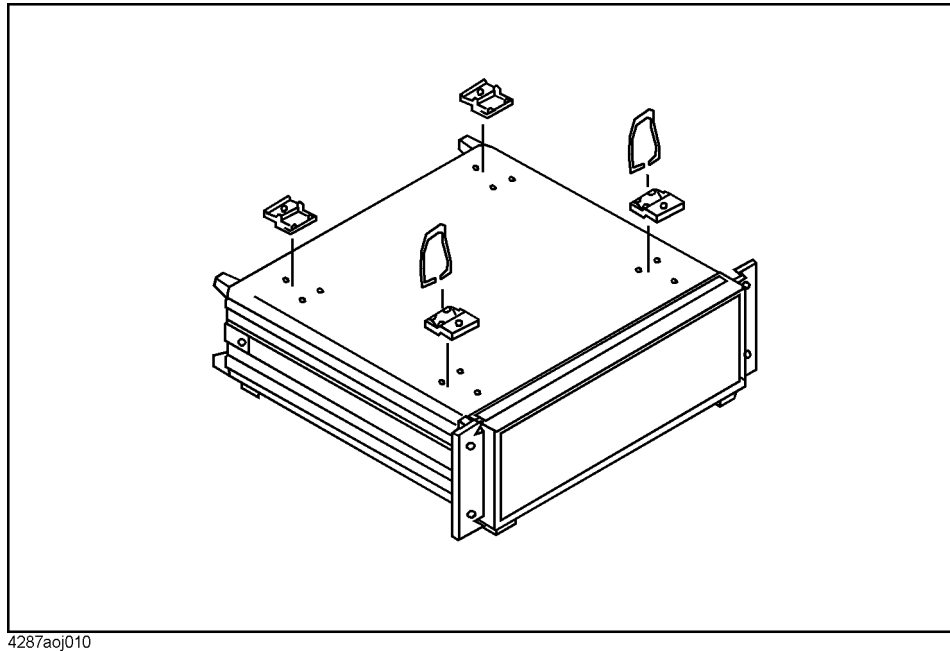

4287aoj010

Step 5. Mount the Agilent 4287A on the rack.

WARNING

If the installed front handle becomes damaged, replace it with a new one immediately. A damaged handle can break while moving or lifting the instrument and cause personal injury or damage to the instrument.

Connecting Mouse and Keyboard

Connect the mouse and keyboard to the designated ports shown in Figure 2-11.

Figure 2-11

Connections of mouse and keyboard

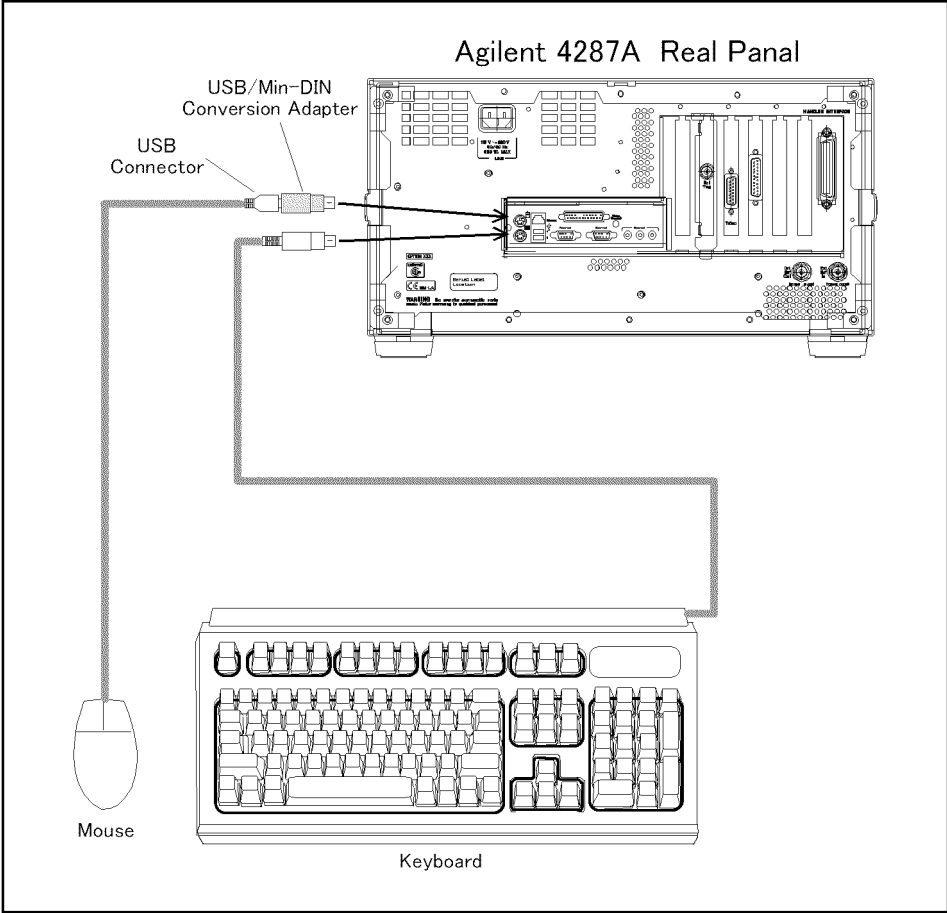

4287a0e10001

LAN Connection

- Step 1.** Make the appropriate settings on the 4287A for connecting to a Local Area Network (LAN) according to “Configuring the Network” on page 228.
- Step 2.** Connect the Agilent 4287A to the LAN according to Figure 2-12.

NOTE

Before connecting to the LAN, be sure to perform the correct LAN settings on the 4287A. If the appropriate LAN settings are not made, damage to the network could occur when connecting to the LAN.

Figure 2-12 LAN Connection

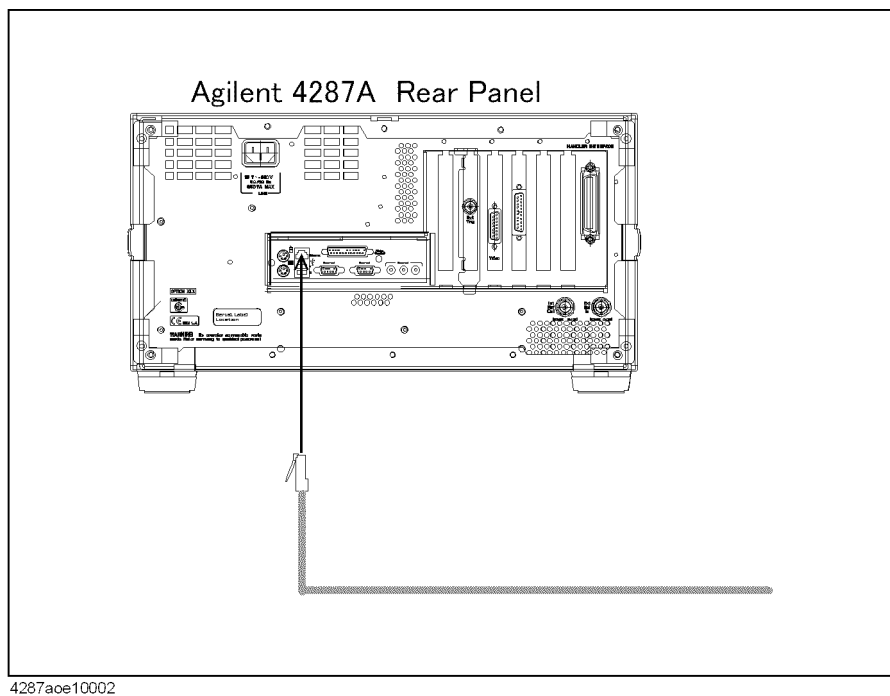

Connecting the Test Head

Connecting the DUT when using a special test fixture

When taking measurements while using special test fixtures with 7-mm terminals like the Agilent 16196A, follow these steps to connect the test head, test fixture stand, and 3.5-mm-to-7-mm adapter.

Figure 2-13

Connecting test head to test fixture stand

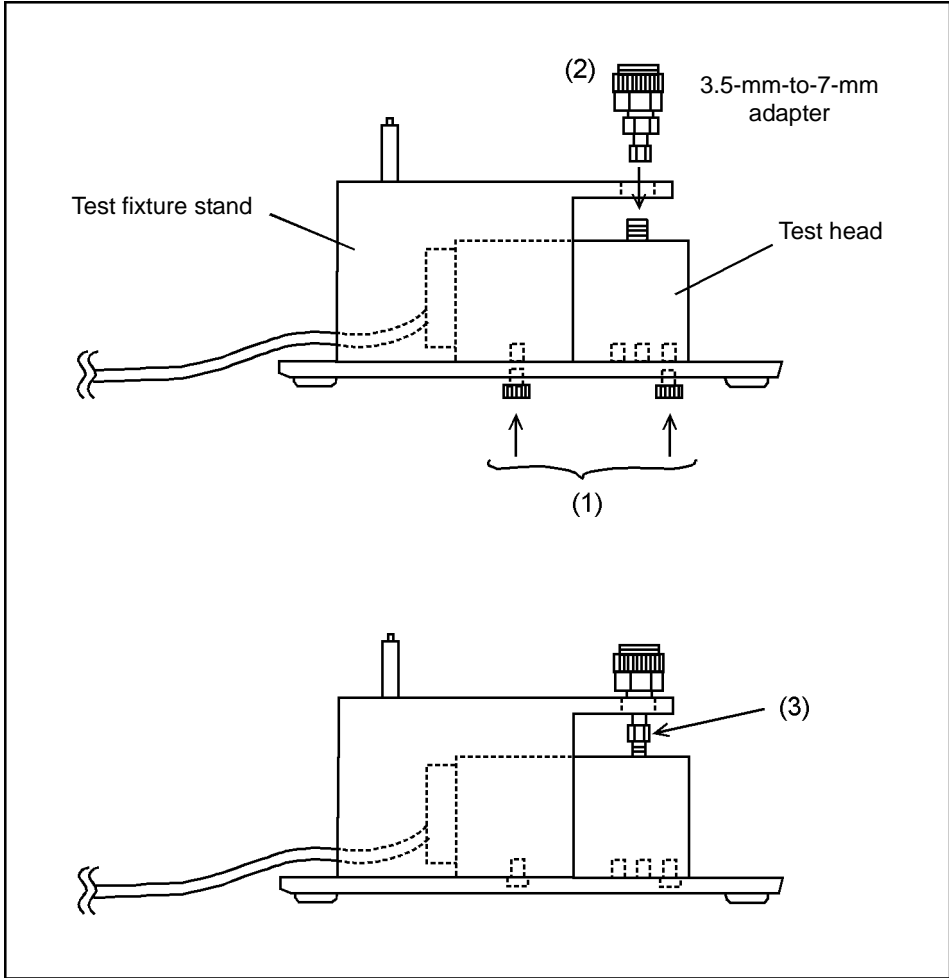

4287aoj050

- Step 1.** As shown in Figure 2-13 (1), attach the test head to the test fixture stand with two screws. At this point, do not tighten the screws completely (there should be some play).
- Step 2.** As shown in Figure 2-13 (2), align the 3.5-mm-to-7-mm adapter with the hole in the test fixture stand and gently insert the adapter.
- Step 3.** As shown in Figure 2-13 (3), tighten the connector nut of the 3.5-mm connector with the provided wrench (for 3.5 mm/SMA connector).

NOTE Be sure to use the provided wrench (for 3.5 mm/SMA connector) when tightening the connector nut of the 3.5-mm connector. Using another wrench could result in damage to the connector, which would cause incorrect measurements in the future.

Step 4. Firmly tighten the two screws shown in Figure 2-13 (1).

Step 5. Attach the three N(m)-SMA(f) adapters to the RF OUT, PORT 1, and PORT 2 terminals of the 4287A test head interface.

Connect the three SMA(m) connectors (RF OUT, PORT 1, PORT 2) of the test head cable to the SMA(f) terminals of the adapters attached in Step 5. Then tighten each of the connectors using the provided wrench (for 3.5-mm/SMA connector) (Figure 2-14).

NOTE Be sure to use the provided wrench (for 3.5 mm/SMA connector) when tightening the connector nut of the 3.5-mm connector. Using another wrench could result in damage to the connector, which would cause incorrect measurements in the future.

Figure 2-14 Connecting test head cable to 4287A

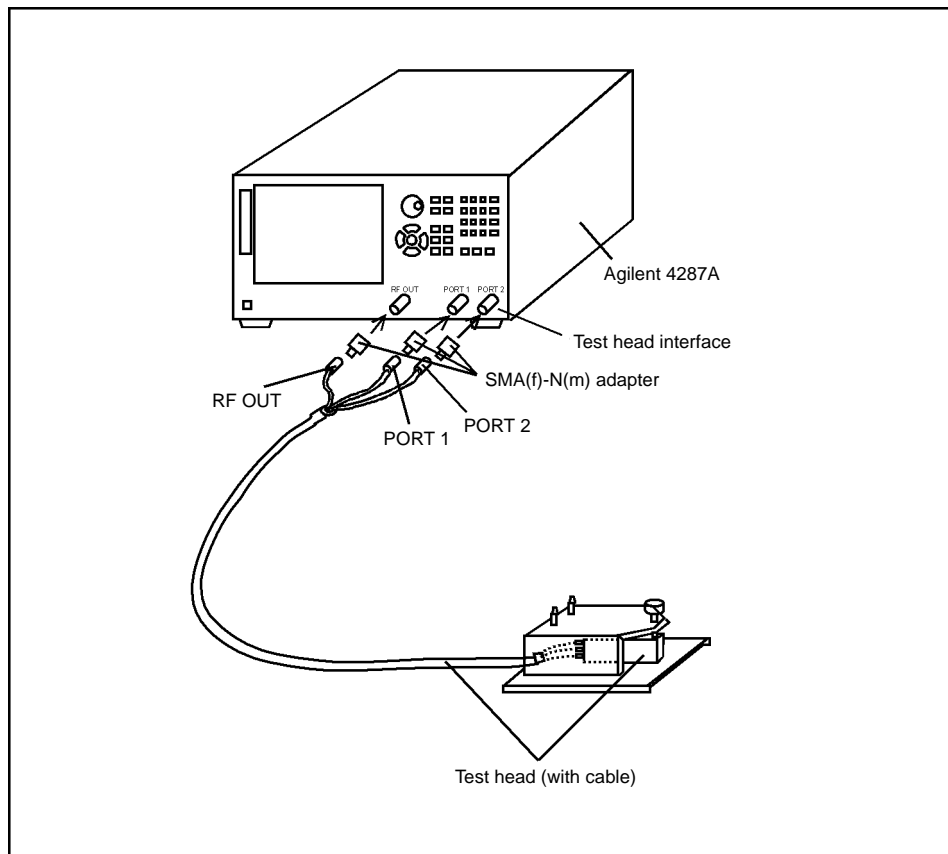

4287aoj051

When using with the test head fixed on a handler, etc.

The test head can be attached to a handler or other automatic equipment instead of using a special test fixture. In this case, secure the test head to the device using the four screw holes provided in the test head as appropriate. Connect the suitable cable, connectors, test fixture, etc. for connection of the DUT to the 3.5-mm terminal of the test head.

NOTE To minimize additional error in measurement, the distance from the test head's 3.5-mm terminal to the DUT connection side should be kept as short as possible.

Figure 2-15 Attaching test head to a handle, etc.

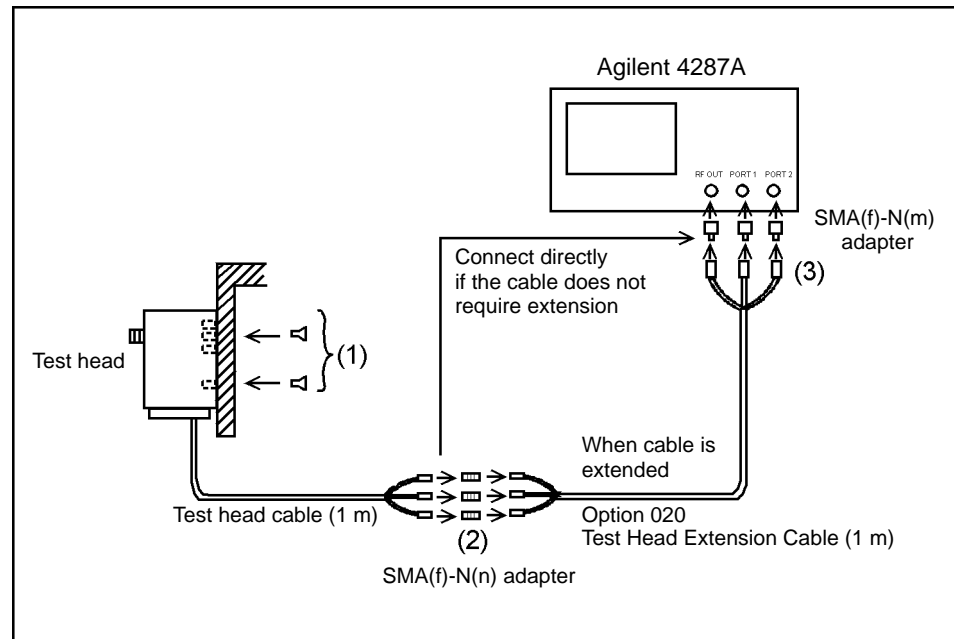

Step 1. Use one or more of the four screw holes in the test head to secure the test head to a handle or other appropriate location (Figure 2-15 (1)).

For the external dimensions of the test head and the dimensions of the screw holes, see Figure 12-12, “Test Head Dimensions (in millimeters, typical),” on page 279.

Step 2. Connect the 1-m cable already connected to the test head to the optional 020 Test Head Extension Cable (1 m) if the original length is insufficient (Figure 2-15 (2)).

Step 3. Connect the three N-type connectors (RF OUT, PORT 1, PORT 2) at the end of the cable to the respective test head interfaces (RF OUT, PORT 1, PORT 2) on the front panel of the 4287A (Figure 2-15 (3)).

Caution for connecting the SMA connector to the test head connector

Do not rotate the cable to connect the SMA(male) connector to the test head. Rotating the cable may cause damage to the cable's center conductor. Be sure to rotate the connector nut to connect the SMA cable.

Figure 2-16 Caution for connecting the SMA(male) connector

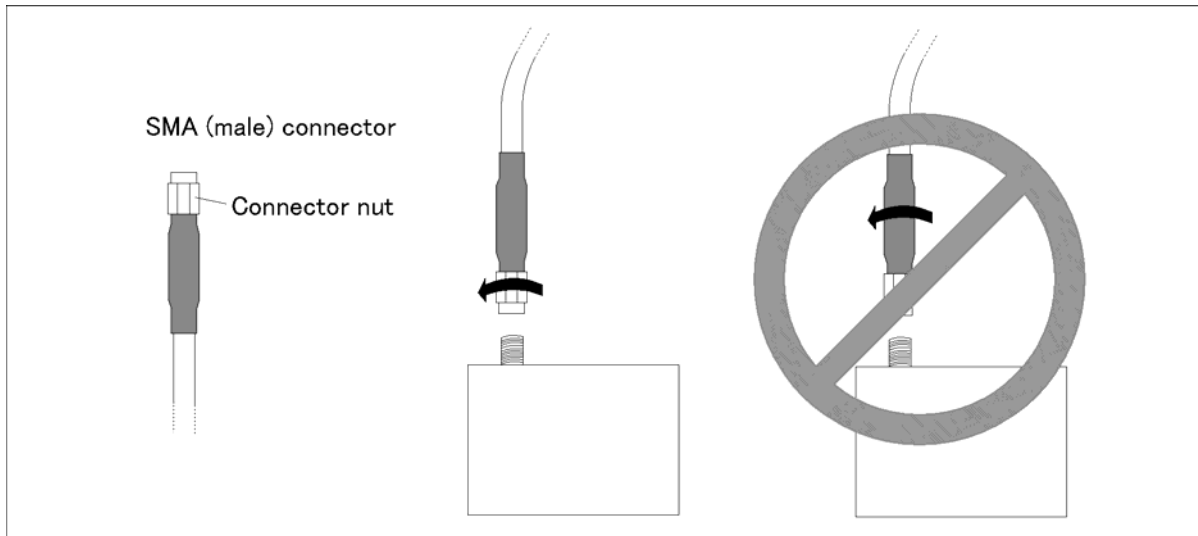

Preparation for Power Supply

Before turning on power to the equipment, be sure to verify the following:

Check the power supply

Check that the power supplied to the Agilent 4287A meets the following requirements:

	Requirements
Voltage	90 to 132 VAC or 198 to 264 VAC *1
Frequency	47 to 63 Hz
Maximum power consumption	350 VA

*1. Switched automatically by the Agilent 4287A in conformity to the voltage.

Verification and connection of power cable

The three-wire power cable attached to the Agilent 4287A has one wire serving as a ground. Use of this power cable allows the Agilent 4287A to be connected to ground, thereby protecting you against electric shock via the power outlet.

Step 1. Check whether the power cable is damaged or not.

WARNING NEVER use a power cable showing any sign of damage. Faulty cables can cause electric shock.



Step 2. Use the supplied cable to connect between the power terminal on the rear panel of the Agilent 4287A and a three-wire power outlet with the grounding prong firmly connected in the ground slot.

WARNING Use the attached three-wire power cable with grounding wire to securely ground the Agilent 4287A.

Figure 2-17 shows the power cable options.

Installation Guide
Preparation for Power Supply

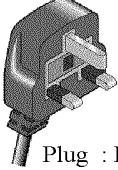
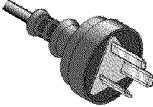
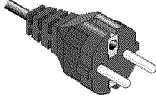
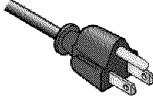
Figure 2-17 Power cable options

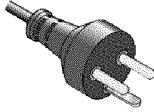
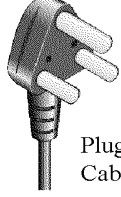
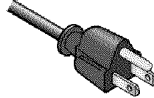
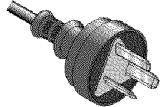
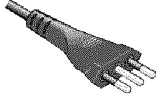
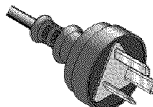
<p>OPTION 900</p>  <p>United Kingdom</p> <p>Plug : BS 1363/A, 250V, 10A Cable: 8120-1351</p>	<p>OPTION 901</p>  <p>Australia/ New Zealand</p> <p>Plug : AS 3112, 250V, 10A Cable: 8120-1369</p>
<p>OPTION 902</p>  <p>Continental Europe</p> <p>Plug : CEE 7 Standard Sheet VII, 250V, 10A Cable: 8120-1689</p>	<p>OPTION 903</p>  <p>U.S./ Canada</p> <p>Plug : NEMA 5-15P, 125V, 10A Cable: 8120-1378</p>
<p>OPTION 904</p>  <p>U.S./ Canada</p> <p>Plug : NEMA 6-15P, 250V, 6A Cable: 8120-0698</p>	<p>OPTION 906</p>  <p>Switzerland</p> <p>Plug : SEV Type 12, 250V, 10A Cable: 8120-2104</p>
<p>OPTION 912</p>  <p>Denmark</p> <p>Plug : SR 107-2-D, 250V, 10A Cable: 8120-2956</p>	<p>OPTION 917</p>  <p>India/ Republic of S.Africa</p> <p>Plug : IEC 83-B1, 250V, 10A Cable: 8120-4211</p>
<p>OPTION 918</p>  <p>Japan</p> <p>Plug : JIS C 8303, 125V, 12A Cable: 8120-4753</p>	<p>OPTION 920</p>  <p>Argentina</p> <p>Plug : Argentine Resolution 63, Annex IV, 250V, 10A Cable: 8120-6870</p>
<p>OPTION 921</p>  <p>Chile</p> <p>Plug : CEI 23-16, 250V, 10A Cable: 8120-6978</p>	<p>OPTION 922</p>  <p>China</p> <p>Plug : GB 1002, 250V, 10A Cable: 8120-8376</p>
<p>If you want to use a power cable other than the supplied one, contact your nearest Agilent sales office for information.</p>	

4287aoj005

Blown fuse

If the fuse appears to have blown during operation, this equipment may be subject to failure and must be repaired. Contact the Agilent Technologies sales office or the company from which you purchased the equipment.

spec :UL/CSA Type, Slo-Blo, 8 A 250 V

WARNING

Do NOT replace the fuse yourself: this may be dangerous.

Turning the Power ON and OFF

Perform the following steps to turn the power ON or OFF.

Turning the power ON

Step 1. If the standby switch (⏻) in the lower-left part of the front panel is in the pressed down (⏻) position, press the switch to the popped up position (⏻).

Step 2. Press the standby switch to the pressed down position (⏻).

This operation turns ON the power, and the 4287A starts the self-test.

Step 3. Confirm that the self-test indicates normal operation.

Normal operation is confirmed by the self-test if no error message appears.

Turning the power OFF

Step 1. Use either of the following methods to turn OFF the 4287A.

- Press the standby switch (⏻) in the lower-left part of the front panel (now in the pressed down (⏻) position) to the popped up (⏻) position.
- Send the shutdown command from an external controller.

These operations will start the 4287A shutdown process (required software and hardware processes for turning the power off), and the power will turn OFF after a few seconds.

NOTE

Under normal circumstances, always press the standby switch (⏻), or send the shutdown command from the external controller, to actuate the 4287A shutdown process. **Never cut off the power supply directly by disconnecting the power cable plug from the rear panel of the unit.**

If the power supply is cut off directly by disconnecting the power cable plug or by disconnecting the power supply to the AC outlet, the shutdown process will not be carried out, and there is a risk of damage to the software or hardware of the 4287A.

Disconnection from Supply Source

The disconnecting device (device cutting off the power supply) of the 4287A is the plug of the power cable (on AC outlet side or 4287A side). When it is necessary to disconnect the power supply in order to avoid shock hazards, etc., pull out the power cable plug from either the AC outlet side or the 4287A side.

NOTE

To allow this operation to be performed smoothly, be sure to follow the guidelines in “Ensure free space is available around unit to allow speedy disconnection of power cable in case of emergency” on page 21.

When turning the power OFF under normal circumstances, always follow the methods described in “Turning the power OFF” on page 38.

Initial Registration of 4287A

When you start up the 4287A for the first time or after executing system recovery, you need to perform the initial registration of the Windows 2000 operating system of the 4287A.

NOTE You cannot use the front panel keys during the initial registration of the 4287A therefore connect the mouse and the keyboard before turning on the power. An USB mouse is not supported.

NOTE If you perform the following procedure incorrectly, a message asking you whether to return to the previous registration screen and perform the registration appears. In this case, follow the instruction to return to the previous registration screen.

Step 1. Turns on the 4287A.

Step 2. The Windows 2000 Professional Setup wizard appears. Click the **Next >** button (Figure 2-18).

Figure 2-18 Windows 2000 Professional Setup wizard

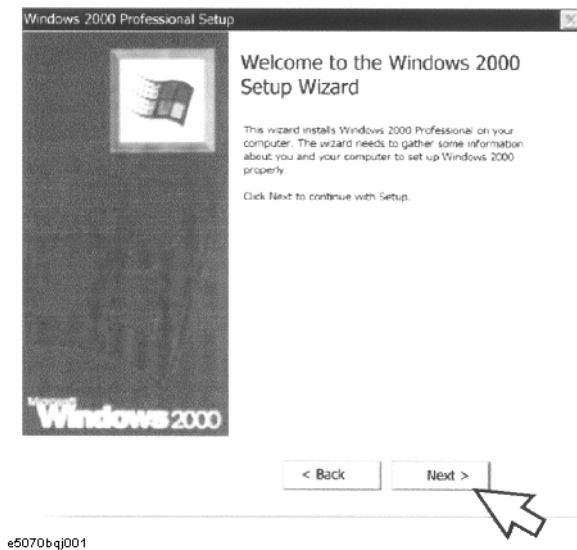

Step 3. In the Windows 2000 Professional Setup dialog box, select the **I accept this agreement** box and click the **Next >** button (Figure 2-19). Then, the Windows 2000 operating system is restarted automatically.

Figure 2-19 Windows 2000 Professional Setup dialog box

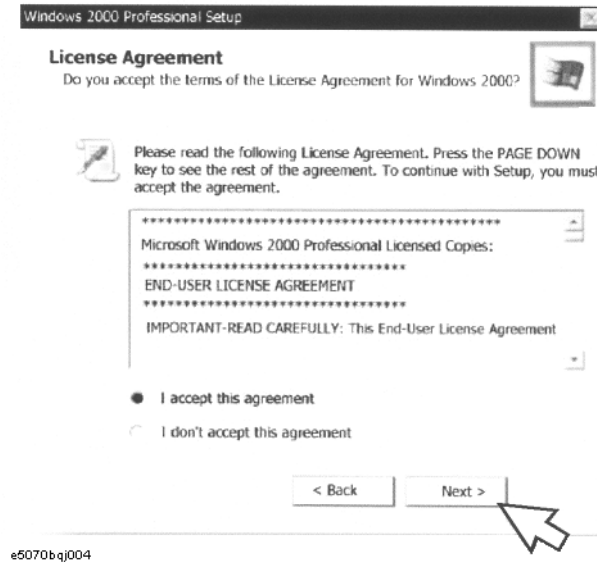

Step 4. The Network Identification wizard appears. Click the **Next >** button (Figure 2-20).

Figure 2-20 Network Identification wizard

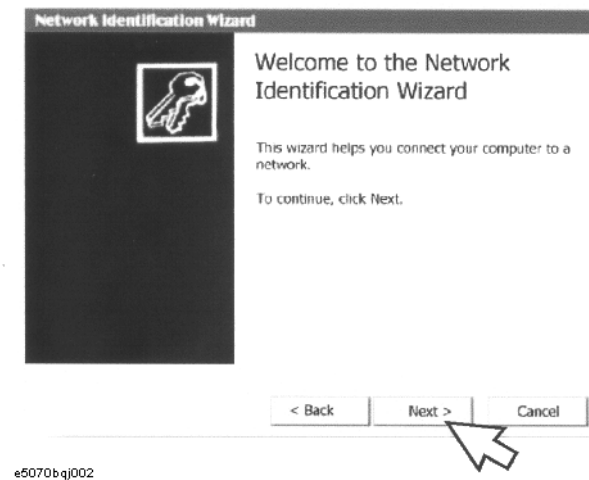

Step 5. In the Network Identification Wizard dialog box (1/2), select the **Windows always assumes the following user has logged on to this computer** box and check that **agt_instr** is in the **User Name** box. If not, type in **agt_instr**. Finally, click the **Next>** button (Figure 2-21).

Figure 2-21 Network Identification Wizard dialog box (1/2)

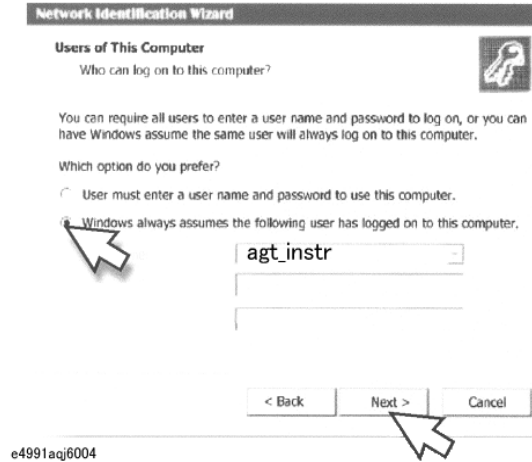

Step 6. In the Network Identification Wizard dialog box (2/2), click the **Finish** button to finish the initial registration of the 4287A (Figure 2-22). Then, the measurement display of the 4287A appears.

Figure 2-22 Network Identification Wizard dialog box (2/2)

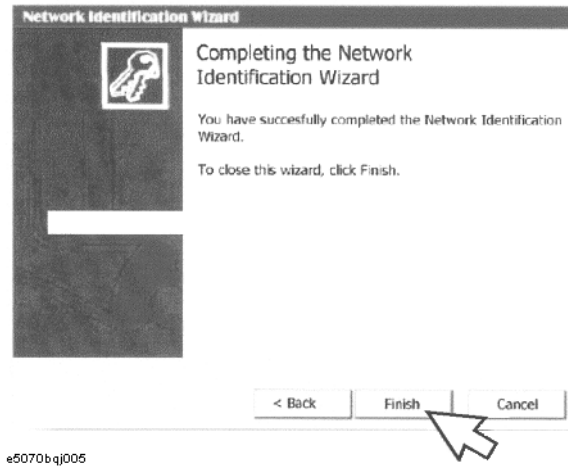

Setting the Internal Clock

You can set the date/time displayed at the lower right of the screen. When you save data in the storage unit, for example, the internal clock data will be used. The following describes the setting procedure that uses keys on the front panel.

NOTE

When turning on the instrument power for the first time after delivery, always be sure to set the internal clock.

Setting the Date/Time

- Step 1.** Press the **[System]** key and press **Set Date and Time** button the Date/Time Properties dialog box will appear (Figure 2-23).

Figure 2-23

Date/Time Properties Dialog Box (“Date & Time” Tab)

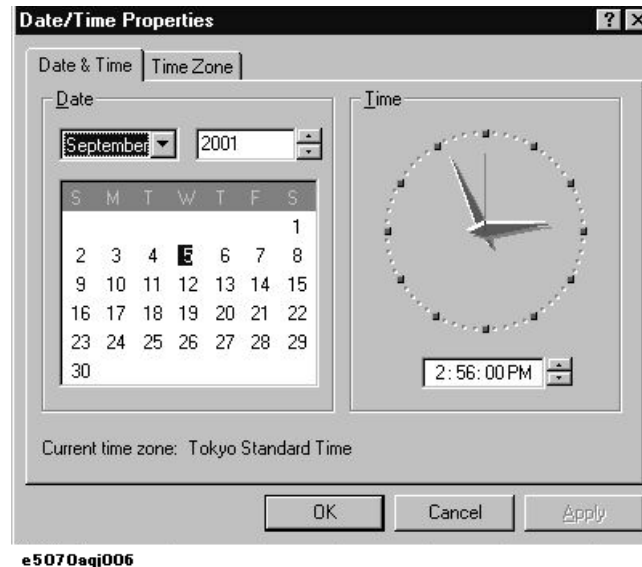

- Step 2.** Turn the rotary knob (⊙) on the front panel to point the focus to the **Date & Time** tab and press the **[→]** key to move the focus to the **Time Zone** tab (Figure 2-24).

Figure 2-24

Date/Time Properties Dialog Box (“Time Zone” Tab)



e5070aqj005

- Step 3.** Turn the rotary knob (⊙) on the front panel to point the focus to the **Time Zone** box and press the [←]/[→] or [↓]/[↑] key to select the time zone.

NOTE

When you select the time zone for summer time, the **Automatically adjust clock for daylight saving changes** box becomes selectable. To set the function of automatically making summertime adjustment to ON, turn the rotary knob (⊙) to point the focus to the **Automatically adjust clock for daylight saving changes** box and press the rotary knob (⊙) to display the ✓ mark (Figure 2-24).

- Step 4.** Turn the rotary knob (⊙) on the front panel to point the focus to the **Time Zone** tab and press the [←] key to move the focus to the **Date & Time** tab.
- Step 5.** By referring to Figure 2-23, turn the rotary knob (⊙) on the front panel to point the focus to the desired item. Press the [←]/[→] or [↓]/[↑] key to set each item.
- Step 6.** Turn the rotary knob (⊙) on the front panel to point the focus to the **OK** button and then press [Enter] key.

Turning the Date/Time Display ON and OFF



The Date/time is displayed within the instrument status bar at the lower right of the display screen.

- Step 1.** Press the [System] key in the INSTR STATE block. Press the [↓] or [↑] key to move the focus to the **Misc Setup** button and then press the [Enter] or [→] key. Press the [↓] or [↑] key, move the focus to the **Clock Setup** button, and press the [Enter] or [→] key. Point the focus to the **Show Clock** button and press the [Enter] key to set the date/time display on/off.

Selection of Test Fixture

When the DUT is attached and detached by manual operation, it is possible to use special test fixtures. Select the appropriate test fixture by referring to Table 2-6. The options listed in the table may not cover all conditions and characteristics, so please confirm detailed specifications by referring to the appropriate accessory catalogs and operation manuals.

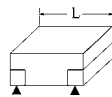
Table 2-6 Usable test fixtures

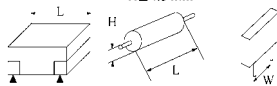
Test Fixture	Frequency Range	Components Size (SMD)
16196A	DC to 3 GHz	1608 mm/0603 inch
16196B	DC to 3 GHz	1005 mm/0402 inch
16196C	DC to 3 GHz	0603 mm/0201 inch
16197A	DC to 3 GHz	*1 L=0.6 - 3.2 mm 
16191A	DC to 2 GHz	*1 L=2.0 - 12.0 mm 
16192A	DC to 2 GHz	*1 L=1.0 - 20.0 mm 
16194A	DC to 2 GHz	*1 L=2.0 - 15.0 mm L ≤ 15 mm H ≤ 4.5 mm W=8.0 - 21.0 mm 

*1. ▲ indicates the direction of contact of the test fixture's electrode.

NOTE

When a special test fixture is used, it is necessary to first attach the test head to the test fixture stand (at this point, the test head's 3.5-mm terminal is converted to a 7-mm terminal by using the 3.5-mm-to-7-mm adapter). For details on how to attach the test head to the test fixture stand, see "Connecting the DUT when using a special test fixture" on page 31.

About connection of test fixture and DUT

Before actually connecting a DUT and performing measurement, it is necessary to set the measurement conditions and perform calibration and compensation. Some calibration and compensation operations have to be performed before the test fixture is connected to the test head. Accordingly, before connecting the test fixture and the DUT, be sure to set the measurement conditions and perform calibration and compensation as outlined in Chapter 5, “Setting Measurement Conditions,” on page 101 and Chapter 6, “Calibration and Compensation,” on page 115.

Instructions for Cleaning

To prevent electrical shock, disconnect the 4287A's power cable from the power outlet before cleaning.

To clean the exterior of the 4287A, gently wipe the surfaces with a clean dry cloth or a clean cloth that has been soaked with water and wrung tightly. Do not attempt to clean the 4287A internally.

Precautions Required When Connecting the 4287A to Automatic Equipment (Handler), etc.

When using the 4287A along with a handler or other automatic equipment in a system, pay particular attention to the following points.

- ❑ When turning OFF the 4287A, be sure use the standby switch on the front panel or the shutdown command from an external controller. For details, see “Turning the power OFF” on page 38.
- ❑ To confirm the timing of all of the 4287A’s operations and the automatic equipment (or controller), use the 4287A’s handler interface synchronizing signals (/INDEX, /EOM, /READY_FOR_TRIG) and the status report mechanism to detect the condition of each process and to control the automatic equipment synchronized with these signals. By performing synchronization, trigger errors can be prevented and the measurement throughput can be maximized. For details on how to make the timing with the automatic equipment, see the *Programming Manual*.
- ❑ If you obtain DC resistance measurement with variance due to noise, it may be caused by common mode noise which enters the 4287A via the test head cable and the GPIB cable. To decrease this noise, insert the part where the cables of the test head are tied into ferrite cores as many as possible (see Figure 2-25). If you connect a GPIB cable, wind it around a core as many turns as possible (see Figure 2-26).

Use cores having large impedance at low frequency. The following table shows some example of the cores which you can get as of December 2001.

For the test head cable	Toshiba FS26x16x10W μ : 100000 @ 10 kHz AL-value: 67.8 $\mu\text{H}/\text{N}^2$ @ 10 kHz
For the GPIB cable	Hitachi Metals F10080G μ : 70000 @ 10 kHz AL-value: 30.0 - 65 $\mu\text{H}/\text{N}^2$ @ 10 kHz

- ❑ When performing calibration and compensation, it is recommended that you use the internal raw data for calibration and compensation to determine the success or failure of the calibration and compensation. For details, see the chapter “Preparations for Accurate Measurement” in the *Programming Manual*.
- ❑ Do not rotate the cable to connect the SMA(male) connector to the test head. Rotating the cable may cause damage to the cable’s center conductor. Be sure to rotate the connector nut to connect the SMA cable. For more details, refer to the “Caution for connecting the SMA connector to the test head connector” on page 34.

Figure 2-25 Using cores (test head cable)

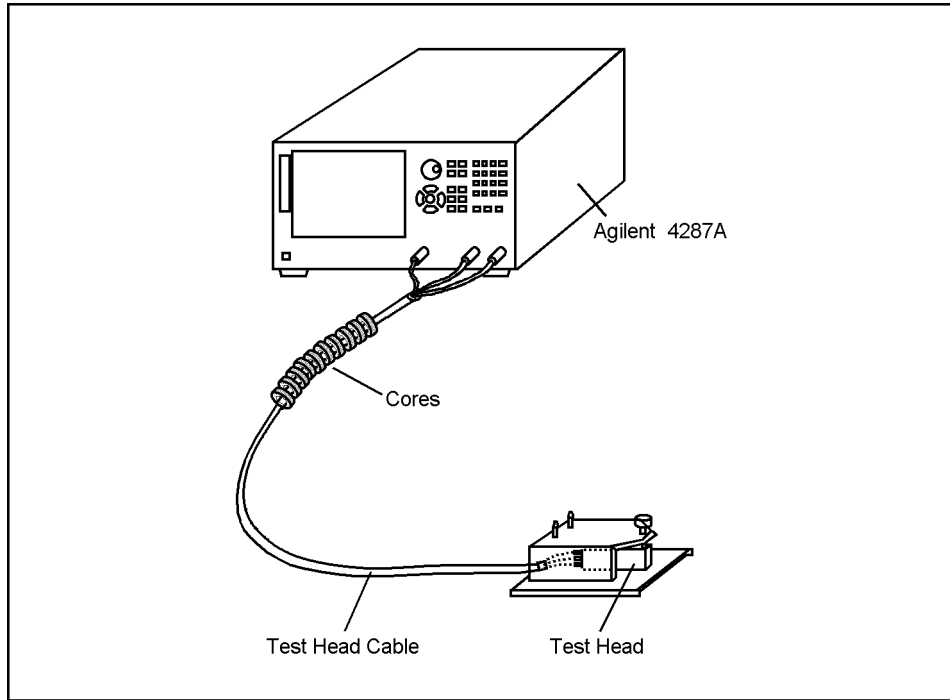

4287a0e167

Figure 2-26 Using a core (GPIB cable)

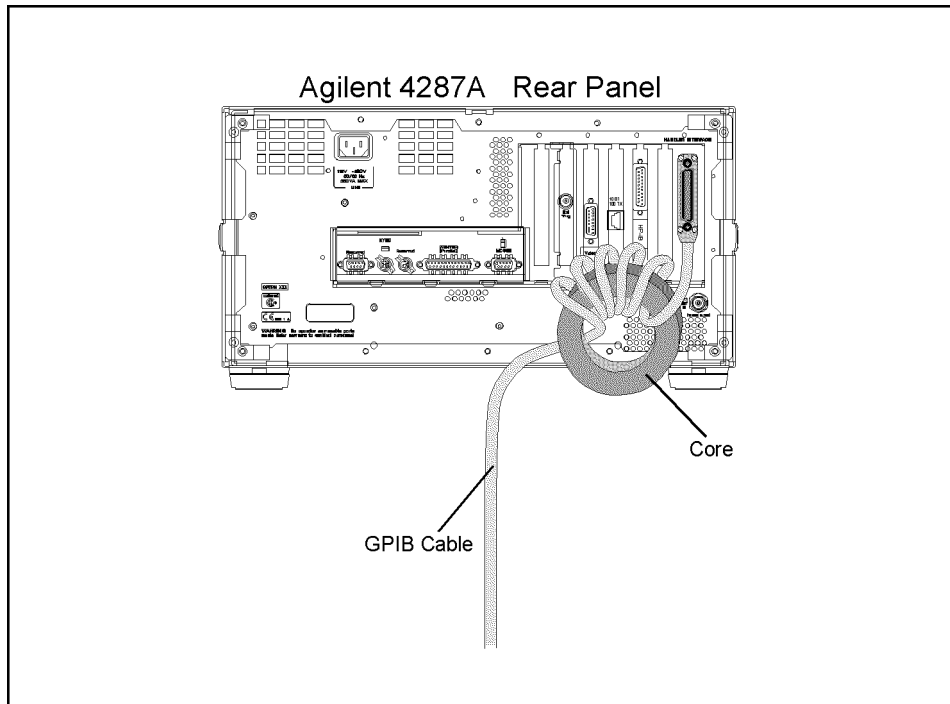

4287a0e166

3 Learning Basic Operations

This chapter explains the basic operation procedures of the Agilent Technologies 4287A RF LCR Meter by using measurement examples. This is intended to familiarize you with the 4287A if you are using this instrument for the first time.

What You Must Keep on Hand

To use the examples of measurement shown in this chapter, prepare the following items:

Table 3-1

What you must keep on hand

Name	Quantity
Agilent 4287A RF LCR meter (with mouse)	1
Test head (with 1-meter cable) ^{*1}	1
N(m)-SMA(f) adapter ^{*2}	3
Wrench (for 3.5-mm/SMA connector) ^{*2}	1
Agilent 16195B 7-mm calibration kit ^{*3}	1
Test fixture stand ^{*4}	1
3.5-mm-to-7-mm adapter ^{*5}	1
Agilent 16196A SMD Test Fixture ^{*6}	1
DUT: Chip inductor (connectable to test fixture to be used)	1

*1. Included with the 4287A

*2. Included with the standard 4287A

*3. Included with the Option 700

*4. Included with the Option 710

*5. Included with the Option 720

*6. Other test fixtures can be used if compatible with the 7-mm connector of the same type.

Figure 3-1 What you must keep on hand

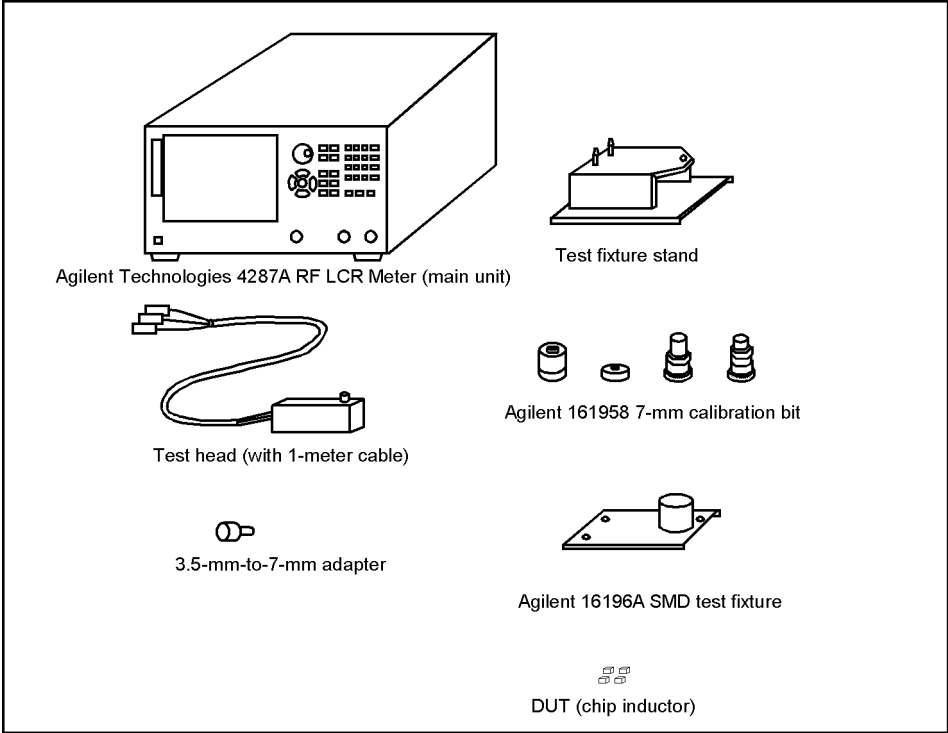

4287aoj015

Preparation for Measurement

Connection between test head and fixture stand

Connect the test head (with 1-meter cable) and test fixture stand to the 4287A as shown in Figure 3-2. For details, see "Connecting the DUT When Using Special Test Fixture" on page 29.

Figure 3-2 Connection between test head and fixture stand

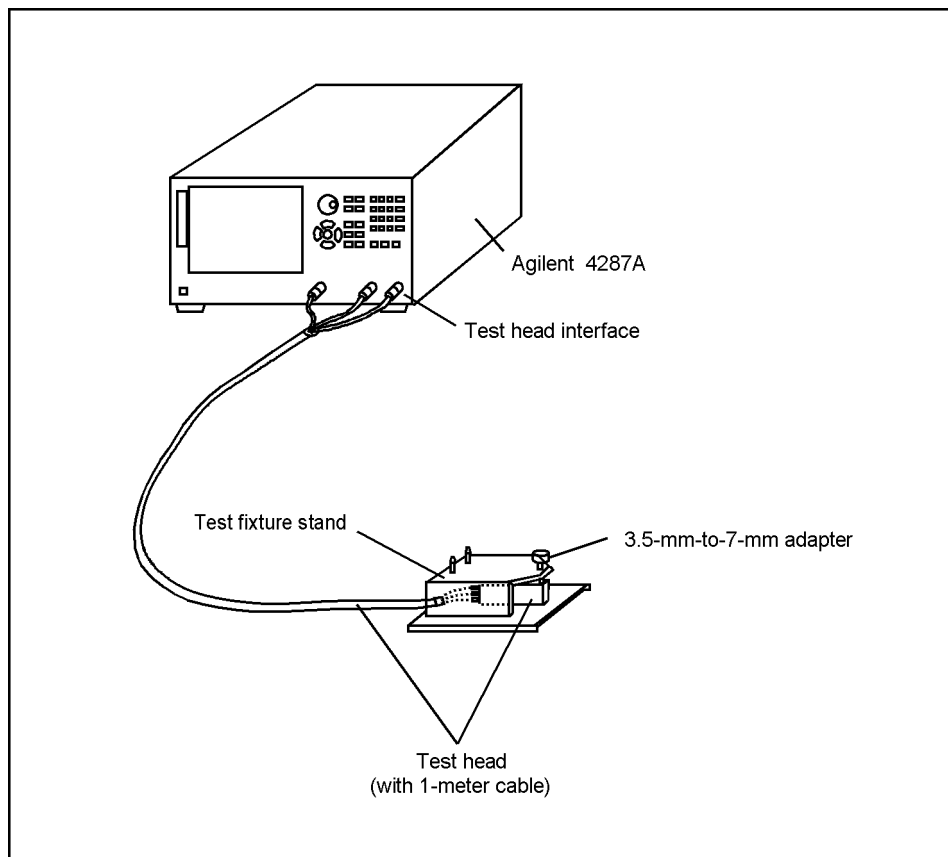

4287aoe022

NOTE

Open/short/load calibration at the 7-mm-terminal on the tip of the test head is described later in this chapter. Here the test fixtures (Agilent Technologies 16196A, etc.) for connection of the DUT are not installed on the test head.

Turning ON the power

Press the power switch in the lower-left area of the 4287A front panel to turn on the power.

NOTE

Extra caution is required when turning the 4287A power ON or OFF. See “Turning the Power ON and OFF” on page 35.

When the power switch is pressed, the 4287A starts the self-test. After confirmation of normal operation, the measurement display (Figure 3-3) will appear based on the power-on default settings.

Figure 3-3

Screen when power is turned ON (single point measurement display)

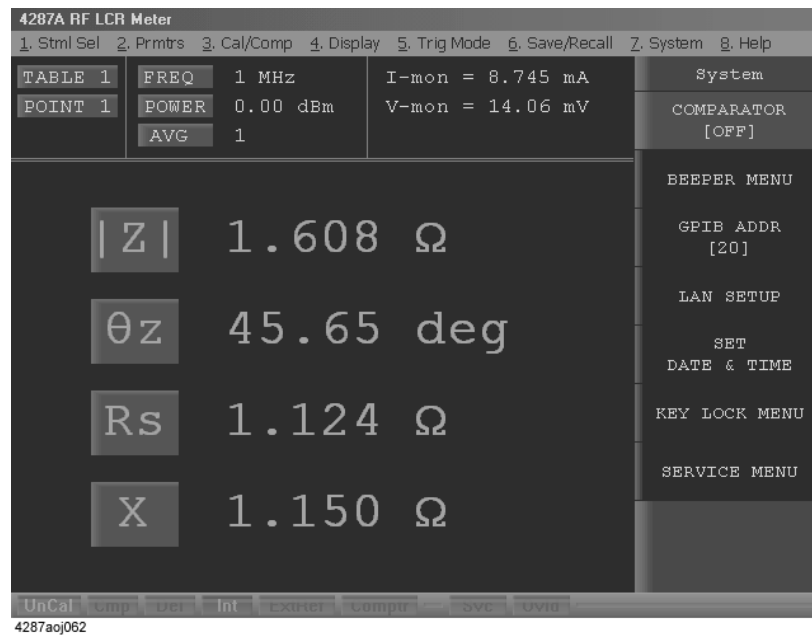

How to Set Measuring Conditions

This sections explains how to set the measuring conditions.

NOTE

The following explanation of how to set measuring conditions assumes that you are using the keys on the front panel of the 4287A. If you want to know the setting procedure when using a keyboard or mouse, see “4287A Key Operation Overview” on page 99.

Presetting the 4287A

Press the [Preset] key on the right corner of the front panel to preset the 4287A to its initially set state called “Preset state.”

How to set the measurement point (frequency/averaging factor/oscillator level)

With the 4287A, you must enter the desired measurement point along with its conditions in the measurement point setup display before starting measurement. The following procedure shows a case when four measurement points with different frequencies (i.e., 1 MHz, 10 MHz, 100 MHz, and 1 GHz) are set up.

For all four points, the averaging factor is assumed as 1 and the oscillator level as 0 dBm.

- Step 1.** Press the [Setup View] key on the measurement block (MEASUREMENT) of the front panel once, and the measurement point setup display will appear (Figure 3-4).

Figure 3-4

Measurement point setup display

No.	Frequency	Average	Power	dBm
1	1.0000 MHz	1	-13.0	dBm
2				
3				
4				
5				
6				
7				
8				
9				
10				
11				
12				
13				
14				
15				
16				
17				
18				
19				

Step 2. Press the  key in the navigation block (NAVIGATION) on the front panel twice to move the cursor to the Frequency cell of measurement point 2 (Figure 3-5).

Figure 3-5

Cursor moved to frequency cell of measurement point number 2

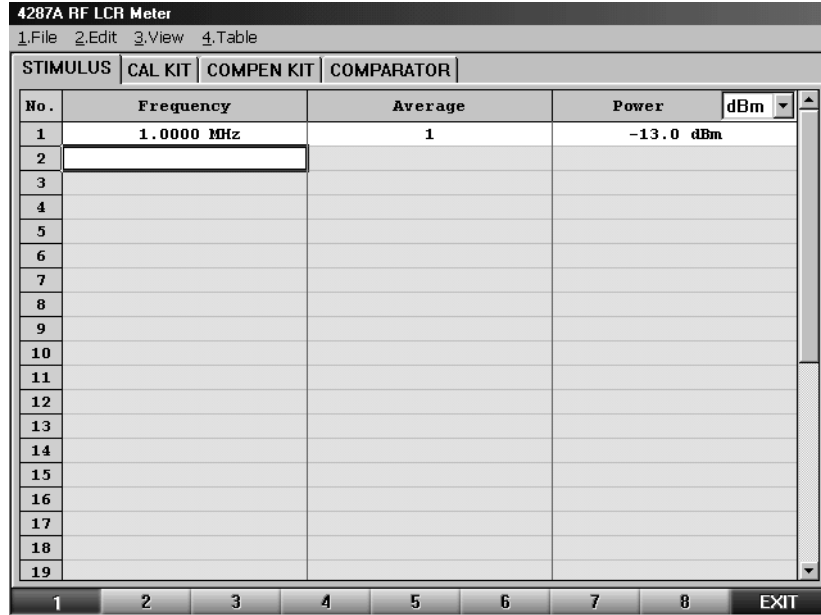

No.	Frequency	Average	Power	dBm
1	1.0000 MHz	1	-13.0	dBm
2				
3				
4				
5				
6				
7				
8				
9				
10				
11				
12				
13				
14				
15				
16				
17				
18				
19				

Step 3. Press the [1], [0], and [M/μ] keys on the entry block of the front panel consecutively and set the frequency of measurement point number 2 to 10 MHz (Figure 3-6).

Figure 3-6

Frequency of measurement point number 2 set to 10 MHz

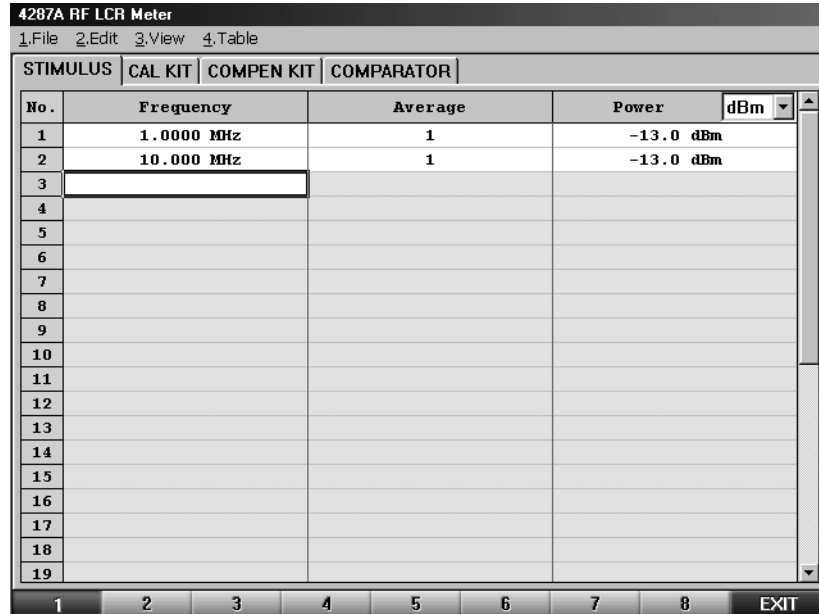

No.	Frequency	Average	Power	dBm
1	1.0000 MHz	1	-13.0	dBm
2	10.000 MHz	1	-13.0	dBm
3				
4				
5				
6				
7				
8				
9				
10				
11				
12				
13				
14				
15				
16				
17				
18				
19				

Step 4. Press the [1], [0], [0], and [M/μ] keys on the entry block of the front panel consecutively and set the frequency of measurement point number 3 to 100 MHz (Figure 3-7).

Figure 3-7

Frequency of measurement point number 3 set to 100 MHz

The screenshot shows the '4287A RF LCR Meter' interface with a menu bar (1.File, 2.Edit, 3.View, 4.Table) and tabs for STIMULUS, CAL KIT, COMPEN KIT, and COMPARATOR. A table displays measurement data for points 1 through 19. Point 3 is highlighted with a black border, showing a frequency of 100.00 MHz, an average of 1, and a power of -13.0 dBm. The 'dBm' unit is selected in a dropdown menu.

No.	Frequency	Average	Power	dBm
1	1.0000 MHz	1	-13.0	dBm
2	10.000 MHz	1	-13.0	dBm
3	100.00 MHz	1	-13.0	dBm
4				
5				
6				
7				
8				
9				
10				
11				
12				
13				
14				
15				
16				
17				
18				
19				

Step 5. Press the [1] and [G/n] keys on the entry block of the front panel consecutively and set the frequency of measurement point number 4 to 1 GHz (Figure 3-8).

Figure 3-8

Frequency of measurement point number 4 set to 1 GHz

The screenshot shows the '4287A RF LCR Meter' interface with a menu bar (1.File, 2.Edit, 3.View, 4.Table) and tabs for STIMULUS, CAL KIT, COMPEN KIT, and COMPARATOR. A table displays measurement data for points 1 through 19. Point 4 is highlighted with a black border, showing a frequency of 1.0000 GHz, an average of 1, and a power of -13.0 dBm. The 'dBm' unit is selected in a dropdown menu.

No.	Frequency	Average	Power	dBm
1	1.0000 MHz	1	-13.0	dBm
2	10.000 MHz	1	-13.0	dBm
3	100.00 MHz	1	-13.0	dBm
4	1.0000 GHz	1	-13.0	dBm
5				
6				
7				
8				
9				
10				
11				
12				
13				
14				
15				
16				
17				
18				
19				

Step 6. Press the [Meas View] key on the measurement block of the front panel to go back to the first single point measurement display (Figure 3-3 on page 53).

Calibration and Compensation

After completing measurement point setting, perform calibration and compensation

NOTE

Calibration and compensation are carried out at the same point as the normally set measurement point; therefore, the measurement point setting should have been completed before calibration and compensation.

The following description uses the “wizard” function, which ensures easy execution of calibration and compensation by displaying clear and simple guidance.

Low-loss capacitor calibration, port extension compensation, open compensation, and short compensation in addition to open/short/load calibration are explained in the measurement examples below.

The definition of the calibration kit and compensation kit remains the same as that in the presetting phase.

Setting with the calibration and compensation wizard

Perform the following steps before using the calibration and compensation wizard to make settings.

NOTE

When using test fixtures other than 16191A, 16192A, 16193A, 16194A, 16196A, 16196B, or 16196C, register the electrical length as described in “Registering the Electrical Length of Unregistered Test Fixtures” on page 149 before making settings using the calibration and compensation wizard.

- Step 1.** Press the **[Cal/Compen]** key in the instrument state block (INSTR STATE) on the front panel to display the Cal/Compen softkey menu in the right side of the screen.
- Step 2.** Turn the rotary knob (⊙) in the navigation block (NAVIGATION) on the front panel to move the cursor in the softkey menu to the **SETUP CAL WIZARD** key.
- Step 3.** Press the rotary knob (⊙) to display the Calibration Wizard Setting dialog box (Figure 3-9).



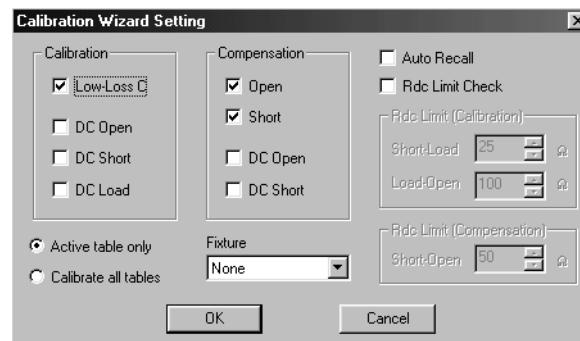

Figure 3-9

Calibration Wizard Setting dialog box





NOTE

When using the 4287A for measurement, open compensation, short compensation and load compensation must be performed under any circumstance. The calibration and compensation wizard setting feature has been designed so that, in addition to these three essential settings, your desired calibration and compensation settings may be selected.



- Step 4.** Confirm that a check mark \surd appears in the **Low-Loss C** check box in the Calibration area.
- Step 5.** Confirm that a check mark (\surd) only appears in the **Open** and **Short** check boxes in the Compensation area.
- Step 6.** Confirm that **Active table only** is selected (●) so that calibration and compensation is only performed for the measurement point in the selected measurement point table.
- Step 7.** Press the  key or  key on the front panel the required number of times to move the cursor to the Fixture box.
- Step 8.** Press the  key or  key on the front panel the required number of times to select the model number of the test fixture to be used.

NOTE

When using test fixtures other than 16191A, 16192A, 16193A, 16194A, 16196A, 16196B, or 16196C, the electrical length must be registered as described in “Registering the Electrical Length of Unregistered Test Fixtures” on page 149 before making settings with the calibration and compensation wizard. When the name of the test fixture and its electrical length are registered, the test fixture becomes selectable in Step 8 of this procedure.

- Step 9.** Press the  key or  key on the front panel the required number of times to move the cursor to the **OK** button.
- Step 10.** Press the  key on the front panel the required number of times to complete the setting of the calibration and compensation wizard and close the dialog box.

NOTE

To cancel the setting of the calibration and compensation wizard, press the  key or the  key on the front panel to move the cursor in the dialog box to the **Cancel** button and then press the  key. If the setting is cancelled, the settings shown when the dialog box was first opened will remain unchanged and be used as they are.

Executing short calibration

Use the following procedure to perform short calibration of the 7-mm terminal on the tip of the test head.

- Step 1.** Turn the rotary knob () to move the cursor in the softkey menu to the **CAL WIZARD** key.

- Step 2.** Press the rotary knob (⊙) to display the calibration and compensation wizard welcome window (Figure 3-10).

Figure 3-10 Calibration and compensation wizard welcome window

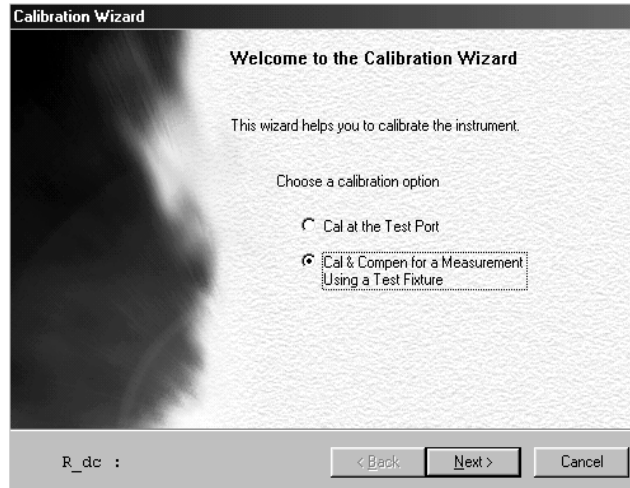

- Step 3.** Press the key or key on the front panel to select the **Cal/Compen for a Fixture Measurement** option (●) (filled circle should appear inside the radio button).
- Step 4.** Press the key or key on the front panel the required number of times to move the cursor to the **Next>** button.
- Step 5.** Press the key on the front panel. The window for setting up the test head and test fixture stand (Figure 3-11) appears.

Figure 3-11 Display for setting up test head and test fixture stand

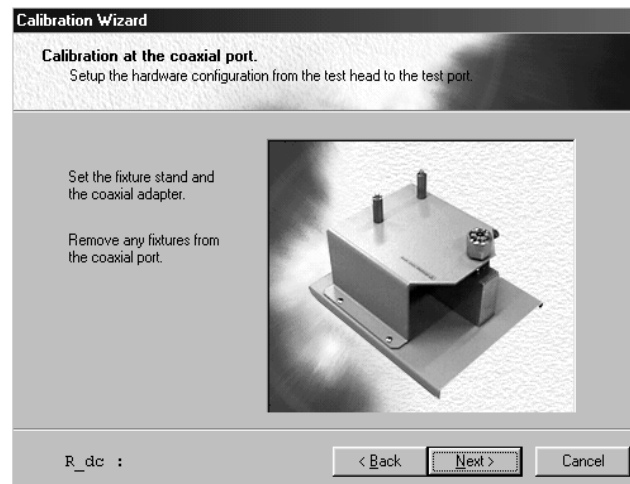

- Step 6.** Confirm that the setup has been performed as shown in Figure 3-2, “Connection between test head and fixture stand,” on page 52 (in this condition nothing should be connected to the 7-mm terminal).



- Step 7.** Press the  key or  key on the front panel the required number of times to move the cursor to the **Next>** button.
- Step 8.** Press the  key on the front panel. The window for short calibration (Figure 3-12) appears.

Figure 3-12

Window for short calibration



- Step 9.** The outside of the 7-mm connector of the test head installed on the test fixture stand should be turned clockwise until the connector sleeve protrudes to its full extent at the top (Figure 3-13).

Figure 3-13

How to extend 7-mm connector sleeve

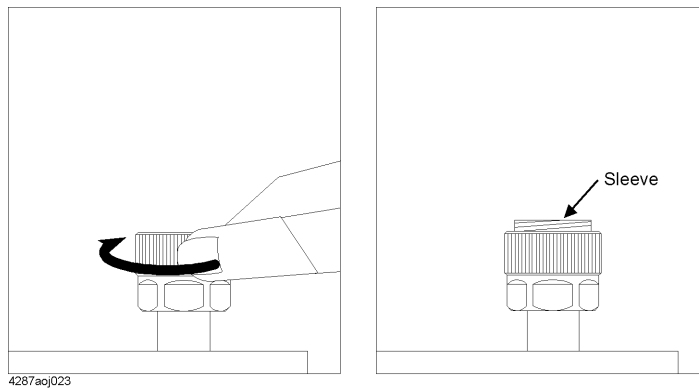

- Step 10.** While pressing on the short standard ($0\ \Omega$) from the top, turn it clockwise and securely connect it to the 7-mm terminal (Figure 3-14).

Figure 3-14 How to connect short standard

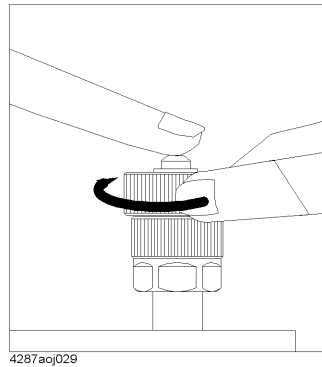

NOTE

After turning the connector nut of the short standard and attaching it to the 7-mm terminal, it is not necessary to turn the connector nut of the 7-mm terminal on the test head side to fix it in position. This also applies to the installations of the open standard, low-loss capacitor and load standard explained in this section.

- Step 11.** Press the key or key on the front panel the required number of times to move the cursor to the **Next>** button.
- Step 12.** Press the key on the front panel to start measurement of short calibration data. The bar in the Calibration progress indicator in the calibration window indicates the progress of the short calibration data measurement. Upon completion of short calibration data measurement, the screen changes to the next window (Figure 3-15).

Executing open calibration

Figure 3-15 Open calibration window







- Step 1.** Turn the outside of the short standard counterclockwise and remove it from the 7-mm terminal.

- Step 2.** While pressing the open standard (OS) from above, turn it clockwise and securely connect it to the 7-mm terminal (Figure 3-16).

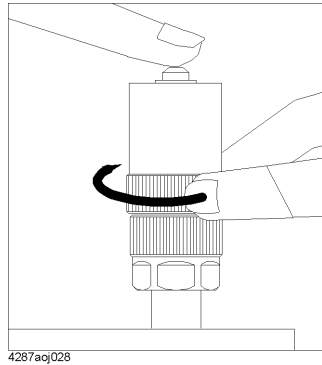
Figure 3-16

How to connect open standard



- Step 3.** Press the  key or  key on the front panel the required number of times to move the cursor to the **Next>** button.
- Step 4.** Press the  key on the front panel to start measurement of open calibration data. The bar in the Calibration progress indicator in the calibration window indicates the progress of the open calibration data measurement. Upon completion of open calibration data measurement, the screen changes to the next window (Figure 3-17).

Executing low-loss capacitor calibration

Figure 3-17

Low-loss capacitor calibration window

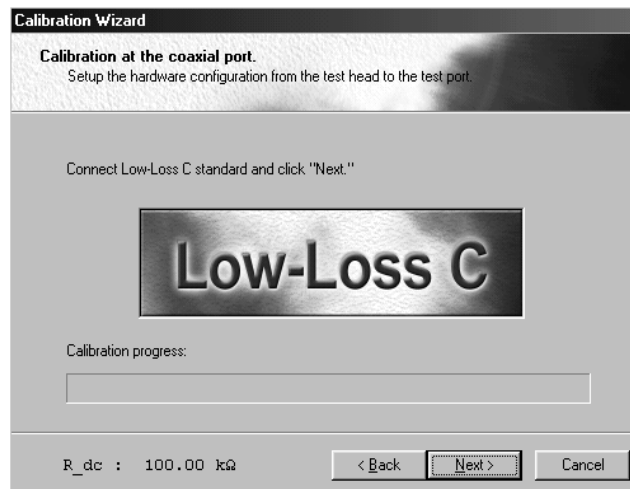

- Step 1.** Turn the outside of the open standard counterclockwise and remove it from the 7-mm terminal.
- Step 2.** While pressing the low-loss capacitor from above, turn it clockwise and securely connect it to the 7-mm terminal (Figure 3-18).

Figure 3-18

How to connect low-loss capacitor

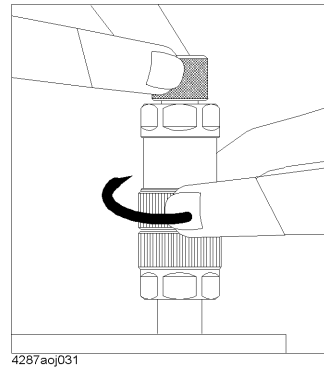

- Step 3.** Press the key or key on the front panel the required number of times to move the cursor to the **Next>** button.
- Step 4.** Press the key on the front panel to start measurement of low-loss capacitor calibration data. The bar in the Calibration progress indicator in the calibration window indicates the progress of the low-loss capacitor calibration data measurement. Upon completion of low-loss capacitor calibration data measurement, the screen changes to the next window (Figure 3-19).

Executing load calibration

Figure 3-19

Load calibration window

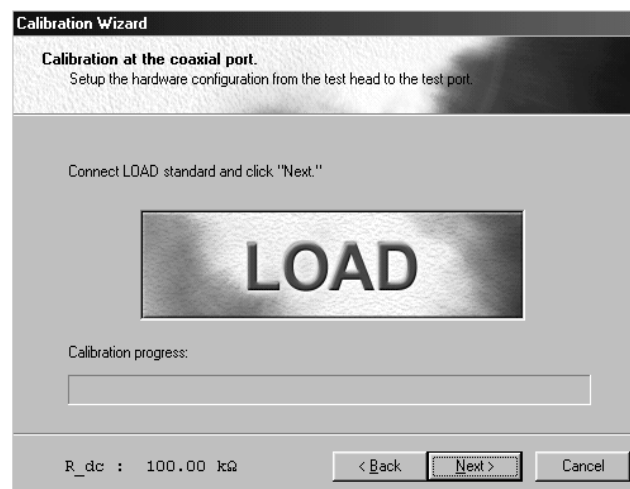

- Step 1.** Turn the connector nut of the low-loss capacitor counterclockwise to remove it from the 7-mm terminal.
- Step 2.** As shown in Figure 3-20, turn the outside connector nut of the load standard (50 Ω) counterclockwise to fully retract the internal connector sleeve.

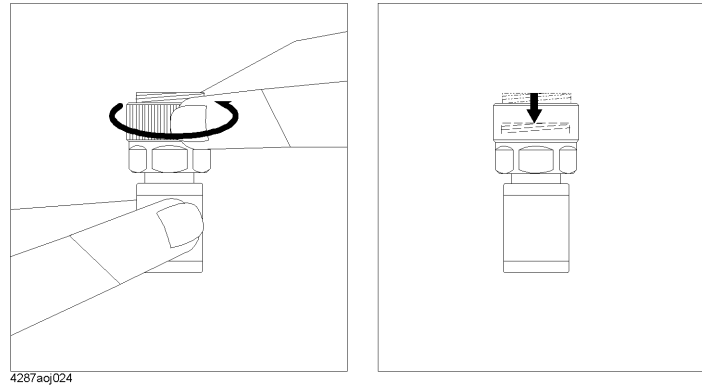

Figure 3-20 **How to retract connector sleeve of load standard**

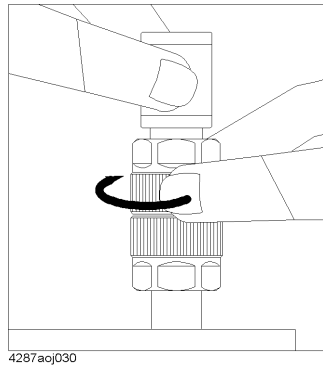

Step 3. While pressing the load standard (50 Ω) from above, turn the connector nut clockwise and securely connect it to the 7-mm terminal (Figure 3-21).

Figure 3-21 **How to connect load standard**



Step 4. Press the  key or  key on the front panel the required number of times to move the cursor to the **Next>** button.

Step 5. Press the  key on the front panel to start measurement of load calibration data. The bar in the Calibration progress indicator in the calibration window indicates the progress of the load calibration data measurement. Upon completion of load calibration data measurement, the screen changes to the next window (Figure 3-22).

Connection of Test Fixture

Connect the test fixture as follows:

Figure 3-22

Test fixture connection window

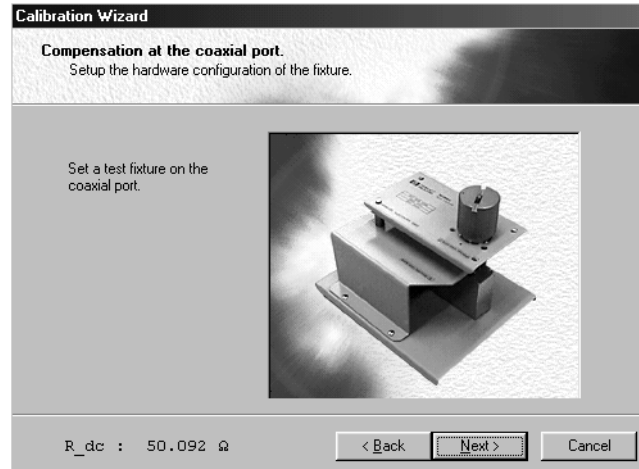

- Step 1.** Turn the connector nut of the low-loss capacitor counterclockwise and remove it from the 7-mm terminal.
- Step 2.** Turn the connector nut of the 7-mm connector counterclockwise to retract the connector sleeve completely inside (Figure 3-23).

Figure 3-23

Retracting the 7-mm connector connector sleeve

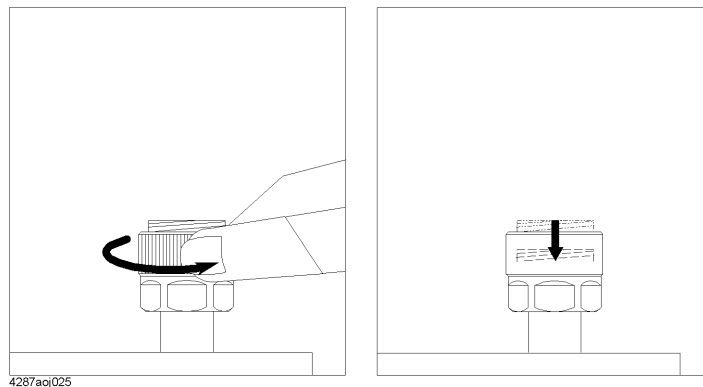



- Step 3.** Fit the tips of the two mounting posts on the test fixture stand to the two holes of the test fixture and fit the 7-mm connector on the test fixture stand to the 7-mm connector on the test fixture. Turn the connector nut of the 7-mm connector on the test fixture stand counterclockwise, as viewed from above, and firmly lock it to the test fixture's 7-mm connector.

Figure 3-24

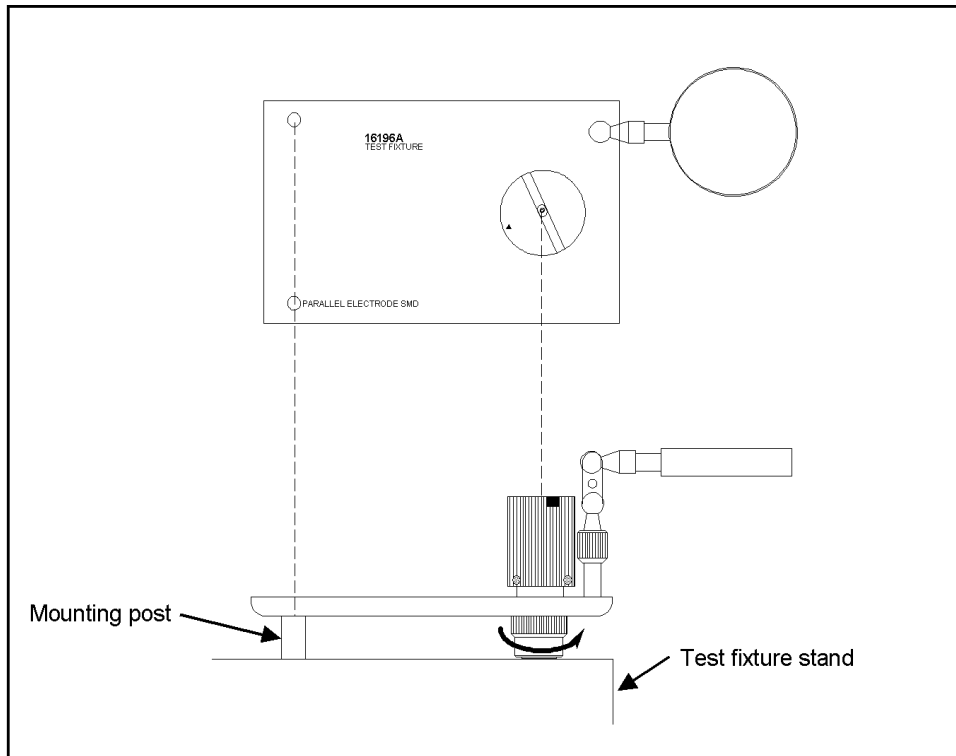
How to install test fixture on test fixture stand



4287aoe026

Step 4. Press the  key or  key on the front panel the required number of times to move the cursor to the **Next>** button.



Step 5. Press the  key on the front panel to move to next window (Figure 3-25).

Executing short compensation

Figure 3-25

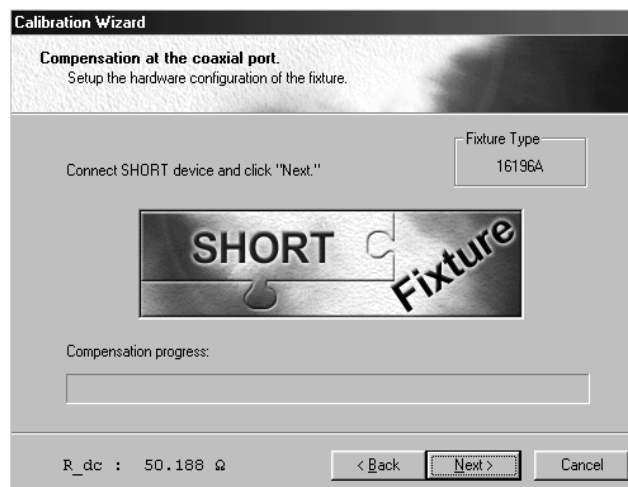
Window for short compensation



- Step 1.** Set the DUT connection terminal of the test fixture to the state in which short compensation is performed. For information on the procedure to set the short state, see the Operation Manual for the test fixture to be used.
- Step 2.** Press the  key or  key on the front panel the required number of times to move the cursor to the **Next>** button.
- Step 3.** Press the  key on the front panel to start measurement of short compensation data. The bar in the Compensation progress indicator in the compensation window indicates the progress of the short compensation data measurement. Upon completion of short compensation data measurement, the screen changes to the next window (Figure 3-26).

Executing open compensation

Figure 3-26

Window for open compensation

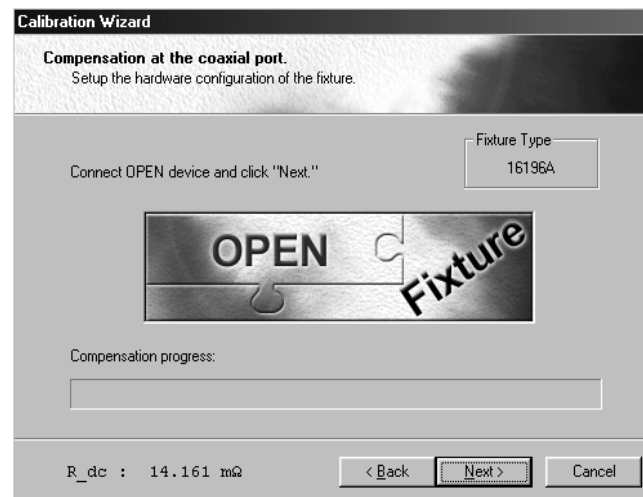







- Step 1.** Set the DUT connection terminal of the test fixture to the state in which open compensation is performed. For information on the procedure to set the open state, see the Operation Manual for the test fixture to be used.
- Step 2.** Press the  key or  key on the front panel the required number of times to move the cursor to the **Next>** button.
- Step 3.** Press the  key on the front panel to start measurement of open compensation data. The bar in the Compensation progress indicator in the compensation window indicates the progress of the open compensation data measurement. Upon completion of open compensation data measurement, the screen changes to the next window (Figure 3-27).

Figure 3-27

Window for closing calibration and compensation wizard

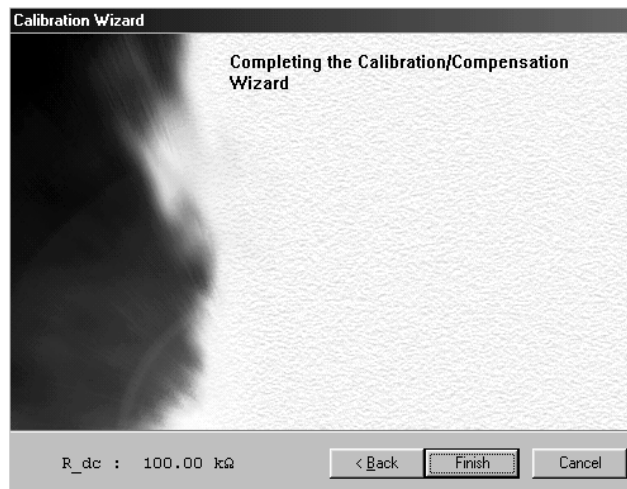

Step 4. Press the  key or  key on the front panel the required number of times to move the cursor to the **Finish** button.

Step 5. Press the  key on the front panel to close the calibration and compensation wizard.

NOTE

Upon completion of calibration and compensation, **Cor**, **Cmp** and **Del** are lit in blue in the equipment status area at the bottom of the display.

Display of DUT Connection and Measurement Result

DUT connection and measurement

Step 1. Connect the DUT according to the Operation Manual for the test fixture.

The measurement result is displayed as shown in Figure 3-28.

Figure 3-28

Measurement result display (measurement point number = 1)

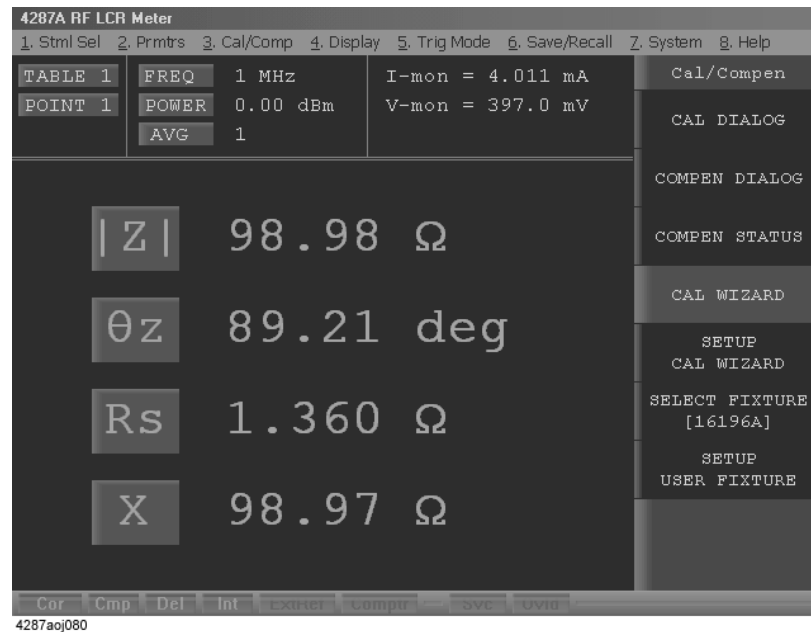

How to change measurement point

In Figure 3-28, the measurement result is only displayed for the 1-MHz point among the four measurement points (1 MHz, 10 MHz, 100 MHz and 1 GHz) set according to “How to set the measurement point (frequency/averaging factor/oscillator level)” on page 54.

Follow these steps to change the measurement point on which you want to perform measurements and display results.

- Step 1.** Press the **[Stml Select]** key on the measurement block (MEASUREMENT) of the front panel. The Stml Select softkey menu appears on the right side of the display.
- Step 2.** Turn the rotary knob (⊙) in the navigation block (NAVIGATION) on the front panel to move the cursor in the softkey menu to the **POINT No.[]** key.
- Step 3.** Press the rotary knob (⊙) to display the POINT No.[] softkey menu on the right side of the display.
- Step 4.** Turn the rotary knob (⊙) to move the cursor in the softkey menu to the softkey corresponding to the desired measurement point number (**POINT 4** in this case).

Step 5. Press the rotary knob (⊙) to accept the selection of the measurement point number (Figure 3-29).

Figure 3-29

Measurement point changed to measurement point number 4



How to change measurement parameters

Set which of the four measurement parameters is to appear on the display by following these steps.

- Step 1.** Press the **[Prmtr]** key on the measurement block (MEASUREMENT) of the front panel. The measurement parameter selection menu appears in the softkey area on the right side of the display.
- Step 2.** Turn the rotary knob (⊙) to move the cursor in the softkey menu to the **SETUP MEAS PRMTRS** key.
- Step 3.** Press the rotary knob (⊙) to display the SETUP MEAS PRMTRS softkey menu on the right side of the display.
- Step 4.** Turn the rotary knob (⊙) to move the cursor in the softkey menu to the softkey corresponding to the measurement point number whose measurement parameters should be changed (**PRMTR-1 []** in this case).
- Step 5.** Press the rotary knob (⊙) to display the PRMTR-1 [] softkey menu on the right side of the display.
- Step 6.** Turn the rotary knob (⊙) to move the cursor in the softkey menu to the softkey corresponding to the desired measurement parameter (**LS** in this case).
- Step 7.** Press the rotary knob (⊙) to accept the selection of the measurement parameter (Figure

3-30).

Figure 3-30

Measurement parameter 1 changed to Ls

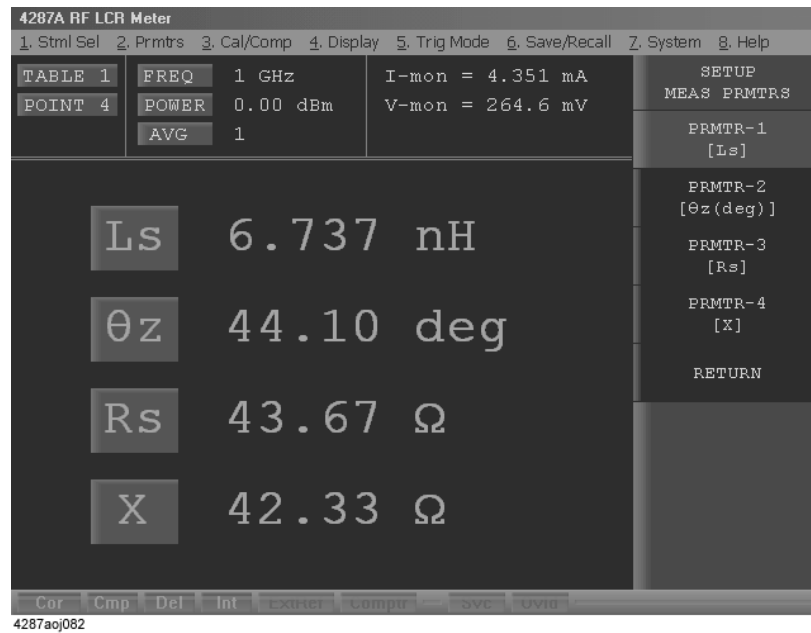

Measurement and display of all set measurement points (list measurement)

In Figure 3-28 on page 69 and Figure 3-29 on page 70, only one of the set measurement points is selected for measurement and display. However, measurement and display can also be executed at all of the set measurement points simultaneously by following this step.

- Step 1.** On the single point measurement display, press the [Meas View] key on the measurement block (MEASUREMENT) of the front panel once to select the list measurement display (Figure 3-31).

3. Learning Basic Operations

Learning Basic Operations
Display of DUT Connection and Measurement Result

Figure 3-31

Display of list measurement

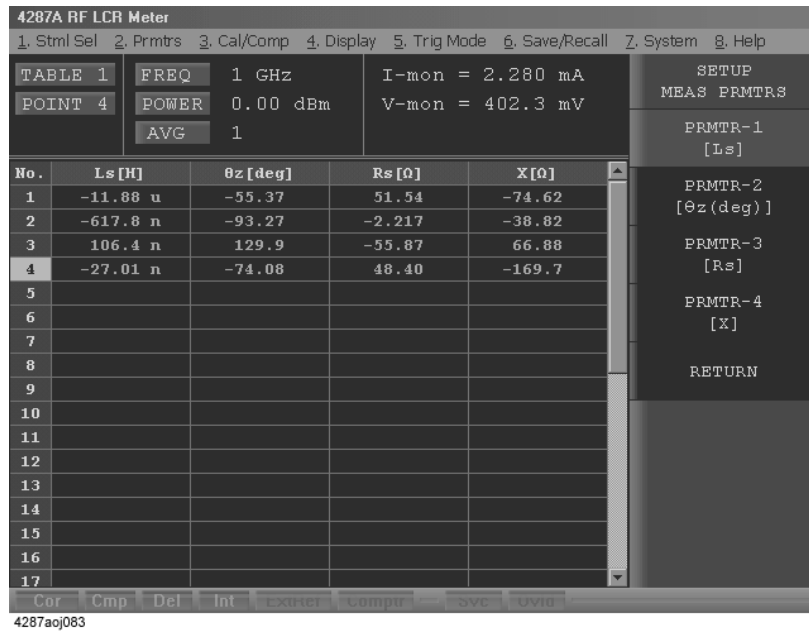

4 Function Overview

This chapter describes the functions of the Agilent Technologies 4287A that can be accessed from the front panel, rear panel, and LCD display.

Names and Functions of Parts on the Front Panel

This section describes the names and functions of the individual parts on the 4287A's front panel.

Figure 4-1

4287A front panel

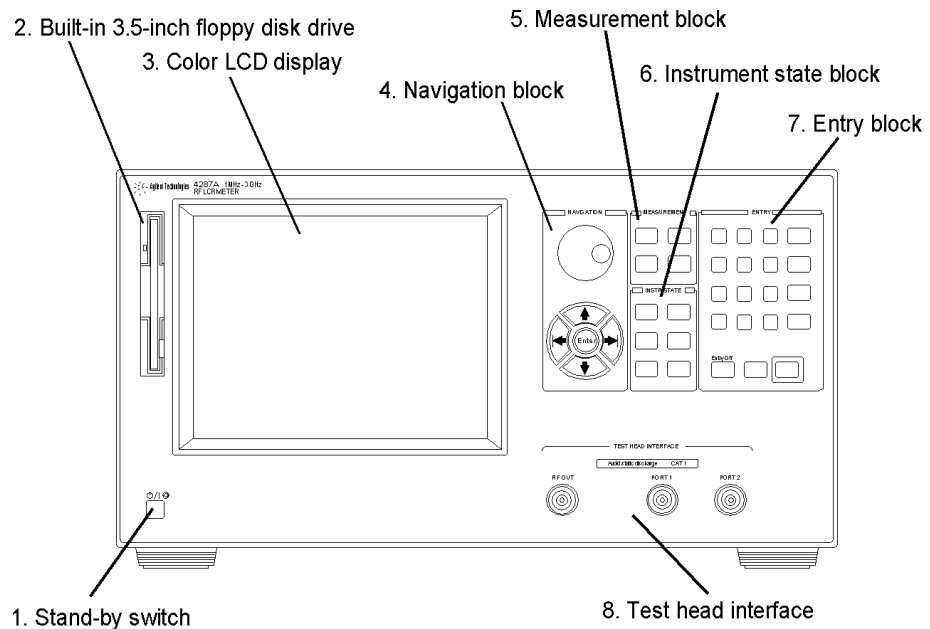

4287a0e002

1. Stand-by switch (⏻)

This is the switch used to turn the power to the 4287A ON and OFF.

NOTE

To turn off the power to the 4287A, be sure to press this switch or send the shutdown command from an external controller to activate the 4287A's shutdown processing of software and hardware used to turn off power. *Never directly turn off the power supply by removing the power cable from the rear panel's power receptacle.*

If the power supply to the power cable receptacle is turned off directly, the shutdown process does not activate and the 4287A software and hardware may be damaged, leading to failure.

For turning the power ON and OFF, see "Turning the Power ON and OFF" on page 38.

2. Built-in 3.5-inch floppy disk drive

This floppy disk drive is used to save the 4287A setup state and measurement data on a floppy disk and to call them up when necessary. It is compatible with a 3.5-inch 720 KB or 1.44 MB DOS formatted floppy disk.

3. Color LCD display

Almost all of the information required for the measurement value, setup state, result of data processing, result of evaluation, menu bar, softkey labels and indications is shown on the color LCD display. This display features an 8.4-inch TFT color screen.

For more on the information appearing on the LCD display, see “Names and Functions of Display Areas on the LCD Display” on page 82.

4. Navigation block (NAVIGATION)

This block contains a group of keys and a knob used to move the cursor position shown on the display and execute the instruction determined by the cursor position. Specifically, the block comprises a rotary knob, arrow keys and an Enter key (gently pressing the rotary knob also performs the Enter function).



(Rotary knob)

Turning the knob clockwise or counterclockwise moves the condition setup cursor (shown as highlighted softkey label or setup table cell outlined by a bold border) vertically. Pressing this knob executes the function indicated by the cursor.



(Arrow keys)

Pressing these keys moves the condition setup cursor vertically or horizontally.



key

Pressing this key executes the function indicated by the cursor. It has the same function as pressing the rotary knob.

5. Measurement block (MEASUREMENT)

This block contains a group of hardkeys for setting up basic measurement conditions.

[Setup View] key

Pressing this key brings up the setup display. The following five setup displays are available: measurement point setup display, calibration kit setup display, compensation kit setup display, bin sort setup display, and other setup display. These five displays can be switched in sequence by repeatedly pressing this key when the setup display is indicated.

[Meas View] key

Pressing this key brings up the measurement display. There are two types of measurement displays: single point measurement display and list measurement display. These two displays can be toggled by pressing this key when the measurement display is indicated.

[Stml Select] key

Displays the Stml Select softkey menu in the softkey area on the right side of the display. These softkeys are used to select the actual measurement point from among the measurement points preset on the softkey measurement point setup display.

[Prmtr] key	Displays the Prmtrs softkey menu in the softkey area on the right side of the display. These softkeys are used to select the measurement parameter.
-------------	---

6. Instrument state block (INSTR STATE)

This block contains a group of hardkeys used to set up the functions to control and manage the comparator, measurement result display, trigger, saving, calling up, and others.

[Cal/Compen] key	Displays the Cal/Compen softkey menu in the softkey area on the right side of the display. This menu is used to execute calibration and compensation.
------------------	---

[Display] key	Displays the Display softkey menu in the softkey area on the right side of the display. This menu is used to specify how to display the measurement results.
---------------	--

[Capture] key	This key uses the same hardkey as the [Display] key. When the key is pressed, an image of the screen at that point in time is copied to the clipboard (temporary memory). This temporarily saved image data can later be named with a filename and saved on a storage device (floppy disk or nonvolatile memory).
---------------	--

[Trigger Mode] key	Displays the Trigger Mode softkey menu in the softkey area on the right side of the display. This menu is used to set the measurement start instruction method (trigger mode).
--------------------	--

[Save/Recall] key	Displays the Save/Recall softkey menu in the softkey area on the right side of the display. This menu is used to save the 4287A setup state and measurement data in a storage device of the 4287A (floppy disk or nonvolatile memory) and to call them up when needed.
-------------------	--

[Trigger] key	This is a manual trigger key. The trigger is activated by pressing this key in the manual trigger mode.
---------------	---

[System] key	Displays the System softkey menu in the softkey area on the right side of the display. This menu is used to control and manage the entire measuring instrument.
--------------	---

7. Entry block (ENTRY)

This block contains a group of hardkeys for entering numerical values and strings of characters. You can operate these keys after moving the cursor to the position where you want to enter numerical values and strings of characters with the keys or the mouse.

[0] through [9][.][-] keys (numeric entry keys)	These keys are used to enter numerical values at the cursor position. You can confirm the setup based on the entered numerical value by subsequently pressing a unit key.
--	---

[G/n][M/μ][k/m] and [×1] keys (unit keys)	Pressing one of these keys after the numerical value is entered by a numeric entry key confirms your entry of the input numerical value assigned to the unit. In other words, these keys execute the setup. Only two prefixes are labeled on the surface of each key, and the selection of the prefix and the type of the unit are automatically determined in conformity with the parameter to be set. The [×1] key allows the setup to be executed without any prefix.
[Alt] key	Pressing this key allows you to use the menu bar at the top of the display screen without using the mouse. Then use the numeric entry keys to enter the menu number you want to select or operate the navigation block keys to your desired menu/submenu.
[Cancel] key	This key uses the same hardkey as the [Alt] key. When a dialog box is displayed and this key is pressed, settings made using this dialog box are cancelled (the key performs the same function as the Cancel key in the dialog box).
[Back Space] key	Use this key to erase one character of the entered character string immediately to the left of the cursor position.
[Preset] key	Use this key to set the 4287A to an initialized state called "Preset state."

8. Test Head Interface (TEST HEAD INTERFACE)

This interface includes the three ports used to connect the test head: RF OUT, PORT 1, and PORT 2. All ports are N-type connectors (female).

NOTE

Do not apply DC voltage or DC current to the test head interface as this could result in damage.

Test Head

The DUT port (see Figure 4-2) corresponds to the IEC61010-1 installation category I.

Figure 4-2

Test Head

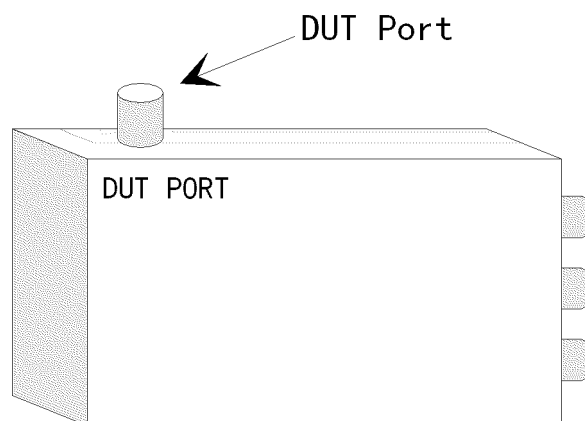

NOTE



To prevent the 4287A from malfunctioning, do not apply DC voltage or DC current to the test head's DUT port. The capacitor in particular could be charged. When you connect a capacitor, discharge it sufficiently before connecting it to the test fixture that is connected to the test head's DUT port.

Names and Functions of Parts on the Rear Panel

The following describes the names and functions of the individual parts on the 4287A's rear panel.

Figure 4-3 4287A rear panel

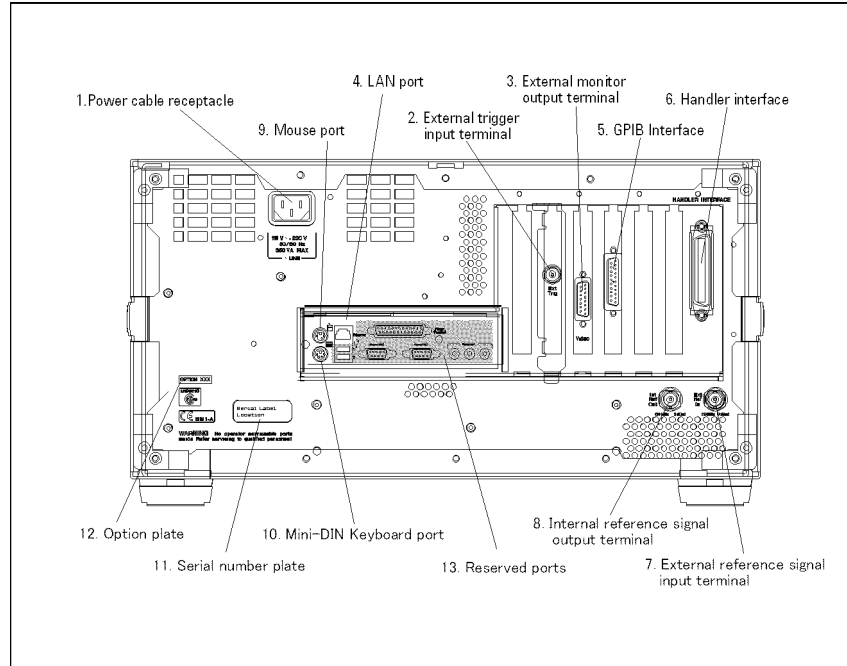

4287a0e10003

1. Power cable receptacle (- LINE)

This is the receptacle used for connecting the power cable. For the requirements of its use, see “Check the power supply” on page 35.

NOTE

Only use the three-wire grounded power cable provided with the instrument. For details, see “4. Navigation block (NAVIGATION)” on page 75.

2. External trigger input terminal (Ext Trig)

Connector type: BNC connector (female)

This terminal allows you to input a trigger signal to execute a measurement command. The rising edge (or falling edge) from the LOW state (or HIGH state) in the TTL compatible signal is detected as a trigger by this external trigger input terminal. To trigger measurements by inputting signals into this terminal, it is necessary to set a trigger source in the EXTERNAL (external trigger input terminal) in advance. For details on the input signal conditions of this terminal, please refer to Chapter 12, “Specifications and Supplemental Performance Characteristics,” on page 251.

3. External monitor output terminal (VIDEO)

Connector type: 15-pin VGA connector

This terminal is used for connecting to an external color monitor (display unit). Connection of a color monitor through this terminal permits the same information shown on the 4287A's LCD display to be displayed on the external monitor.

4. LAN port

Connector type: RJ-45J UTP*¹ LAN connector

This port is used for connecting the 4287A to a LAN (Local Area Network). For how to use LAN features, see the *Programming Manual*.

5. GPIB connector

This is a GPIB (General Purpose Interface Bus) connector. Use together with the GPIB adapter. You can build an automatic measurement system by connecting the external controller and other equipment through this connector. For how to use GPIB-based automatic measurement, see the *Programming Manual*.

6. Handler interface

This interface is used for exchanging data with automatic equipment (handler) in a production line.

7. External reference signal input terminal (Ext Ref In, 10 MHz 0 dBm)

Connector type: BNC connector (female)

This is a signal input terminal for phase-locking the 4287A test signal to an external frequency reference signal. You can improve the accuracy of the 4287A test signal frequency by inputting an external frequency reference signal to this terminal. Accordingly, the 4287A test signal becomes automatically phase-locked to its reference signal. If signal input is discontinued, the 4287A internal frequency reference signal is automatically used.

8. Internal reference signal output terminal (Int Ref Out)

Connector type: BNC connector (female)

This is an internal reference signal output terminal for the 4287A.

If you connect between this output terminal and an external reference signal input terminal of other equipment, you can use the external equipment by phase-locking with the 4287A reference signal.

9. Mouse port (MOUSE)

This port is for connection of a PS/2 compatible mouse with a Mini-DIN connector. Use of the mouse allows you to freely move the arrow cursor on the 4287A LCD display and to

*1. Unshielded Twisted Pair

effectively perform a great variety of setups.

NOTE

An USB mouse is not supported. Use of a mouse other than the specified one may lead to operation error. Be sure to only use the mouse provided by Agilent Technologies.

When using a mouse connected to the 4287A, only click the left mouse button. Consequently, expressions such as “click xxx using the mouse” used in this Manual mean that you have to press the left mouse button.

10. Mini-DIN keyboard port (KYBD)

This port is for connection of a Mini-DIN type keyboard. Use of the keyboard ensures effective entry of numerical values and character strings.

NOTE

Use of a keyboard other than the specified one may lead to operation error. Be sure to only use the keyboard provided by Agilent Technologies.

11. Serial number plate

This seal indicates the product serial number (manufacturing number).

12. Option plate

This seal indicates the options installed on the product.

13. Reserved ports (Reserved)

These ports are not available for use.

Names and Functions of Display Areas on the LCD Display

The 4287A LCD display screens include the six types of displays (two measurement displays and four setup displays) explained in Table 4-1.

Table 4-1 **Types of 4287A displays**

Display type		Function
Measurement display	Single-point measurement display	Measurement is done at the specified single measurement point and the result is shown on this display.
	List measurement display	All measurements are preset in the specified table according to the sequence of the measurement point numbers and are listed on the display.
Setup display	Measurement point setup display	A display for setting up measurement points. The required measurement points are set sequentially, starting from measurement point number 1, by inputting measurement conditions (measurement frequency, averaging factor and test signal level). A maximum of 32 measurement points can be set in each of the eight tables.
	Calibration kit setup display	A display for setting up the calibration kit definition (value) for the measurement point set up on the measurement point setup display.
	Compensation kit setup display	A display for setting up the compensation kit definition (value) for the measurement point set up on the measurement point setup display.
	Bin sorting setup display	A display for setting up the conditions for bin sorting (sorting by measurement result).

Figure 4-4 Switching of six 4287A displays

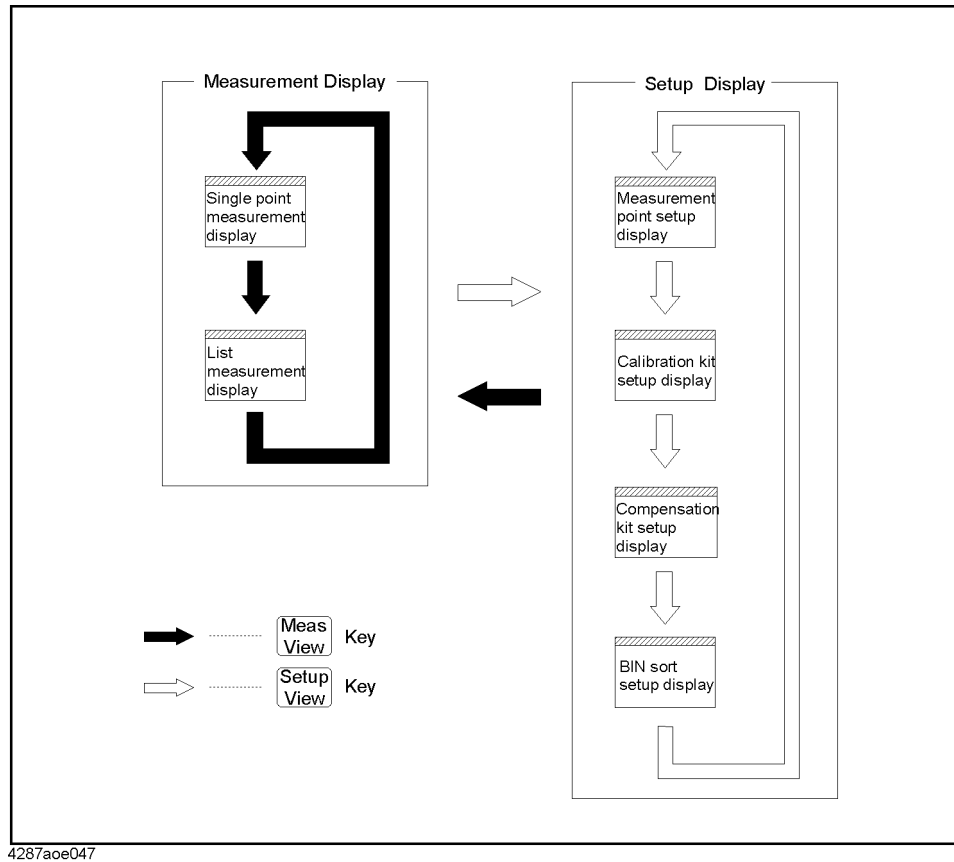

Single point measurement display

The single point measurement display shown in Figure 4-5 appears when you press the [Meas View] key once or twice.

Figure 4-5 Single point measurement display

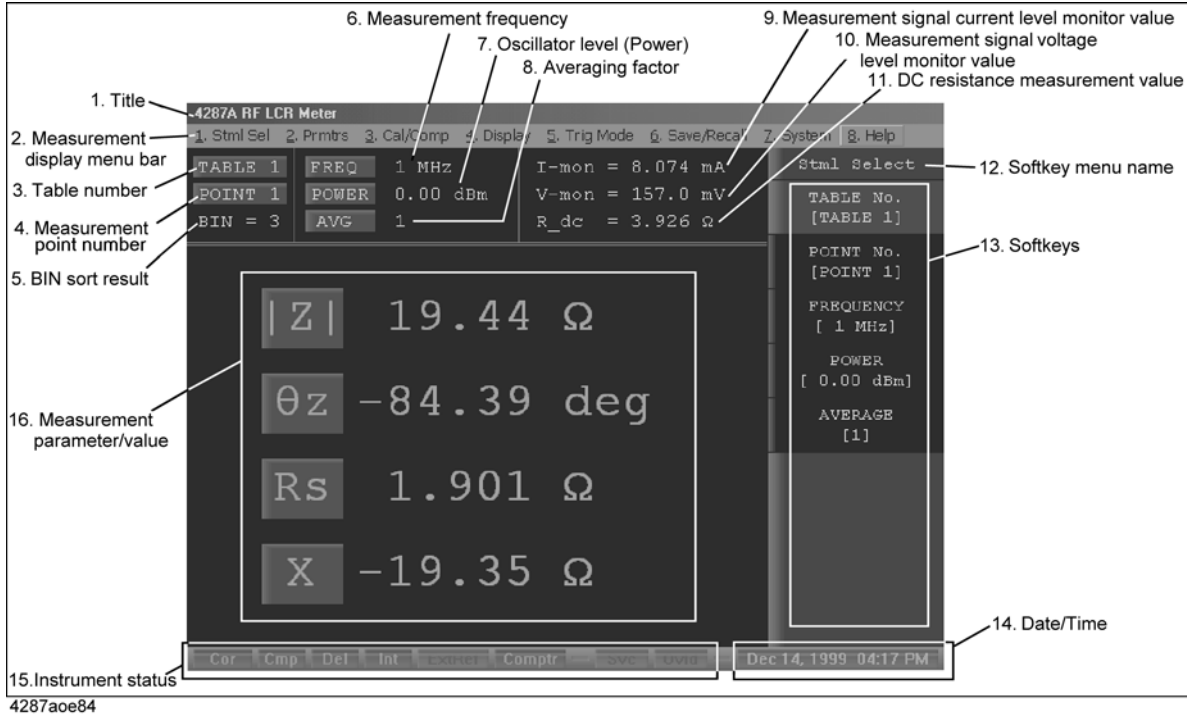





1. Title



The user can enter his or her desired title to be displayed in this position.

2. Measurement display menu bar

This menu bar can be used to perform and execute the same operations as those performed with the [Stml Select] key and [Prmtr] key on the front panel of the 4287A, the keys in the instrument state block (INSTR STATE), and the softkeys shown in the right side of the screen.

This menu bar can be operated according to any one of the following methods:

- Click the menu name using the **mouse** connected to the 4287A and select the desired function from the menu using the mouse.
- Press the [Alt] key of the entry block (ENTRY) on the **front panel** to activate the menu bar and perform any of the following operations (or combined operations):
 - Enter the menu name number using the numeric entry keys ([0] to [9]) to select the desired function.
 - Move the cursor on the menu using the arrow keys     of the navigation block and press the  key to select the desired function. Alternatively,

you can turn the rotary knob  instead of pressing the   keys and then press the rotary knob.

- Activate the menu bar by pressing the **[Alt]** key of the **keyboard** connected to the 4287A and perform any of the following operations (or combined operations):
 - Enter the menu name number using the numeric entry keys (**[0]** to **[9]**) of the keyboard to select the desired function.
 - Move the cursor on the menu using the arrow keys (**[↑]**, **[↓]**, **[←]** and **[→]**) of the keyboard and then press the **[Enter]** key to select the desired function.

NOTE

You can release the state by again pressing the menu bar that was activated by pressing the **[Alt]** key on the front panel or keyboard.

For the measurement display menu bar, despite whether one point measurement display or list measurement display is shown, the function (menu contents) does not change (common).

3. Table number

Displays the currently selected table number. The 4287A has eight tables that each allow a maximum of 32 measurement points to be set. Use the “Measurement point setup display” on page 91 to set the measurement point conditions (measurement frequency, averaging factor, oscillator level for the measurement point number) for each table.

NOTE

To directly call up the table number selection softkey menu, use the mouse to click in the table number area.

4. Measurement point number

Displays the currently selected measurement point number. Use the “Measurement point setup display” on page 91 to set the measurement point conditions (measurement frequency, averaging factor, oscillator level for the measurement point number) for each table.

NOTE

To directly call up the measurement point number selection softkey menu, use the mouse to click in the measurement point number area.

5. BIN sort result

When the BIN sort function is turned ON, the sorting result (BIN number) based on the measurement results is displayed at this position. For the BIN sort function, see Chapter 8, “Sorting According to Measurement Results,” on page 171.

6. Measurement frequency

Indicates the measurement frequency of the currently selected measurement point. The conditions (measurement frequency of measurement point, averaging factor, oscillator level for the measurement point number) for the measurement points of each table are set in “Measurement point setup display” on page 91.

NOTE

To directly call up the FREQUENCY softkey menu, click in the measurement frequency area with the mouse. You can use this softkey menu to select the measurement point by the measurement frequency instead of the measurement point number.

7. Oscillator level (power)

Displays the oscillator level of the currently selected measurement point. Use the “Measurement point setup display” on page 91 to set the measurement point conditions (measurement frequency, averaging factor, oscillator level for the measurement point number) for each table.

NOTE

To directly call up the POWER softkey menu, click in the oscillator level area with the mouse. You can use this softkey menu to select the measurement point by the oscillator level instead of the measurement point number.

8. Averaging factor

Displays the measurement averaging factor of the currently selected measurement point. Use the “Measurement point setup display” on page 91 to set the measurement point conditions (measurement frequency, averaging factor, oscillator level for the measurement point number) for each table.

NOTE

To directly call up the AVERAGE softkey menu, click in the averaging factor area with the mouse. You can use this softkey menu to select the measurement point by the averaging factor instead of the measurement point number.

9. Test signal current level monitor value

Displays the monitor value for the current level applied to the DUT in the present measurement.

10. Test signal voltage level monitor value

Displays the monitor value for the voltage level applied to the DUT in the present measurement.

11. DC resistance (Rdc) measurement value

When the DC resistance (Rdc) measurement function is ON, this measurement result is indicated here.

A limit for making “pass or fail” judgment can be set for the DC resistance (Rdc) measurement result, and this can be used for checking the contact condition of the measurement electrodes and the DUT in the case of impedance measurement.

NOTE







Because the 4287A's DC resistance (Rdc) measurement function utilizes a two-terminal method, it is unsuitable for low resistance measurement.

12. Softkey menu name

Displays the generic softkey menu name for a set of the softkeys described in “13. Softkeys” area.

13. Softkeys

The softkeys are shown here. To operate the softkeys, first press the **[Stml Select]** key or the **[Prmtr]** key described in “5. Measurement block (MEASUREMENT)” on page 75, or the keys described in “6. Instrument state block (INSTR STATE)” on page 76 to call up the desired softkey menu. Then select the desired softkey using any of the following methods:

- ❑ Turn the rotary knob  on the **front panel** clockwise or counterclockwise to vertically move the selection cursor over the softkey label. Then press the rotary knob to select the softkey.
- ❑ Press the   keys on the **front panel** to vertically move the selection cursor over the softkey label. Then press  to select the softkey.
- ❑ Click the softkey label with the **mouse** connected to the 4287A.
- ❑ Press the arrow keys () and () of the **keyboard** connected to the 4287A to vertically move the selection cursor over the softkey label. Then press the **[ENTER]** key to select the softkey.

14. Date/time

Displays the current date and time. For details on how to set the date and time (including turning the indication on or off), see “Initial Registration of 4287A” on page 40.

15. Equipment status

Displays the status of crucial operating conditions of the 4287A.

Display	Definition
UnCal (red display)	Calibration not executed.
Cor (blue display)	Calibration executed.
Cmp (blue display)	Compensation executed.
Del (blue display)	Fixture compensation (electrical length and delay time compensation) has been set (a value other than 0 has been set for the electrical length of the fixture).
Int (blue display)	The trigger mode is internal trigger mode (free run). The 4287A itself executes the trigger continuously.
Man (blue display)	The trigger mode is manual trigger mode. Trigger is executed when the [Trigger] key on the front panel is pressed.
Ext (blue display)	The trigger mode is external trigger mode. Trigger is executed by a signal sent through the external trigger input terminal or the handle interface.
Bus (blue display)	The trigger mode is bus trigger mode. Trigger is executed via GPIB or LAN.

Display	Definition
ExtRef (blue display)	The external frequency reference signal is input as described in “7. External reference signal input terminal (Ext Ref In, 10 MHz 0 dBm)” on page 80, and the 4287A test signal is phase-locked to that reference signal.
Comptr (blue display)	Comparator (BIN sort) turned on.
Svc (blue display)	The 4287A is in service mode. The service mode is used for self-diagnosis and repair of the 4287A. This means that you cannot obtain a measurement guaranteed by the specifications. If this indicator is lit during normal use, the instrument may be malfunctioning.
Ovld (red display)	An overload has occurred in the measurement circuit, and the measurement value is not correct. This indicator lights up when the DUT is attached to or detached from the measurement terminals during measurement.

16. Measurement parameter/measurement value

Displays the measurement parameter/measurement value. The 4287A displays a maximum of four measurement values for measurement parameters at one time.

NOTE

The four measurement parameters shown on the single point measurement display are called “measurement parameter 1,” “measurement parameter 2,” “measurement parameter 3,” and “measurement parameter 4” in that order from the top of the display area.

You can directly call up the measurement parameter selection softkey menu by clicking in the measurement parameter area with the mouse. The measurement parameter need not be preset on the measurement point setup display; you can change it freely on the measurement display.

List measurement display

The point measurement display shown in Figure 4-6 appears when you press the **[Meas View]** key once or twice.

Figure 4-6 List measurement display

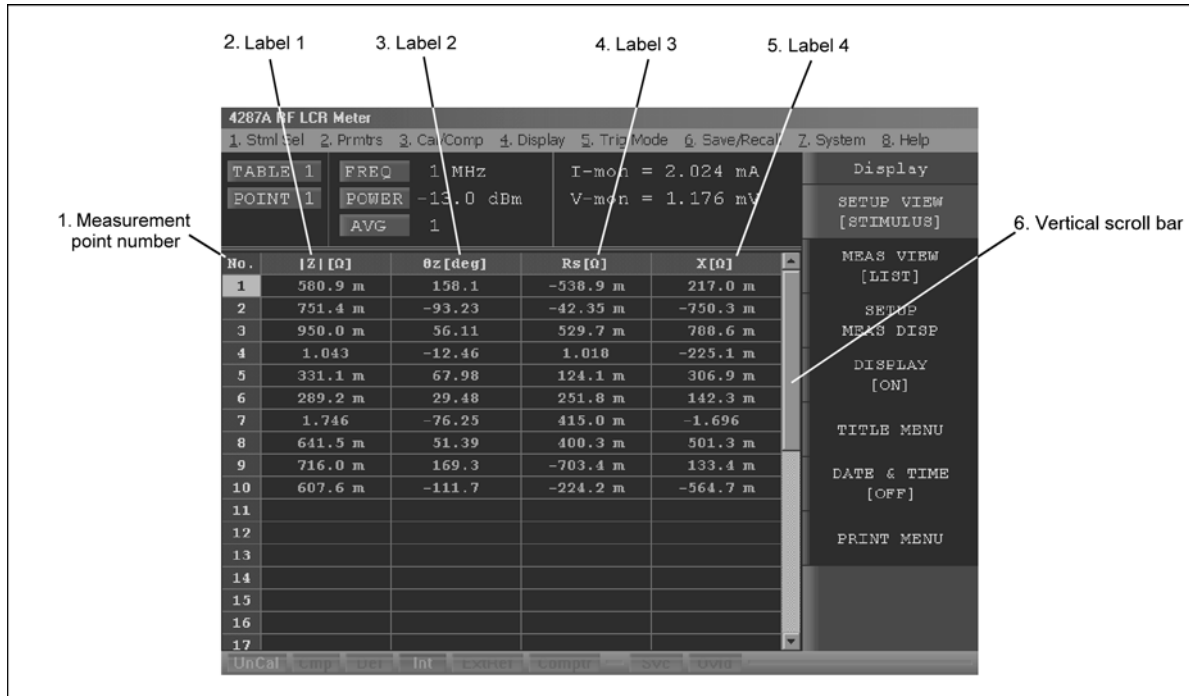

4287ace086

1. Measurement point number

This is the number of the measurement point set in the measurement point setup display. The displayed values of measurement frequency (FREQ), oscillator level (POWER), averaging factor (AVG), test signal current monitor value (I-mon), and test signal voltage monitor value (V-mon) shown in the upper area of the display are for the selected (highlighted) measurement point number.

2 to 5. Labels 1 to 4

You can select one parameter for each of the four labels from among the following and display the parameter's value in the corresponding column.

- Measurement parameter 1 (the top measurement parameter shown in the “Single point measurement display” on page 84),
- Measurement parameter 2 (the second measurement parameter shown in the “Single point measurement display” on page 84),
- Measurement parameter 3 (the third measurement parameter shown in the “Single point measurement display” on page 84),
- Measurement parameter 4 (the bottom measurement parameter shown on the “Single point measurement display” on page 84).
- Test signal voltage monitor value (V-mon)

Names and Functions of Display Areas on the LCD Display

- Test signal current monitor value (I-mon)
- Measurement frequency (FREQ)
- Averaging factor (AVG)
- Test signal level (POWER)
- DC resistance measurement value (Rdc)

6. Vertical scroll bar

You can scroll the table showing the parameters of each measurement point by moving the scroll bar's thumb vertically while keeping the mouse button left-clicked and then releasing it at the desired location. You can also scroll the table by clicking the scroll arrows (▲, ▼) at the ends of the scroll bar or by clicking in the areas in the scroll bar above or below the thumb to move the displayed area one frame up or down, respectively.

NOTE

The same operation applies to the vertical and horizontal scroll bars of the other display screens described in this chapter.

Measurement point setup display

When no dialog box is shown, the measurement point setup display (Figure 4-7) can be displayed by pressing the **[Setup View]** key the required number of times.

Figure 4-7 Measurement point setup display

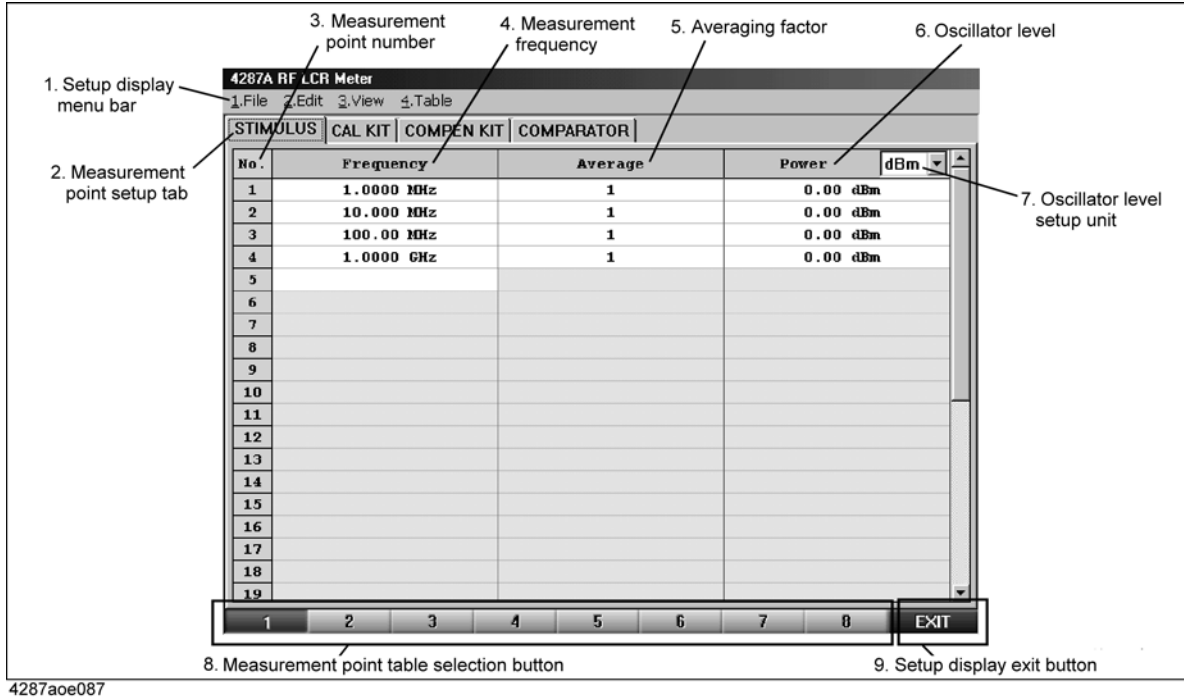

1. Setup display menu bar

The following menus are available on the menu bar of the setup display (the menu bar is shared by all four setup displays).

- 1. File** Used for saving items in the setup table into the 4287A mass storage and for printing.
- 2. Edit** Used for editing the items in the setup table.
- 3. View** Used for setting the display area of setup table.
- 4. Table** Used for selecting the table number.

NOTE

The menu bar operation is the same as that described in “2. Measurement display menu bar” on page 84.

The menu items under each menu remain the same for all setup displays. However, depending on the display, there are some menu functions that cannot be selected; in this case, the name of the menu item is dimmed.

2. Measurement point setup tab

When the “STIMULUS” tab is displayed in front of the other three tabs, the screen shows

the measurement point setup display. If another setup display appears, click this tab with the mouse to get the measurement point setup display. (The same operation can be done with the “View” menu in the menu bar.)

3. Measurement point number

This number indicates the measurement point. Measurement is done in the order of these measurement point numbers as described in “List measurement display” on page 89.

NOTE

Measurement is enabled at the measurement point when the measurement conditions (measurement frequency, averaging factor, oscillator level) are entered.

Measurement points must be set up sequentially starting from point 1.

4. Measurement frequency

Enter the measurement frequency for each measurement point.

5. Averaging factor

Enter the averaging factor for each measurement point.

6. Test signal level

Enter the test signal level for each measurement point.

7. Oscillator level setup unit

Select the unit used for setting as described in “6. Test signal level”. You can select one of the following oscillator level setup units for each table: dBm, V (volt) or A (ampere).

8. Measurement point table selection buttons

Click one of these eight buttons with the mouse to display the contents of the corresponding measurement point table. (The same operation can be done with the “Table” menu in the menu bar.) The currently selected measurement point table is highlighted.

9. Setup display exit button

Click this button with the mouse to close the setup display and return to the measurement display.

NOTE

The “8. Measurement point table selection buttons” and “9. Setup display exit button” displayed at the bottom of the setup display are together referred to as the “tool bar,” which can be toggled between displayed and hidden states with the “ToolBar” menu item in the menu bar’s “View” menu.

Calibration kit setup display

When no dialog box is shown, the calibration kit setup display (Figure 4-8) can be displayed by pressing the **[Setup View]** key the required number of times.

Figure 4-8 Calibration kit setup display

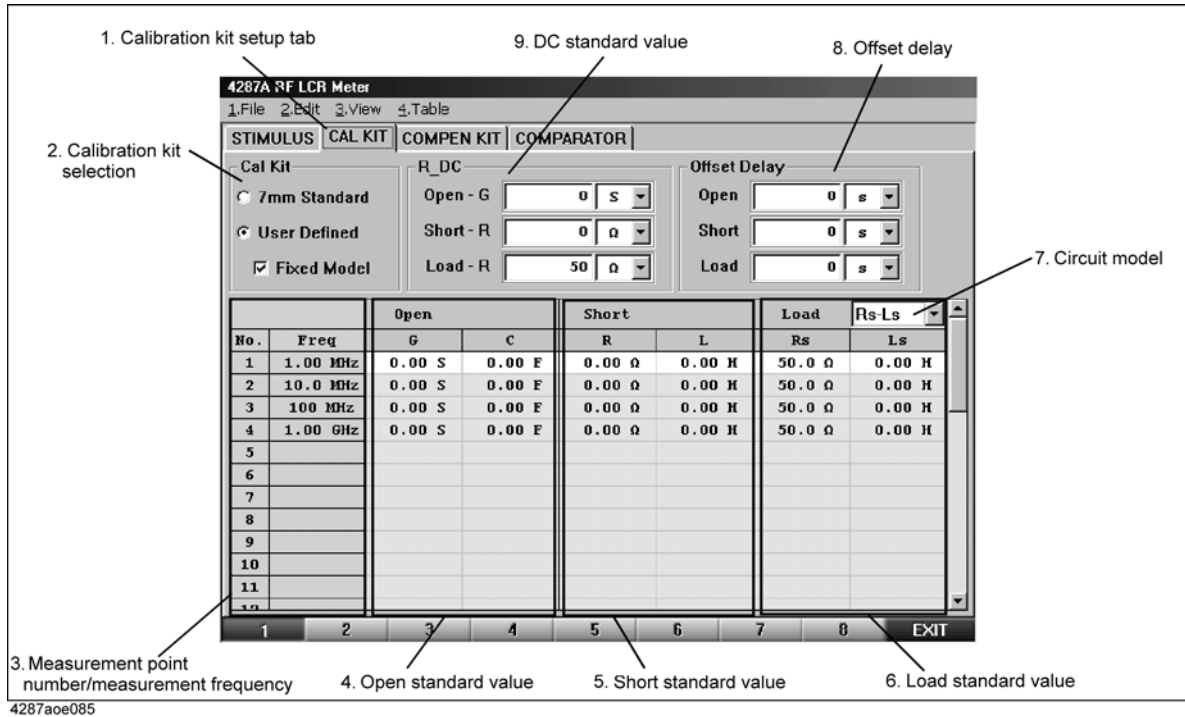

1. Calibration kit setup tab

When the “CAL KIT” tab is displayed in front of the other three tabs, the screen shows the calibration kit setup display. If another setup display appears, click this tab with the mouse to get the calibration kit setup display. (The same operation can be done with the “View” menu in the menu bar.)

2. Calibration kit selection

You can choose whether to use the values predetermined for the 7-mm calibration kit (7-mm standard) or user-defined values as a calibration kit definition. To use the Agilent Technologies 16195B 7-mm calibration kit, select “7 mm Standard.”

Before selecting “7 mm Standard,” all calibration kit values should have been entered; the user is not allowed to change the definition.

If you select “User Defined,” you can freely enter the values for the calibration kit definition. If you check (✓) “Fixed Model,” enter the definition for measurement point number 1, which is then automatically applied to the other measurement point numbers.

3. Measurement point number/measurement frequency

Displays the measurement points (measurement point number and measurement frequency) in the selected measurement point table.

4. Open standard value

Enter the open standard value.

5. Short standard value

Enter the short standard value.

6. Load standard value

Enter the load standard value.

7. Circuit model

Select one of the three circuit models (Rs-Ls, Ls-Q, or Cp-D) for the load parameter.

8. Offset delay

Depending on the calibration kit used, offset delay may have to be set. In this case, enter the offset delay values for open standard, short standard, and load standard.

9. DC standard value

Enter the calibration kit definition for 4287A DC resistance (Rdc) measurement.

Compensation kit setup display

When no dialog box is shown, the compensation kit setup display (Figure 4-9) can be displayed by pressing the **[Setup View]** key the required number of times.

Figure 4-9 Compensation kit setup display

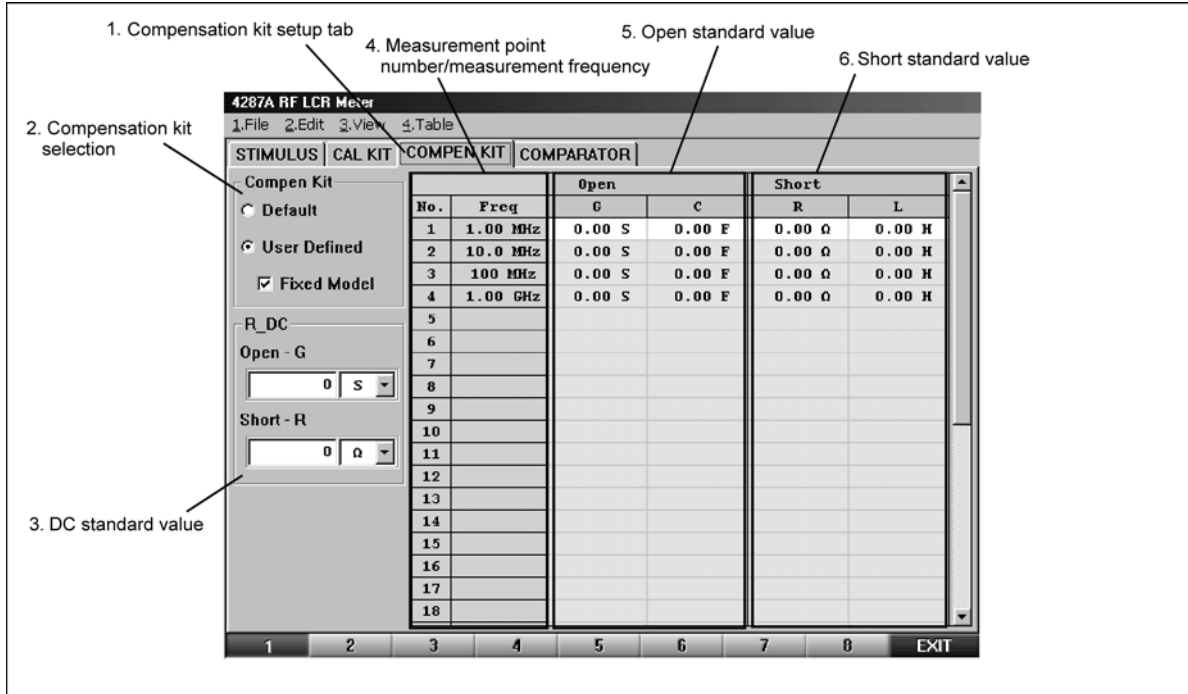

1. Compensation kit setup tab

When the “COMPEN KIT” tab is displayed in front of the other three tabs, the screen shows the compensation kit setup display. If another setup display appears, click this tab with the mouse to get the compensation kit setup display. (The same operation can be done with the “View” menu in the menu bar.)

2. Compensation kit selection

You can choose whether to use the values predetermined for the 7-mm compensation kit (default) or user-defined values as a compensation kit definition.

Before selecting “Default,” all compensation kit values should have been entered; the user is not allowed to change the definition.

If you select “User Defined,” you can freely enter the values for the compensation kit definition. If you check (√) “Fixed Model,” enter the definition for measurement point number 1, which is then automatically applied to the other measurement point numbers.

3. Measurement point number/measurement frequency

Displays the measurement point (measurement point number and measurement frequency) in the selected measurement point table.

4. Open standard value

Enter the open standard value.

5. Short standard value

Enter the short standard value.

6. DC standard value

Enter the compensation kit definition for 4287A DC resistance (R_{dc}) measurement.

Bin sorting setup display

When no dialog box is shown, the BIN sorting setup display (Figure 4-10) can be displayed by pressing the **[Setup View]** key the required number of times.

Figure 4-10 Bin sorting setup display

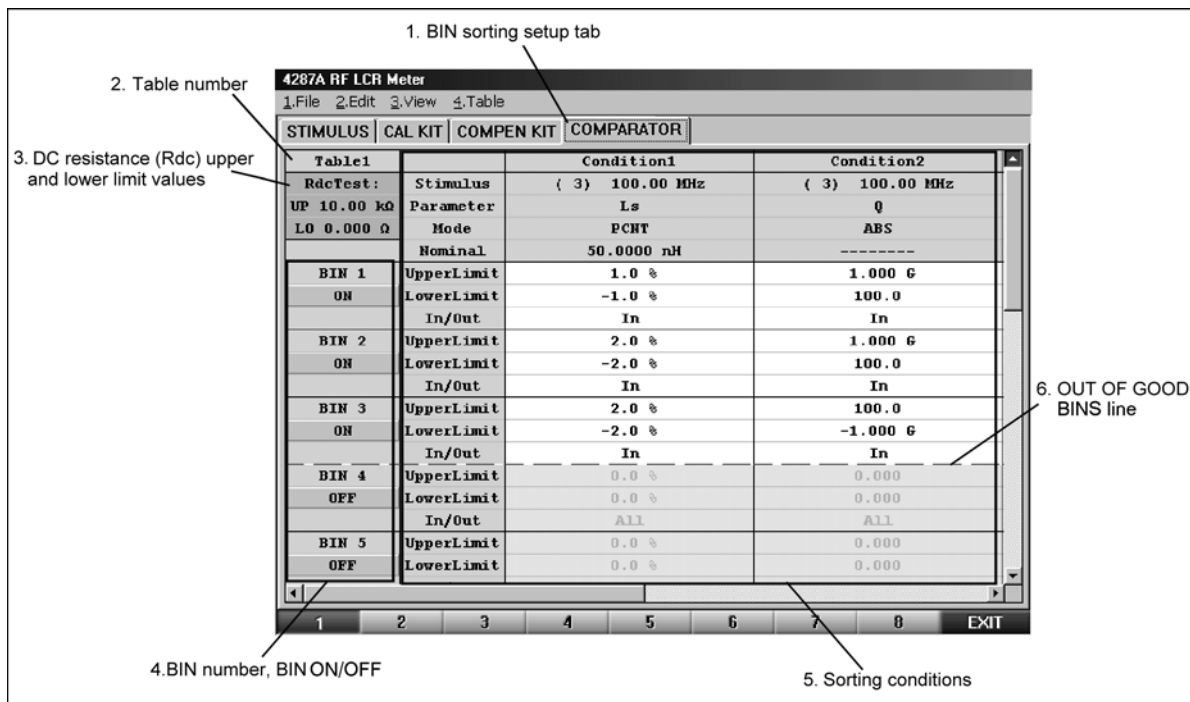

4287a0e089

1. Comparator (bin sorting) setup tab

When the “COMPARATOR” tab is displayed in front of the other three tabs, the screen shows the bin sorting setup display. If another setup display appears, click this tab with the mouse to get the bin sorting setup display. (The same operation can be done with the “View” menu in the menu bar.)

2. Table number

Displays the currently selected table number.

3. DC resistance (Rdc) upper and lower limit values

You can set the upper and lower limit values for the DC resistance (Rdc) measurement result.

4. BIN number, BIN ON/OFF

Use this button to set the bin number and On/Off state. You can set the conditions for sorting parts into a maximum of 13 bins. If you turn off a bin, the bin is regarded as non-existent.

5. Sorting conditions

This area is used to set the sorting conditions for each bin. Four sorting conditions are applied to each bin, and the components that meet all four of a bin's conditions are sorted into that bin.

NOTE

The columns for only two sorting conditions are visible at one time in the bin sorting setup display. To check the columns for the two hidden sorting conditions, use the horizontal scroll bar or move the cursor until they appear.

6. OUT OF GOOD BINS line

This line can be placed at the desired BIN boundary. To position this line, choose the Bin number (indicating the last Good Bin) from the "Out of Good Bins" sub-menu under the tool bar's "Edit" menu. Components sorted into BINs below this line are judged as OUT OF GOOD BINS. The OUT OF GOOD BINS judgment result can be confirmed when the display color of the item "5. BIN sort result" on page 85 (in the single point measurement display, Figure 4-5) changes to red. This signal is also output to the handler interface.

4287A Key Operation Overview

Table 4-2 shows the 4287A key operation list.

Table 4-2 4287A key operation list













Operation	Front panel			External device	
	 (Rotary knob)	 (Arrow keys)	MEASURE- MENT/INSTR STATE/ENTRY block keys	Keyboard	Mouse
Direct switching between measurement/setup displays	(Disabled) ^{*1}	(Disabled) ^{*1}	Press [Setup View] and [Meas View]	(Disabled) ^{*1}	(Disabled) ^{*1}
Direct calling up of softkey top menu	(Disabled) ^{*1}	(Disabled) ^{*1}	Press [Stim Select] , [Prmtr] , [Cal/Compen] , [Display] , [Trig Mode] , [Save/Recall] and [System] keys	(Disabled) ^{*1}	Click a button in the measurement display when the cursor becomes a human hand icon (Disabled if such a button is not available ^{*1})
Menu bar selection/deselection ^{*2}	(Disabled)	(Disabled)	Press [Alt]	Press [Alt]	Click on menu name
Upward movement of selected position ^{*3}	Turn clockwise	Press 	(Disabled) ^{*4}	Press [↑] ^{*4}	Click on selected item ^{*5}
Downward movement of selected position ^{*3}	Turn counterclockwise	Press 	(Disabled) ^{*4}	Press [↓] ^{*4}	Click on selected item ^{*5}
Leftward movement of selected position ^{*3}	(Disabled)	Press 	(Disabled) ^{*4}	Press [←] ^{*4}	Click on selected item ^{*5}
Rightward movement of selected position ^{*3}	(Disabled)	Press 	(Disabled) ^{*4}	Press [→] ^{*4}	Click on selected item ^{*5}
Entry of numerical value	(Disabled)	(Disabled)	Press [1]-[9][0] [.] and [-]	Press [1]-[9][0] [.] and [-]	(Disabled)
Character entry	(Disabled)	Click on character in character entry window	(Disabled)	Press [A] - [Z] , other non-numerical characters	Click on character in character entry window

Table 4-2 4287A key operation list

Operation	Front panel			External device	
	 (Rotary knob)	 (Arrow keys)	MEASURE- MENT/INSTR STATE/ENTRY block keys	Keyboard	Mouse
Change of unit	Turn clockwise or counterclockwise	Press  	Press [G/n][M/μ] [k/m] and [×1] (also performs execution of entry)	Press [↑][↓]	Click on unit in drop down list ^{*5}
Execution of entry and selection	Press	Press 		Press [Enter]	(Selection is executed by clicking on selected item)

- *1. If you have selected the menu bar with the **[Alt]** key, then you can execute this function from a menu.
- *2. After selection, you can use the arrow keys to change the selected menu and menu item and the rotary knob to change the selected menu item.
- *3. The selected position refers to the highlighted menu name and cell on the display. Subsequent entry or selection will apply to that position.
- *4. In the menu bar, however, you can select the menu by pressing the key for the initial number (alphanumeric) of the menu name heading. The same operation can be done for the numbered menu items within each menu.
- *5. Normally, the function is executed simultaneously with the movement to the selected position (you need not press the  or other key).

5 Setting Measurement Conditions

This chapter describes how to set the measurement conditions, including measurement frequency and averaging, of the Agilent 4287A RF LCR Meter.

The installation of the 4287A must be completed before measurements can be taken. If the installation has not been completed, do this by referring to Chapter 2, “Installation Guide,” on page 17.

How to Preset the 4287A

To return to the initialized state, called the “preset state,” press the [Preset] key at the lower-right corner of the entry block.

NOTE

To ensure correct setting, it is best to preset the 4287A before you start a new setting.

How to Set the Measurement Point

Unlike measuring instruments that allow constant changing of frequency and oscillator levels during measurement, the 4287A requires that all measurement points for subsequent measurements be set before measurement starts. The measurement point is set on the measurement point setup display.

How to bring up the measurement point setup display

You can bring up the measurement point setup display by following this step:

- Step 1.** Press the **[Setup View]** key until the measurement point setup display appears.

Figure 5-1

Measurement point setup display

No.	Frequency	Average	Power	dBm
1	1.0000 MHz	1	-13.0	dBm
2				
3				
4				
5				
6				
7				
8				
9				
10				
11				
12				
13				
14				
15				
16				
17				
18				
19				

NOTE

When you display the measurement point setup display from the setup state for the first time, preset data has already been input for measurement point number 1 of each table (1 to 8), i.e., frequency of 1 MHz, averaging factor of 1, and oscillator level of -13.0 dBm.

When a dialog box (window for making settings) is shown, the setup display is not switched even if the **[Setup View]** key is pressed. In this case, press the **[Cancel]** key on the front panel to close the dialog box before pressing the **[Setup View]** key.

Setting Measurement Conditions

How to Set the Measurement Point

How to specify table number for setup

The 4287A has eight tables that allow a maximum of 32 measurement points to be set. To set the measurement point (or to set the calibration kit, compensation kit, or BIN sort), first specify the table number by following the step below.

NOTE For how to “select the menu from the menu bar” as described in this procedure, see “2. Measurement display menu bar” on page 84.

- Step 1.** Select the **4. Table** menu from the menu bar at the top of the screen and then select the desired table number from the menu (**Table 1** to **Table 8**) (Figure 5-2).

Figure 5-2 Selecting the measurement table from the menu bar

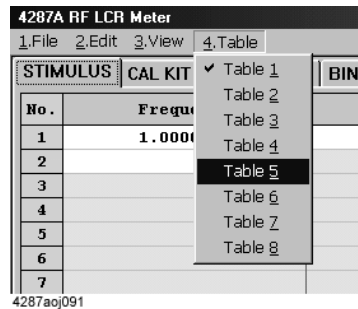

NOTE Instead of using the menu bar, the measurement point table can also be selected by using the mouse to click on the buttons at the bottom of the screen described in “8. Measurement point table selection buttons” on page 92.

How to add measurement points

The measurement point number 1 of each table (1 to 8) has data consisting of a frequency of 1 MHz, averaging factor of 1, and oscillator level of -13.0 dBm as a preset state.

To add new measurement points to those already entered in the specified table, perform the following steps.

- Step 1.** Use the mouse to select the cell one level below the already entered frequency cell (a selected cell is called an active cell; it is enclosed in a thick-bordered box indicating that the cell is selected for data entry (Figure 5-3)).

Figure 5-3

Selection of frequency cell for new measurement point to be added

No.	Frequency	Average	Power
1	1.0000 MHz	1	-13.0 dBm
2			
3			
4			
5			
6			
7			
8			
9			
10			
11			
12			
13			
14			
15			
16			
17			
18			
19			

NOTE

Selectable cells are displayed more brightly than other cells.

- Step 2.** Press the numeric entry keys ([0] to [9] and [.] and a unit key ([G/n], [M/μ], [k/m] or [×1]) in the entry block sequentially to enter the frequency of the measurement point to be added.
- To enter 2 MHz, for example, press [2] (Figure 5-4) and [M/μ] sequentially.

Setting Measurement Conditions

How to Set the Measurement Point

Figure 5-4

Addition of measurement frequency

No.	Frequency	Average	Power	dBm
1	1.0000 MHz	1	-13.0	dBm
2	2 MHz			
3				
4				
5				
6				
7				
8				
9				
10				
11				
12				
13				
14				
15				
16				
17				
18				
19				

4287aaj093

NOTE

If you add frequency as a new measurement point, the same settings of the averaging factor and oscillator level as those of the previous measurement point are automatically input.

If you press the [**×1**] key, **Enter** key, or rotary knob (⊙) on the front panel or the **[Enter]** key on the keyboard after entering the value without specifying the unit, the same unit as that of the above cell is entered as the default value. To change the unit, perform any of the following operations before pressing any of the above keys.

- Press the or key in the navigation block on the front panel the required number of times to change the unit.
- Turn the rotary knob (⊙) in the navigation block on the front panel to the left or right to change the unit.
- Press the [**↑**] or [**↓**] key on the keyboard connected to the 4287A the required number of times to change the unit.
- Using the mouse connected to the 4287A, left-click the down-arrow ▼ to the right of the unit indication, and then select the unit from the pull-down menu that appears.

Step 3. Repeat Steps 1 and 2 to add the required measurement points (Figure 5-5).

Figure 5-5 Example of setting measurement points at intervals of 1 MHz, from 1 MHz to 10 MHz

4287A RF LCR Meter
 1.File 2.Edit 3.View 4.Table

STIMULUS | CAL KIT | COMPEN KIT | COMPARATOR

No.	Frequency	Average	Power	dBm
1	1.0000 MHz	1	-13.0	dBm
2	2.0000 MHz	1	-13.0	dBm
3	3.0000 MHz	1	-13.0	dBm
4	4.0000 MHz	1	-13.0	dBm
5	5.0000 MHz	1	-13.0	dBm
6	6.0000 MHz	1	-13.0	dBm
7	7.0000 MHz	1	-13.0	dBm
8	8.0000 MHz	1	-13.0	dBm
9	9.0000 MHz	1	-13.0	dBm
10	10.000 MHz	1	-13.0	dBm
11				
12				
13				
14				
15				
16				
17				
18				
19				

1 2 3 4 5 6 7 8 EXIT

4287a0j094

Setting Measurement Conditions

How to Set the Measurement Point

How to change frequency of a set measurement point

Change the frequency of an already set measurement point by following these steps:

- Step 1.** Use the mouse to select the frequency cell at the measurement point you want to change.
- Step 2.** Enter a new frequency by pressing the numeric entry keys of the entry block ([0] to [9] and [.] and a unit key ([G/n], [M/μ], [k/m], or [×1]) sequentially.

To enter 5.5 MHz, for example, press [5], [.] and [5] (Figure 5-6) and then [M/μ].

Figure 5-6

How to change frequency of a set measurement point

4287A RF LCR Meter
1.File 2.Edit 3.View 4.Table

STIMULUS	CAL KIT	COMPEN KIT	COMPARATOR
No.	Frequency	Average	Power dBm
1	1.0000 MHz	1	-13.0 dBm
2	2.0000 MHz	1	-13.0 dBm
3	3.0000 MHz	1	-13.0 dBm
4	4.0000 MHz	1	-13.0 dBm
5	5.5 MHz	1	-13.0 dBm
6	6.0000 MHz	1	-13.0 dBm
7	7.0000 MHz	1	-13.0 dBm
8	8.0000 MHz	1	-13.0 dBm
9	9.0000 MHz	1	-13.0 dBm
10	10.000 MHz	1	-13.0 dBm
11			
12			
13			
14			
15			
16			
17			
18			
19			

1 2 3 4 5 6 7 8 EXIT

4287aoj095

How to change averaging factor

Change the averaging factor of an already set measurement point by following these steps:

- Step 1.** Use the mouse to select the averaging factor cell at the measurement point you want to change.
- Step 2.** Enter a new averaging factor by pressing the numeric entry keys of the entry block ([0] to [9]) and [×1]) sequentially.

To set the averaging factor to “10,” for example, press [1] and [0] (Figure 5-7) and then [×1].

Figure 5-7

How to change the averaging factor

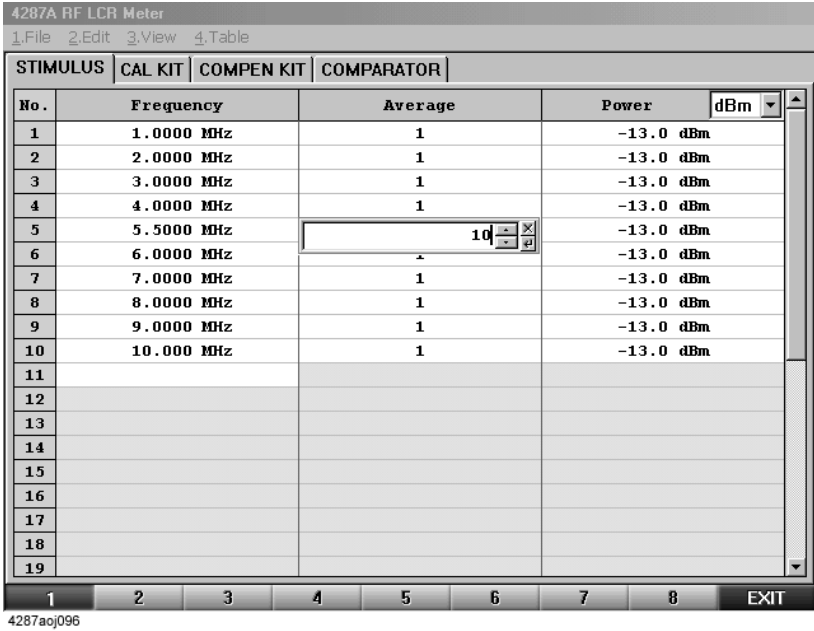

4287a0j096

Setting Measurement Conditions

How to Set the Measurement Point

How to change oscillator level

Change the oscillator level of an already set measurement point by following these steps:

- Step 1.** Use the mouse to select the oscillator level cell at the measurement point you want to change.
- Step 2.** Enter a new oscillator level by pressing the numeric entry keys of the entry block ([0] to [9], [-] and [=] and [×1] sequentially.

To set the oscillator level to -10 dBm, for example, press [-], [1] and [0] (Figure 5-8) and then [×1].

Figure 5-8

How to change oscillator level

4287A RF LCR Meter
1.File 2.Edit 3.View 4.Table

STIMULUS	CAL KIT	COMPEN KIT	COMPARATOR
No.	Frequency	Average	Power dBm
1	1.0000 MHz	1	-13.0 dBm
2	2.0000 MHz	1	-13.0 dBm
3	3.0000 MHz	1	-13.0 dBm
4	4.0000 MHz	1	-13.0 dBm
5	5.5000 MHz	10	-10 dBm
6	6.0000 MHz	1	-13.0 dBm
7	7.0000 MHz	1	-13.0 dBm
8	8.0000 MHz	1	-13.0 dBm
9	9.0000 MHz	1	-13.0 dBm
10	10.000 MHz	1	-13.0 dBm
11			
12			
13			
14			
15			
16			
17			
18			
19			

1 2 3 4 5 6 7 8 EXIT

4287aoj097

How to change oscillator level setup unit

Change the oscillator level setup unit by following these steps:

- Step 1.** Click the mouse in the “Power” column heading to display the menu of the drop-down list box.

NOTE The drop-down list box menu can also be displayed by using the mouse to click the down-arrow ▼ to the right of the Power cell.

- Step 2.** Click on a new unit name from the drop-down list box menu (Figure 5-9).

Figure 5-9 How to change oscillator level setup unit

No.	Frequency	Average	Power	dBm
1	1.0000 MHz	1	-13.0 dBm	dBm
2	2.0000 MHz	1	-13.0 dBm	dBm
3	3.0000 MHz	1	-13.0 dBm	dBm
4	4.0000 MHz	1	-13.0 dBm	dBm
5	5.5000 MHz	10	-10.0 dBm	dBm
6	6.0000 MHz	1	-13.0 dBm	dBm
7	7.0000 MHz	1	-13.0 dBm	dBm
8	8.0000 MHz	1	-13.0 dBm	dBm
9	9.0000 MHz	1	-13.0 dBm	dBm
10	10.000 MHz	1	-13.0 dBm	dBm
11				
12				
13				
14				
15				
16				
17				
18				
19				

As a result, the signal level unit of each measurement point is converted to the selected unit (Figure 5-10).

Setting Measurement Conditions
How to Set the Measurement Point

Figure 5-10

How to change signal level setup units from dBm to V

No.	Frequency	Average	Power	Unit
1	1.0000 MHz	1	100 mV	V
2	2.0000 MHz	1	100 mV	V
3	3.0000 MHz	1	100 mV	V
4	4.0000 MHz	1	100 mV	V
5	5.5000 MHz	10	141 mV	V
6	6.0000 MHz	1	100 mV	V
7	7.0000 MHz	1	100 mV	V
8	8.0000 MHz	1	100 mV	V
9	9.0000 MHz	1	100 mV	V
10	10.000 MHz	1	100 mV	V
11				
12				
13				
14				
15				
16				
17				
18				
19				

4287a0j099

NOTE

The setting resolution of the oscillator level is always 0.1 dB regardless of the set unit. Accordingly, if the oscillator level is entered in V (volt) or A (ampere) units, the set value is automatically converted with 0.1 dB resolution based on the input value.

For example, if you have entered 50 mV as the oscillator voltage level, the value is equivalent to -19.030... [dBm] in dBm units and the 4287A stores the settings as -19.0 dBm. Next, the value -19.0 dBm is converted to V units and the result is 50.178... [mV]. As a result, the displayed value will be 50.2 mV.

Setting up dc resistance (R_{dc}) measurement

Turning ON/OFF

Follow these steps to turn ON/OFF the R_{dc} measurement.

- Step 1.** Press the **[Prmtr]** key on the front panel to display the Prmtrs softkey menu.
- Step 2.** Press the **RDC MEAS []** key on the softkey menu to toggle ON/OFF the R_{dc} measurement.

Softkey label	R _{dc} measurement
RDC MEAS [ON]	ON
RDC MEAS [OFF]	OFF

Turning ON/OFF offset cancel function

NOTE

The offset cancel function is available with the firmware Rev.1.30 or greater.

The 4287A provides the offset cancel function that eliminates offset measurement error (the measured R_{dc} value when the measurement signal is not applied) during measurement that occurs when dc current is superposed on the measurement cable used for measurement.

When the offset cancel function is ON, the R_{dc} measurement is performed in 2 ways, that is, with the measurement signal applied and not applied. After that, the measured value is calculated based on the value obtained by subtracting the measured value when the signal is not applied from the one when the signal is applied.

NOTE

To use the offset cancel function, turn ON the offset cancel function before measuring calibration/compensation data.

Follow these steps to turn ON/OFF the offset cancel function.

- Step 1.** Press the **[System]** key on the front panel to display the System softkey menu.
- Step 2.** Press the **SERVICE MENU** key on the softkey menu to display the SERVICE MENU softkey menu.
- Step 3.** Press the **RDC OFS CANCEL []** key on the softkey menu to toggle ON/OFF the offset cancel function.

Softkey label	Offset cancel function
RDC OFS CANCEL [ON]	ON
RDC OFS CANCEL [OFF]	OFF

Setting Measurement Conditions
Setting up dc resistance (Rdc) measurement

6 Calibration and Compensation

This chapter describes calibration and compensation functions of the Agilent 4287A.

Before starting calibration and compensation, set measurement conditions according to Chapter 5, “Setting Measurement Conditions,” on page 101.

Calibration and Compensation Functions

The following describes the calibration and compensation functions of the Agilent Technologies 4287A.

Types of calibration and compensation functions

The Agilent 4287A has four calibration and compensation functions as shown in Table 6-1.

Table 6-1 Overview of Agilent 4287A RF LCR calibration and compensation functions

Type of calibration and compensation functions	Procedures	Effect
Open/short/load calibration	Connect each of three standards (open/short/load calibration standards) to the desired reference plane (terminal) and measure all of the calibration data ^{*1} . This reference plane is called a calibrated reference plane.	Removes the error factors from the measuring instrument through to the calibration reference plane. To perform calibration at the terminal connected with the DUT, no other calibrations or compensations are necessary.
Low-loss capacitor calibration	Connect a low-loss capacitor ^{*2} to the reference plane for calibration and measure calibration data (immediately after open/short/load calibration). This is possible only when a 7-mm terminal is used as a reference plane for calibration.	Reduces measurement error of high Q (low dissipation factor) at the frequency band of 1 GHz or more where reduction is difficult when done only by open/short/load calibration.
Compensation of port extension (Fixture selection)	Use numerical values to enter the electrical length data from the calibration reference plane subjected to open/short/load calibration through to the connection plane of the DUT. Electrical length data for dedicated test fixtures are already registered in the 4287A, so you can set the required electrical length by simply selecting the model number of the test fixture to be used.	Corrects additional errors resulting from the phase shift occurring between the calibration reference plane and the connection plane of the DUT. When the test head coaxial terminal is used as a reference plane for calibration, this additional compensation must be performed.
Open/short compensation	To connect the DUT to the terminal extended from the calibration reference plane subjected to open/short/load calibration, keep the DUT connection terminal open and measure the open compensation data. Then, short out the terminal and measure the short compensation data. ^{*1}	Removes error factors from the calibration reference plane to the plane subjected to open/short compensation. When the test head coaxial terminal is used as a calibration reference plane, this additional compensation must be performed.

- *1. These calibration data can normally be used to measure DC resistance (Rdc). If required, a dedicated standard can be prepared to perform a separate DC open/short/load calibration to obtain data for measuring DC resistance.
- *2. Included in the “Agilent 16195B 7-mm calibration kit.”

Calibration reference plane and required calibration and compensation

Actual measurement is performed with the desired combinations of calibration and compensation functions given in Table 6-1 on page 116. Basically, either method A or B shown in Table 6-2 is selected, depending on the position of the calibration reference plane.

Table 6-2 Calibration reference plane and required calibration and compensation

Calibration reference plane	Required calibration and compensation	Position and method
A. Coaxial terminal of test head*1	Open/short/load calibration	For this calibration, connect a coaxial compensation kit*2 to the test head coaxial terminal (used as a calibration reference plane).
	low-loss capacitor calibration (only when high-accuracy high-Q measurement or low dissipation factor calibration is required at about 1 GHz or more)	For this calibration, connect a low-loss capacitor to the calibration reference plane.*3
	Port extension compensation (fixture selection)	Enter the electrical length data from the calibration reference plane through to the sample connection plane into the Agilent 4287A.*4
	Open/short compensation	For this compensation, keep the DUT connection terminal open or shorted out.
B. DUT connection terminal	Open/short/load calibration	For this calibration, connect a working standard*5 to the DUT connection terminal (used as a calibration reference plane).

- *1. Indicates the 3.5-mm terminal of the test head or one equipped with an adapter.
- *2. Includes Agilent 16195B 7-mm calibration kit.
- *3. Since the low-loss capacitor is designed as a 7-mm type capacitor, calibration is possible only when the calibration reference plane uses a 7-mm connector.
- *4. When you use a dedicated test fixture with a registered electrical length, you simply have to select the fixture model number.
- *5. A reference device valued at the same contour as the DUT. Option 004 (working standard set) or similar can be used.

NOTE No calibration or compensation other than open/short/load calibration is required when the DUT connection terminal is used as a calibration reference plane (B in Table 6-2).

Calibration and Compensation

Calibration and Compensation Functions

Figure 6-1 and Figure 6-2 show the relationship between the calibration reference plane used and the required calibration/compensation.

Figure 6-1

Calibration and compensation when test head coaxial terminal is used as calibration reference plane

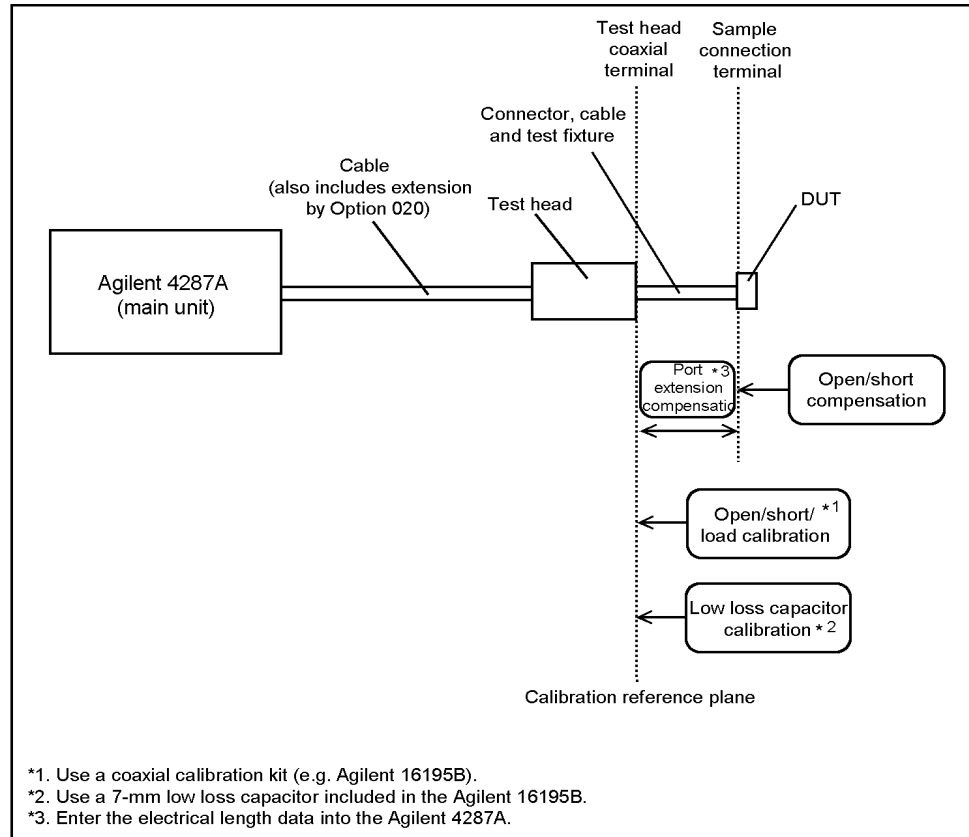

4287aoj014

Figure 6-2

Calibration when DUT connection terminal is used as calibration reference plane

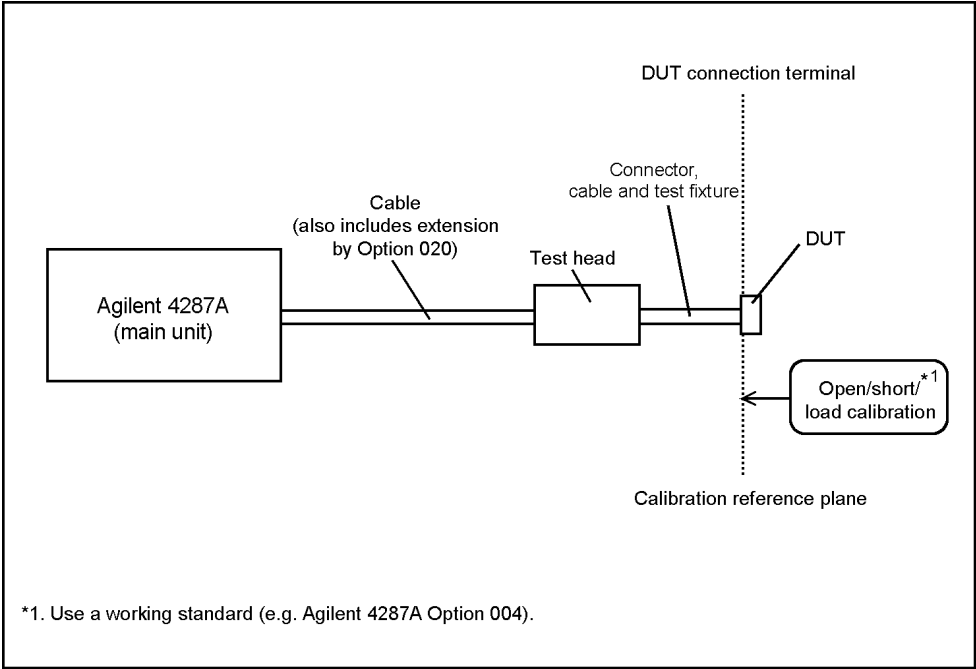

4287aoj013

Calibration and Compensation Procedures Using Dedicated Test Fixture

The following describes the calibration and compensation procedures to measure the DUT by connecting the Agilent 4287A test head to a dedicated test fixture (e.g. Agilent 16196A) with a 3.5-mm-to-7-mm adapter and a test fixture stand, as illustrated in Figure 6-3.

Figure 6-3

Measuring a DUT with dedicated test fixture directly coupled to test head

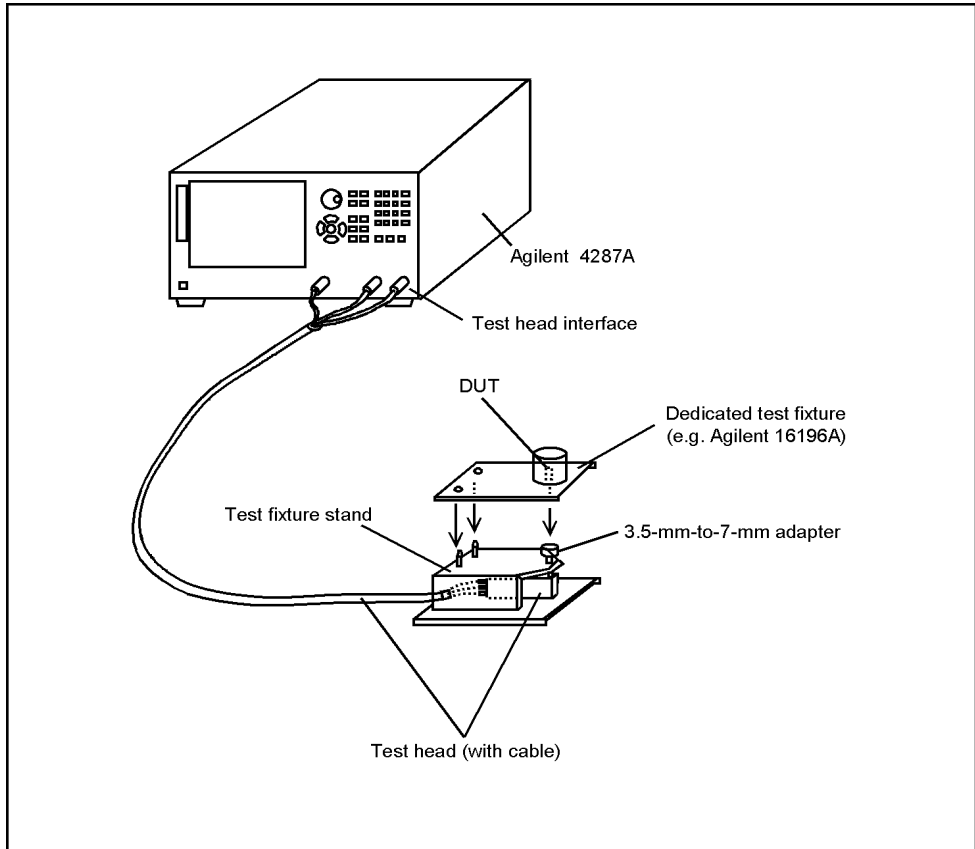

4287aoj012

1. Test head coaxial terminal used as calibration reference plane

The following describes the calibration and compensation procedure with a dedicated test fixture when the test head coaxial terminal is used as a calibration reference plane. In this case, the coaxial terminal serving as a calibration reference plane is generally a 7-mm terminal connected by a 3.5-mm-to-7-mm adapter. The calibration and compensation shown in Table 6-3 are carried out in the specified sequence.

Table 6-3 Calibration and compensation using test head coaxial terminal (7 mm) as a calibration reference plane

Required calibration	Position to be calibrated	Standard used
Open/short/load calibration *1	7-mm test head terminal (used as calibration reference plane)	A 7-mm calibration kit such as 16195B
Low-loss capacitor calibration *2	Calibration reference plane	7-mm low-loss capacitor included with the 16195B
Port extension compensation (fixture selection)	(Input electrical length from calibration reference plane to DUT connection plane *3)	Not used
Open/short compensation *4	DUT connection terminal for dedicated test fixture	Not used (method depends on test fixture to be used)

*1. Also performs DC open/short/load calibration if required.

*2. This calibration is performed only when high-accuracy high-Q measurement (low dissipation factor measurement) is required at about 1 GHz or more.

*3. When you use a dedicated test fixture with registered electrical length, automatic entry is made by simply selecting the model number in the softkey menu.

*4. Also performs DC open/short compensation if required.

1. How to define calibration and compensation kit and how to register electrical length for port extension compensation

Step 1. Check the definition of the calibration kit to be used according to “How to Define Calibration Kit” on page 145 and change it if required.

Step 2. Check the definition of the compensation kit to be used according to “How to Define Compensation Kit” on page 147 and change it if required.

Step 3. When using test fixtures other than 16191A, 16192A, 16193A, 16194A, 16196A, 16196B, or 16196C, register the name and electrical length of the test fixture as described in “Registering the Electrical Length of Unregistered Test Fixtures” on page 149.

2. How to select the measurement point table

To perform calibration or compensation data measurement for only one of the eight measurement point tables, perform the following steps to select the table as the active table.

NOTE

When performing calibration or compensation data measurement for all of the measurement point tables, is not necessary to select the measurement point table.

Step 1. Press the [**Stml Select**] key on the front panel to display the Stml Select softkey menu.

Calibration and Compensation

Calibration and Compensation Procedures Using Dedicated Test Fixture

- Step 2.** Press the **TABLE No. []** key in the softkey menu to display the TABLE No. [] softkey menu.
- Step 3.** In the softkey menu, press the key (**TABLE 1** to **TABLE 8**) corresponding to the measurement point table for which calibration and compensation data measurement should be performed.

3. How to display the Calibration Dialog box

- Step 1.** Press the **[Cal/Compen]** key on the front panel to display the Cal/Compen softkey menu.
- Step 2.** Press the **CAL DIALOG** key in the softkey menu to display the Calibration Dialog box (Figure 6-4).

Figure 6-4

Calibration Dialog box

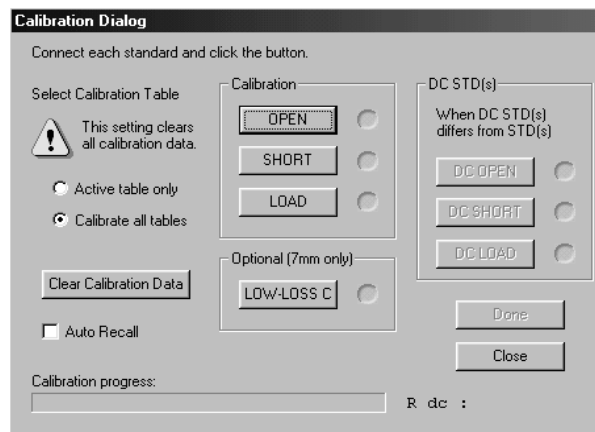

NOTE

The following points require attention when performing calibration data measurement.

- When you start the calibration data measurement, a bar appears in the Calibration progress indicator box of the dialog box to show how the measurement is progressing. Upon completion of data measurement, a blue mark (●) appears to the right of the executed calibration button.
- When the OPEN, SHORT, or LOAD button or the DC OPEN, DC SHORT, or DC LOAD button is pressed, the value of the DC resistance (R_{dc}) measured as the calibration data is shown in the lower-right area of the dialog box upon completion of the respective measurement (Figure 6-5). Checking this indication at the time of calibration data measurement makes it possible to determine that the standard is properly attached.
- Maximum displaying value of the DC resistance is 100 kΩ.

Figure 6-5 **Displaying measured DC resistance value (at calibration data measurement)**

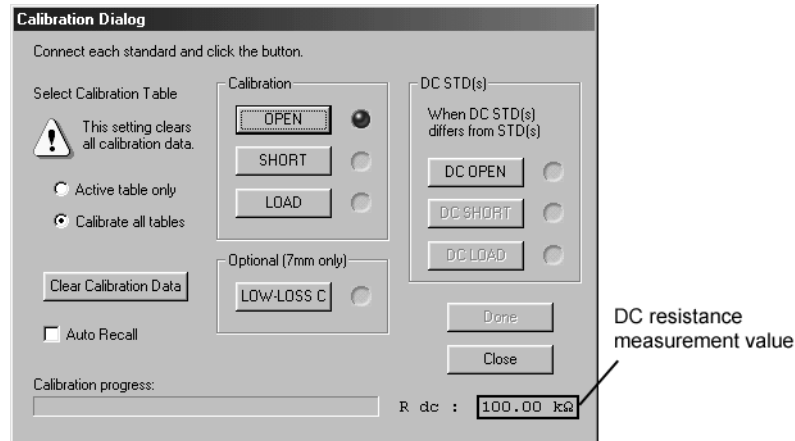

- To erase all calibration data after measurement is finished, press the Clear Calibration Data button.
- To close the dialog box during calibration, press the **Close** button.
- After turning all of the connector nuts on the standard to secure them to the 7-mm terminals, it is not necessary to turn the connector nut of the 7-mm terminal of the test head to secure it.

4. How to select the table range for executing the calibration

Select the table range for executing the calibration by making the appropriate setting in the **Select Calibration Table** area of the Calibration Dialog box window.

If you select **Active table only**, calibration will be executed only for the measurement point table (active table) selected according to “How to select the measurement point table” on page 115.

When you select **Calibrate All Tables**, calibration will be executed for all measurement point tables.

5. How to measure open calibration data

- Step 1.** With the test head mounted on the test fixture stand, turn the outer connector nut of the 7-mm connector clockwise as viewed from the top (Figure 6-6) until the connector sleeve is fully extended.

Figure 6-6 How to extend the 7-mm connector sleeve

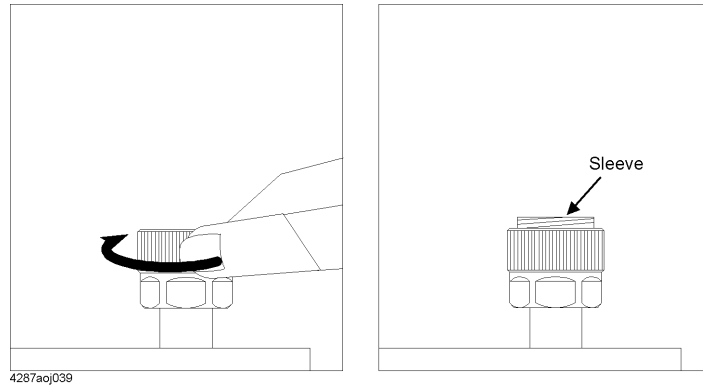

Step 2. Firmly connect the open standard ($0\ S$) to the 7-mm terminal on the test head by turning it clockwise as viewed from the top (Figure 6-7).

Figure 6-7 How to connect open standard

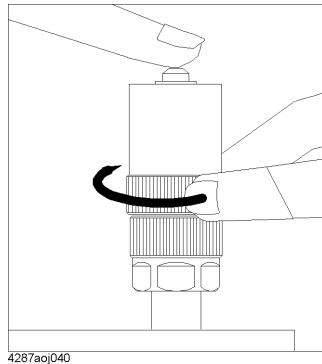

Step 3. Click the **OPEN** button in the calibration window and measure the open calibration data.

Step 4. Turn the open standard counterclockwise as viewed from the top and remove it from the 7-mm terminal.

6. How to measure short calibration data

Step 1. Firmly connect the short standard ($0\ \Omega$) to the 7-mm terminal on the test head by turning it clockwise as viewed from the top (Figure 6-8).

Figure 6-8

How to connect short standard

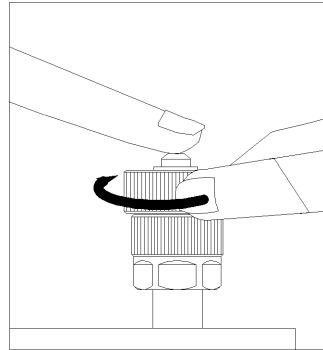

Step 2. Click the **SHORT** button in the calibration window and measure the short calibration data.

Step 3. Turn the short standard counterclockwise viewed from the top and remove the short standard from the 7-mm terminal.

7. How to measure load calibration data

Step 1. Turn the connector nut outside the load standard ($50\ \Omega$) counterclockwise viewed from the side where the connector is mounted and completely retract the internal connector sleeve (Figure 6-9).

Figure 6-9

How to retract load standard connector sleeve

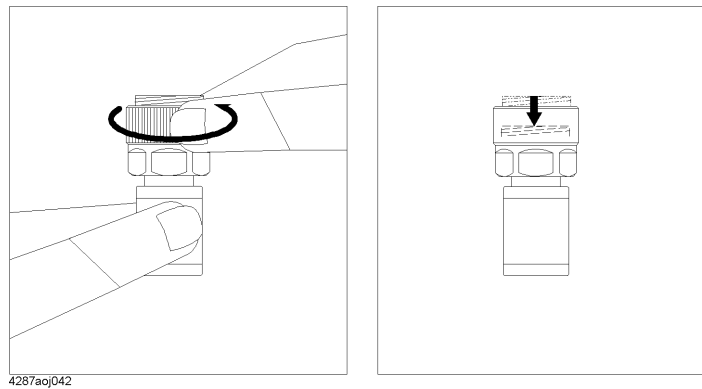

Step 2. Firmly connect the load standard to the 7-mm terminal on the test head by turning the connector nut clockwise as viewed from the top (Figure 6-10).

Figure 6-10

How to connect load standard

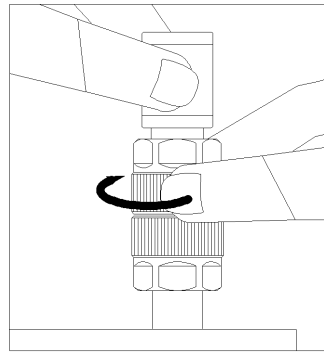

Step 3. Click the **LOAD** button in the calibration window and measure the load calibration data.

Step 4. Turn the connector nut outside the load standard counterclockwise as viewed from the top and remove the load standard from the 7-mm terminal.

8. How to measure DC open/short/load calibration data

To use the dedicated open/short/load standard to measure DC resistance (R_{dc}), execute additional DC open/short/load calibration as follows:

Step 1. Connect the DC open standard to the 7-mm connector on the test head.

Step 2. Click the **DC OPEN** button in the calibration window and measure the open calibration data.

Step 3. Remove the DC open standard and connect the DC short standard in its place.

Step 4. Click the **DC SHORT** button in the calibration window and measure the short calibration data.

Step 5. Remove the DC short standard and connect the DC load standard in its place.

Step 6. Click the **DC LOAD** button in the calibration window and measure the DC load calibration data.

Step 7. Remove the DC load standard from the 7-mm terminal.

9. How to measure low-loss capacitor calibration data

Step 1. Firmly connect the low-loss capacitor to the 7-mm terminal on the test head by turning the connector nut clockwise as viewed from the top (Figure 6-11).

CAUTION

Do not turn the knob of the LOW-LOSS CAPACITOR. Lightly hold the knob to prevent the inner coaxial electrodes from moving when turning the outer connector nut of the LOW-LOSS CAPACITOR.

Figure 6-11

How to connect low-loss capacitor

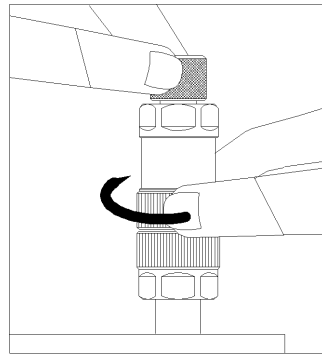

- Step 2.** Click the **LOW-LOSS C** button in the calibration window and measure the low-loss capacitor data.
- Step 3.** Turn the connector nut outside the low-loss capacitor counterclockwise as viewed from the top and remove it from the 7-mm terminal.

10. Specifying creation of automatic setting file for when power is turned ON

The setting conditions of the 4287A, including calibration data and compensation data, can be automatically stored for reuse in a file named “autorec.sta” in the internal nonvolatile memory. To use this function, click the Auto Recall check box upon completion of calibration so that the check mark (√) appears.

NOTE

When the 4287A is turned ON, it searches the internal nonvolatile memory for a file called “autorec.sta,” and if it is found, the setting conditions (including calibration and compensation data) stored in the file are automatically recalled.

As described in “20. Specifying creation of automatic setting file for when power is turned ON” on page 130, it is also possible to automatically store the setting conditions, including the compensation data, in a file named “autorec.sta” upon completion of compensation. When this is done, the calibration data executed immediately before compensation are simultaneously saved. Accordingly, if both calibration and compensation are to be executed, it is not necessary to click the **Auto Recall** check box at the time of calibration.

11. How to exit calibration

To exit calibration, click the **Done** button in the calibration window.

12. How to mount dedicated test fixture

Mount the dedicated test fixture on the 7-mm terminal of the test head. For the mounting procedure, see the *Operation Manual* for the test fixture.

13. How to carry out port extension compensation (fixture selection)

- Step 1.** Press the Select Fixture key in the Cal/Compen softkey menu to display the SELECT FIXTURE softkey menu.

Calibration and Compensation
Calibration and Compensation Procedures Using Dedicated Test Fixture

Step 2. In the softkey menu, press the key corresponding to the model number (or a fixture name registered by the user) of the test fixture to be used.

Softkey	Test Fixture (Electrical Length)
16191A [14.0 mm]	Agilent 16191A (14.0 mm)
16192A [11.0 mm]	Agilent 16192A (11.0 mm)
16193A [14.0 mm]	Agilent 16193A (14.0 mm)
16194A [50.0 mm]	Agilent 16194A (50.0 mm)
16196A [26.2 mm]	Agilent 16196A (26.2 mm)
16196B [26.9 mm]	Agilent 16196B (26.9 mm)
16196C [27.1 mm]	Agilent 16196C (27.1 mm)
USER *1	(Fixture registered by user)

*1. Or fixture name registered according to “Registering the Electrical Length of Unregistered Test Fixtures” on page 149.

14. How to display the compensation dialog box

Press the COMPEN DIALOG key in the softkey menu to display the Compensation Dialog box (Figure 6-12).

Figure 6-12

Compensation Dialog box

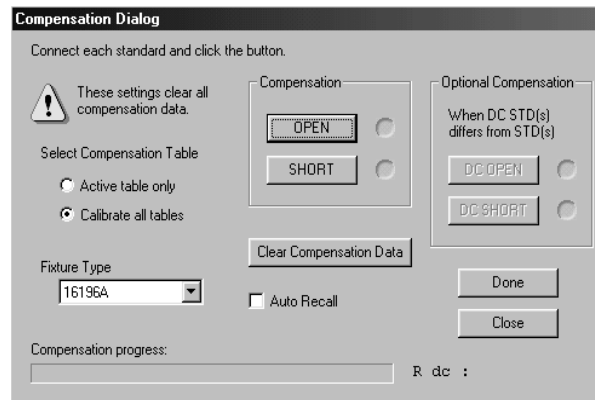

NOTE

The following points require attention when performing compensation data measurement.

- When you start the compensation data measurement, a bar appears in the Compensation progress indicator box of the dialog box to show how the measurement is progressing. Upon completion of data measurement, a blue mark (●) appears to the right of the executed compensation button.
- When the **OPEN**, **SHORT**, or **LOAD** button or the **DC OPEN**, **DC SHORT**, or **DC LOAD** button is pressed, the value of the DC resistance (R_{dc}) measured as the compensation data is shown in the lower-right area of the dialog box upon completion of the respective measurement. Checking this indication at the time of compensation data measurement makes it possible to determine that the standard is properly attached.

- To erase all compensation data after measurement is finished, press the **Clear Compensation Data** button.
- To close the dialog box during compensation, press the **Close** button.

15. How to select the table range for executing the compensation

Select the table range for executing the compensation by making the appropriate setting in the **Select Compensation Table** area of the Compensation Dialog box window.

If you select **Active table only**, compensation will only be executed for the measurement point table (active table) selected in “2. How to select the measurement point table” on page 121.

If you select **Calibrate all tables**, compensation will be executed for all measurement point tables.

NOTE

If you select **Calibrate all tables** (to execute compensation for all measurement point tables) in the Compensation Dialog box, calibration data measurement will be performed in accordance with the conditions set in “4. How to select the table range for executing the calibration” on page 123.

16. How to confirm port extension compensation (fixture selection)

Check that the test fixture selected in “13. How to carry out port extension compensation (fixture selection)” on page 127 is indicated in the Fixture Type box of the Compensation Dialog box.

NOTE

Instead of using the procedure of “13. How to carry out port extension compensation (fixture selection)” on page 127, it is also possible to perform (or change) the setting of the port extension compensation (fixture selection) in this Compensation Dialog box.

To perform (or change) the port extension compensation (fixture selection) setting, move the cursor to the **Fixture Type** box and select the model number (or a fixture name registered by the user) of the test fixture to be used. When using the mouse, click the down-arrow ▼ to the right of the **Fixture Type** box to open a drop-down list box. Select the model number (or a fixture name registered by the user) of the test fixture to be used from the list by clicking the desired option.

Be sure to set the port extension compensation (fixture selection) before executing measurement of open/short compensation data. If the fixture selection is changed after measurement of open/short compensation data, the open/short compensation data are automatically erased.

17. How to measure open compensation data

Follow these steps to measure the open compensation data.

- Step 1.** Set the DUT connection terminal of the dedicated test fixture to the open state. For how to set it to the open state, see the Operation Manual of the test fixture to be used.
- Step 2.** Click the **OPEN** button in the compensation window and measure the open compensation data.

18. How to measure short compensation data

Follow these steps to measure the short compensation data.

- Step 1.** Set the DUT connection terminal of the dedicated test fixture to the short state. For how to set it to the short state, see the Operation Manual of the test fixture to be used.
- Step 2.** Click the **SHORT** button in the compensation window and measure the short compensation data.

19. How to measure DC open/short compensation data

Follow these steps to perform open/short compensation specifically for DC resistance (R_{dc}) measurement:

- Step 1.** Set the DUT connection terminal of the dedicated test fixture to the open state.
- Step 2.** Click the **DC OPEN** button in the compensation window and measure the open compensation data.
- Step 3.** Set the DUT connection terminal of the test fixture to the short state.
- Step 4.** Click the **DC SHORT** button in the compensation window and measure the short compensation data.

20. Specifying creation of automatic setting file for when power is turned ON

The setting conditions of the 4287A, including calibration data and compensation data, can be automatically stored for reuse in a file named “autorec.sta” in the internal nonvolatile memory. To use this function, click the **Auto Recall** check box upon completion of compensation so that the check mark (√) appears.

NOTE

When the 4287A is turned ON, it searches the internal nonvolatile memory for a file called “autorec.sta,” and if it is found, the setting conditions (including calibration and compensation data) stored in the file are automatically recalled.

21. How to end compensation

Press the **Done** button in the Compensation Dialog box to end compensation and close the dialog box.

2. DUT connection terminal used as calibration reference plane

The following describes the calibration and compensation necessary for using the DUT connection terminal of the dedicated test fixture as a calibration reference plane. As indicated in Table 6-4, only execution of open/short/load calibration is required.

Table 6-4 Calibration compensation to use DUT connection terminal as calibration reference plane

Required calibration	Position to be calibrated	Standard used
Open/short/load calibration *1	DUT connection terminal of the dedicated test fixture (used as calibration reference plane)	Working standard *2 (open/short/load)

*1. Perform DC open/short/load calibration as required.

*2. Use the Agilent 4287A option 004 (working standard set). Open calibration and short calibration can be made in the open state or short state specified by the fixture; it is not necessary to use a special standard that has the same shape as the DUT.

1. How to check and change calibration kit definition

Check the definition of the working standard to be used and change it as required by following the steps in “How to Define Calibration Kit” on page 145.

2. How to select the measurement point table

To perform calibration data measurement for only one of the eight measurement point tables, follow these steps to select the active table.

NOTE When performing calibration data measurement for all of the measurement point tables at once, it is not necessary to select individual measurement point tables.

- Step 1.** Press the **[Stml Select]** key on the front panel to display the Stml Select softkey menu.
- Step 2.** Press the **TABLE No. []** key in the softkey menu to display the TABLE No. [] softkey menu.
- Step 3.** In the softkey menu, press the key (**TABLE 1** to **TABLE 8**) corresponding to the measurement point table for which calibration data measurement should be performed.

3. How to display the Calibration Dialog box

Follow these steps to display the calibration window.

- Step 1.** Press the **[Cal/Compen]** key on the front panel to display the Cal/Compen softkey menu.
- Step 2.** Press the **CAL DIALOG** key in the softkey menu to display the Calibration Dialog box (Figure 6-13).

Figure 6-13

Calibration Dialog box

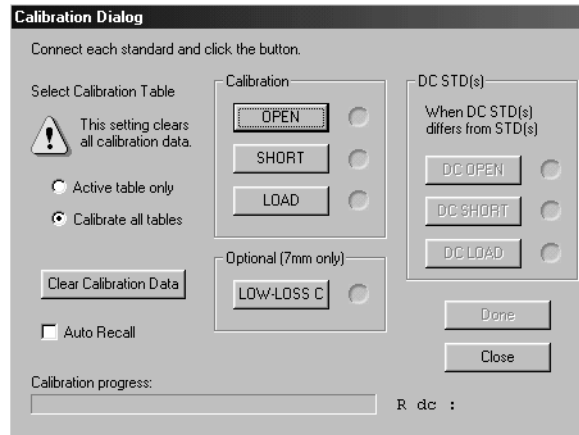

NOTE

The following points require attention when performing calibration data measurement.

- When you start the calibration data measurement, a bar appears in the Calibration progress indicator box of the dialog box to show how the measurement is progressing. Upon completion of data measurement, a blue mark (●) appears to the right of the executed calibration button.

When the **OPEN**, **SHORT**, or **LOAD** button or the **DC OPEN**, **DC SHORT**, or **DC LOAD** button is pressed, the value of the DC resistance (R_{dc}) measured as the calibration data is shown in the lower-right area of the dialog box upon completion of the respective measurement. Checking this indication at the time of calibration data measurement makes it possible to determine that the standard is properly attached.

- To erase all calibration data after measurement is finished, press the **Clear Calibration Data** button.
- To close the dialog box during calibration, press the **Close** button.
- After turning all of the connector nuts on the standard to secure them to the 7-mm terminals, it is not necessary to turn the connector nut of the 7-mm terminal of the test head to secure it.

4. How to select the table range for executing the calibration

Select the table range for executing the calibration by making the appropriate setting in the **Select Calibration Table** area of the Calibration Dialog box window.

If you select **Active table only**, calibration will only be executed for the measurement point table (active table) selected in “2. How to select the measurement point table” on page 131.

If you select **Calibrate all tables**, calibration will be executed for all measurement point tables.

5. How to measure open calibration data

Measure the open calibration data as follows:

- Step 1.** Connect the open standard to the DUT connection terminal of the test fixture.

NOTE If you want to use the open state of the test fixture instead of connecting the open standard, set the open state according to the Operation Manual of the test fixture.

Step 2. Click the **OPEN** button in the calibration window and measure the open calibration data.

6. How to measure short calibration data

Measure the short calibration data as follows:

Step 1. Connect the short standard to the DUT connection terminal of the test fixture.

NOTE If you want to use the short state of the test fixture instead of connecting the short standard, set the short state according to the Operation Manual of the test fixture.

Step 2. Click the **SHORT** button in the calibration window and measure the short calibration data.

7. How to measure load calibration data

Measure the load calibration data as follows:

Step 1. Connect the load standard to the DUT connection terminal of the test fixture.

Step 2. Click the **LOAD** button in the calibration window and measure the load calibration data.

8. How to measure DC open/short/load calibration data

When you want to use the dedicated working standard to measure DC resistance (Rdc), follow these steps to execute additional DC open/short/load calibration.

Step 1. Connect the DC open standard to the DUT connection terminal of the test fixture.

Step 2. Click the **DC OPEN** button in the calibration window and measure the DC open calibration data.

Step 3. Connect the DC short standard to the DUT connection terminal of the test fixture.

Step 4. Click the **DC SHORT** button in the calibration window and measure the DC short calibration data.

Step 5. Connect the load standard to the DUT connection terminal of the test fixture.

Step 6. Click the **DC LOAD** button in the calibration window and measure the DC load calibration data.

9. Specifying creation of automatic setting file for when power is turned ON

The setting conditions of the 4287A, including calibration data and compensation data, can be automatically stored for reuse in a file named “autorec.sta” in the internal nonvolatile memory. To use this function, click the **Auto Recall** check box upon completion of calibration so that the check mark (√) appears.

NOTE When the 4287A is turned ON, it searches the internal nonvolatile memory for a file called “autorec.sta,” and if it is found, the setting conditions (including calibration and compensation data) stored in the file are automatically recalled.

10. How to end calibration

Press the **Done** button in the Calibration Dialog box to end calibration and close the dialog box.

Calibration and Compensation Procedure without Using Dedicated Test Fixture

The following describes the calibration and compensation procedure when the dedicated test fixture is not used. In this case, the test head coaxial terminal is extended, and the DUT is connected to the tip of the terminal. When you want to connect the Agilent 4287A to the handler to perform Automatic sorting, follow the steps below.

1. Test head coaxial terminal used as calibration reference plane

Follow the calibration compensation steps shown in Table 6-5 when the test head coaxial terminal is used as a calibration reference plane.

Table 6-5 Calibration and compensation using test head coaxial terminal as calibration reference plane

Required calibration	Position to be calibrated	Standard used
Open/short/load calibration *1	Test head coaxial terminal *2 (used as calibration reference plane)	Open/short/load calibration kit (e.g. 16195B for 7-mm terminal)
Low-loss capacitor calibration *3	Calibration reference plane	7-mm low-loss capacitor included with the 16195B
Port extension compensation (Fixture selection)	(Input electrical length from calibration reference plane to DUT connection plane)	Not used
Open/short compensation *4	DUT connection terminal	Not used

*1. Perform DC open/short/load calibration as required.

*2. It is not always necessary to use a 7-mm terminal.

*3. This calibration is performed only when high-accuracy high-Q measurement (low dissipation factor measurement) is required at about 1 GHz or more. It should be noted, however, that this can be performed only when the 7-mm terminal is used as a calibration reference plane since the 7-mm low-loss capacitor is used.

*4. Also performs DC open/short compensation if required.

1. How to define calibration and compensation kit and how to register electrical length for port extension compensation.

- Step 1.** Check the definition of the calibration kit to be used according to “How to Define Calibration Kit” on page 145 and change it if required.
- Step 2.** Check the definition of the compensation kit to be used according to “How to Define Compensation Kit” on page 147 and change it if required.
- Step 3.** Register the electrical length data from the calibration reference plane to the DUT plane according to “Registering the Electrical Length of Unregistered Test Fixtures” on page 149.

2. How to select the measurement point table

To perform calibration data measurement for only one of the eight measurement point

tables, follow these steps to select the active table.

NOTE

When performing calibration data measurement for all of the measurement point tables at once, it is not necessary to select individual measurement point tables.

- Step 1.** Press the [**Stml Select**] key on the front panel to display the Stml Select softkey menu.
- Step 2.** Press the **TABLE No. []** key in the softkey menu to display the TABLE No. [] softkey menu.
- Step 3.** In the softkey menu, press the key (**TABLE 1 to TABLE 8**) corresponding to the measurement point table for which calibration and compensation data measurement should be performed.

3. How to display the Calibration Dialog box

- Step 1.** Press the [**Cal/Compen**] key on the front panel to display the Cal/Compen softkey menu.
- Step 2.** Press the **CAL DIALOG** key in the softkey menu to display the Calibration Dialog box (Figure 6-14).

Figure 6-14

Calibration Dialog box

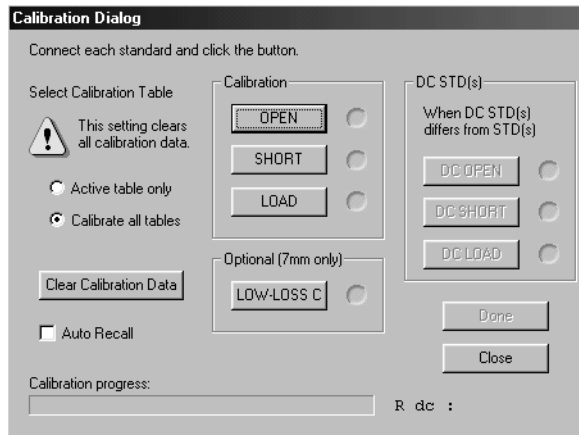

NOTE

The following points require attention when performing calibration data measurement.

- When you start the calibration data measurement, a bar appears in the Calibration progress indicator box of the dialog box to show how the measurement is progressing. Upon completion of data measurement, a blue mark (●) appears to the right of the executed calibration button.
- When the **OPEN**, **SHORT**, or **LOAD** button or the **DC OPEN**, **DC SHORT**, or **DC LOAD** button is pressed, the value of the DC resistance (R_{dc}) measured as the calibration data is shown in the lower-right area of the dialog box upon completion of the respective measurement. Checking this indication at the time of calibration data measurement makes it possible to determine that the standard is properly attached.
- To erase all calibration data after measurement is finished, press the **Clear Calibration Data** button.
- To close the dialog box during calibration, press the **Close** button.

4. How to select the table range for executing the calibration

Select the table range for executing the calibration by making the appropriate setting in the **Select Calibration Table** area of the Calibration Dialog box window.

If you select **Active table only**, compensation will only be executed for the measurement point table (active table) selected in “2. How to select the measurement point table” on page 135.

If you select **Calibrate all tables**, compensation will be executed for all measurement point tables.

5. How to measure open calibration data

Measure the open calibration data as follows:

- Step 1.** Connect the open standard (0 S) to the coaxial terminal on the tip of the test head as a calibration reference plane.
- Step 2.** Click the **OPEN** button in the calibration window and measure the open calibration data.
- Step 3.** Remove the open standard from the test head coaxial terminal.

6. How to measure short calibration data

Measure the short calibration data as follows:

- Step 1.** Connect the short standard (0 Ω) to the coaxial terminal on the tip of the test head as a calibration reference plane.
- Step 2.** Click the **SHORT** button in the calibration window and measure the short calibration data.
- Step 3.** Remove the short standard from the test head coaxial terminal.

7. How to measure load calibration data

Measure the load calibration data as follows:

- Step 1.** Connect the load standard (50 Ω) to the coaxial terminal on the tip of the test head as a calibration reference plane.
- Step 2.** Click the **LOAD** button in the calibration window and measure the load calibration data.
- Step 3.** Remove the load standard from the test head coaxial terminal.

8. How to measure DC open/short/load calibration data

When you want to use the dedicated open/short/load standard to measure DC resistance (Rdc), follow these steps to execute additional DC open/short/load calibration.

- Step 1.** Connect the DC open standard to the coaxial terminal on the tip of the test head as a calibration reference plane.
- Step 2.** Click the **DC OPEN** button in the calibration window and measure the DC open calibration data.
- Step 3.** Remove the DC open standard and connect the DC short standard.
- Step 4.** Click the **DC SHORT** button in the calibration window and measure the DC short calibration data.

- Step 5.** Remove the DC short standard and connect the DC load standard.
- Step 6.** Click the **DC LOAD** button in the calibration window and measure the DC load calibration data.
- Step 7.** Remove the DC load standard.

9. How to measure low-loss capacitor calibration data

When a 7-mm terminal is used as a coaxial terminal of the test head and serves as a calibration reference plane, measure the low-loss capacitor calibration data as follows:

- Step 1.** Connect the low-loss capacitor to the 7-mm terminal as a calibration reference plane.
- Step 2.** Click the **LOW-LOSS C** button in the calibration window and measure the low-loss capacitor data.
- Step 3.** Remove the low-loss capacitor from the 7-mm terminal.

10. Specifying creation of automatic setting file for when power is turned ON

The setting conditions of the 4287A, including calibration data and compensation data, can be automatically stored for reuse in a file named “autorec.sta” in the internal nonvolatile memory. To use this function, click the **Auto Recall** check box upon completion of calibration so that the check mark (√) appears.

NOTE

When the 4287A is turned ON, it searches the internal nonvolatile memory for a file called “autorec.sta,” and if it is found, the setting conditions (including calibration and compensation data) stored in the file are automatically recalled.

As described in “20. Specifying creation of automatic setting file for when power is turned ON” on page 140, it is also possible to automatically store the setting conditions, including the compensation data, in a file named “autorec.sta” upon completion of compensation. When this is done, the calibration data executed immediately before compensation are simultaneously saved. Accordingly, if both calibration and compensation are to be executed, it is not necessary to click the **Auto Recall** check box at the time of calibration.

11. How to end calibration

Press the **Done** button in the Calibration Dialog box to end calibration and close the dialog box.

12. How to connect cable and test fixture

Connect the cable and test fixture required to connect the DUT to the tip of the calibration reference plane.

13. How to carry out port extension compensation (fixture selection)

- Step 1.** Press the **Select Fixture** key in the Cal/Compen softkey menu to display the SELECT FIXTURE softkey menu.
- Step 2.** Press the key corresponding to the fixture name (this is **USER []** if no name is entered) registered in Step 3 of “1. How to define calibration and compensation kit and how to register electrical length for port extension compensation.” on page 135.

14. How to display the compensation dialog box

Press the **COMPEN DIALOG** key in the Cal/Compen softkey menu to display the Compensation Dialog box.

Figure 6-15

Compensation Dialog box

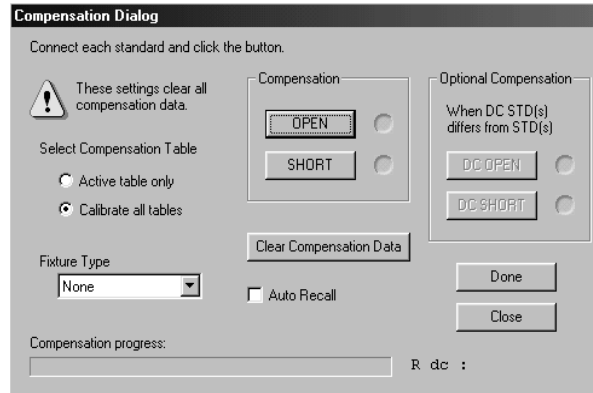

NOTE

The following points require attention when performing compensation data measurement.

- When you start the compensation data measurement, a bar appears in the Compensation progress indicator box of the dialog box to show how the measurement is progressing. Upon completion of data measurement, a blue mark (●) appears to the right of the executed compensation button.
- When the **OPEN**, **SHORT**, or **LOAD** button or the **DC OPEN**, **DC SHORT**, or **DC LOAD** button is pressed, the value of the DC resistance (R_{dc}) measured as the compensation data is shown in the lower-right area of the dialog box upon completion of the respective measurement. Checking this indication at the time of compensation data measurement makes it possible to determine that the standard is properly attached.
- To erase all compensation data after measurement is finished, press the **Clear Compensation Data** button.
- To close the dialog box during compensation, press the **Close** button.

15. How to select the table range for executing the compensation

Select the table range for executing the compensation by making the appropriate setting in the **Select Compensation Table** area of the Compensation Dialog box window.

If you select **Active table only**, compensation will only be executed for the measurement point table (active table) selected in “2. How to select the measurement point table” on page 135.

If you select **Calibrate all tables**, compensation will be executed for all measurement point tables.

NOTE

If you select **Calibrate all tables** (to execute compensation for all measurement point tables) in the Compensation Dialog box, calibration data measurement will be performed in accordance with the conditions set in “4. How to select the table range for executing the calibration” on page 137.

16. How to confirm port extension compensation (fixture selection)

Check that the test fixture selected in “13. How to carry out port extension compensation (fixture selection)” on page 138 is indicated in the Fixture Type box of the Compensation Dialog box.

NOTE

Be sure to set the port extension compensation (fixture selection) before executing measurement of open/short compensation data. If the fixture selection is changed after measurement of open/short compensation data, the open/short compensation data are automatically erased.

17. How to measure open compensation data

Measure the open compensation data as follows:

- Step 1.** Set the DUT connection terminal to the open state.
- Step 2.** Click the **OPEN** button in the compensation window and measure the open compensation data.

18. How to measure short compensation data

Measure the short compensation data as follows:

- Step 1.** Set the DUT connection terminal to the short state.
- Step 2.** Click the **SHORT** button in the compensation window and measure the short compensation data.

19. How to measure DC open/short compensation data

Follow these steps to perform open/short compensation specifically for DC resistance (R_{dc}) measurement.

- Step 1.** Set the DUT connection terminal to the open state.
- Step 2.** Click the **DC OPEN** button in the compensation window and measure the DC open compensation data.
- Step 3.** Set the DUT connection terminal to the short state.
- Step 4.** Click the **DC SHORT** button in the compensation window and measure the DC short compensation data.

20. Specifying creation of automatic setting file for when power is turned ON

The setting conditions of the 4287A, including calibration data and compensation data, can be automatically stored for reuse in a file named “autorec.sta” in the internal nonvolatile memory. To use this function, click the **Auto Recall** check box upon completion of compensation so that the check mark (√) appears.

NOTE

When the 4287A is turned ON, it searches the internal nonvolatile memory for a file called “autorec.sta,” and if it is found, the setting conditions (including calibration and compensation data) stored in the file are automatically recalled.

21. How to end compensation

Press the **Done** button in the Compensation Dialog box to end compensation and close the dialog box.

2. DUT connection terminal used as calibration reference plane

When you want to use the DUT connection terminal as a calibration reference plane, connect the working standard to the DUT connection terminal to perform open/short/load calibration (Table 6-6). No other calibration compensation is necessary.

Table 6-6 Calibration compensation to use DUT connection terminal as calibration reference plane

Required calibration	Position to be calibrated	Standard used
Open/short/load calibration *1	DUT terminal (as calibration reference plane)	Working standard *2 (open/short/load)

*1. Perform DC open/short/load calibration as required.

*2. Use the Agilent 4287A option 004 (working standard set). Open calibration and short calibration can be made by opening or shorting between DUTs; it is not necessary to use a special standard that has the same shape as the DUT.

1. How to check and change calibration kit definition

Check the definition of the working standard to be used and change it as required as described in “How to Define Calibration Kit” on page 145.

2. How to select the measurement point table

To perform calibration data measurement for only one of the eight measurement point tables, follow these steps to select the active table.

NOTE

When performing calibration data measurement for all of the measurement point tables at once, it is not necessary to select individual measurement point tables.

Step 1. Press the [**Stml Select**] key on the front panel to display the Stml Select softkey menu.

Step 2. Press the **TABLE No. []** key in the softkey menu to display the TABLE No. [] softkey menu.

Step 3. In the softkey menu, press the key (**TABLE 1** to **TABLE 8**) corresponding to the measurement point table for which calibration data measurement should be performed.

3. How to display the Calibration Dialog box

Perform the following steps to display the Calibration Dialog box.

Step 1. Press the [**Cal/Compen**] key on the front panel to display the Cal/Compen softkey menu.

Step 2. Press the **CAL DIALOG** key in the softkey menu to display the Calibration Dialog box (Figure 6-16).

Figure 6-16

Calibration Dialog box

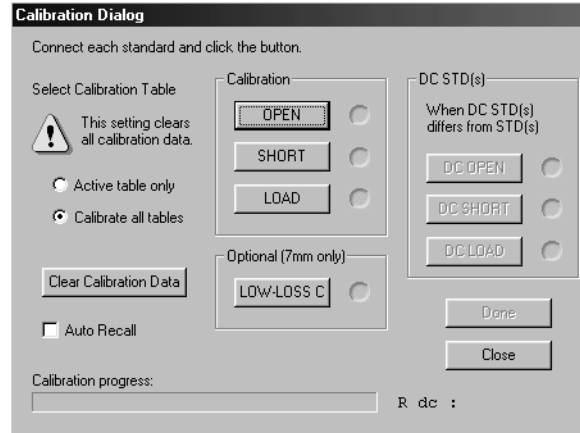

NOTE

The following points require attention when performing calibration data measurement.

- When you start the calibration data measurement, a bar appears in the Calibration progress indicator box of the dialog box to show how the measurement is progressing. Upon completion of data measurement, a blue mark (●) appears to the right of the executed calibration button.
- When the **OPEN**, **SHORT**, or **LOAD** button or the **DC OPEN**, **DC SHORT**, or **DC LOAD** button is pressed, the value of the DC resistance (R_{dc}) measured as the calibration data is shown in the lower-right area of the dialog box upon completion of the respective measurement. Checking this indication at the time of calibration data measurement makes it possible to determine that the standard is properly attached.
- To erase all calibration data after measurement is finished, press the **Clear Calibration Data** button.
- To close the dialog box during calibration, press the **Close** button.
- After turning all of the connector nuts on the standard to secure them to the 7-mm terminals, it is not necessary to turn the connector nut of the 7-mm terminal of the test head to secure it.

4. How to select the table range for executing the calibration

Select the table range for executing the calibration by making the appropriate setting in the **Select Calibration Table** area of the Calibration Dialog box window.

If you select **Active table only**, calibration will only be executed for the measurement point table (active table) selected in “2. How to select the measurement point table” on page 142.

If you select **Calibrate all tables**, calibration will be executed for all measurement point tables.

5. How to measure open calibration data

Measure the open calibration data as follows:

- Step 1.** Connect the open standard to the DUT connection terminal.

Calibration and Compensation

Calibration and Compensation Procedure without Using Dedicated Test Fixture

Step 2. Click the **OPEN** button in the calibration window and measure the open calibration data.

6. How to measure short calibration data

Measure the short calibration data as follows:

Step 1. Connect the short standard to the DUT connection terminal.

Step 2. Click the **SHORT** button in the calibration window and measure the short calibration data.

7. How to measure load calibration data

Measure the load calibration data as follows:

Step 1. Connect the load standard to the DUT connection terminal.

Step 2. Click the **LOAD** button in the calibration window and measure the load calibration data.

8. How to measure DC open/short/load calibration data

When you want to use the dedicated open/short/load standard to measure DC resistance (Rdc), follow these steps to execute additional DC open/short/load calibration.

Step 1. Connect the DC open standard to the DUT connection terminal.

Step 2. Click the **DC OPEN** button in the calibration window and measure the DC open calibration data.

Step 3. Connect the short standard to the DUT connection terminal.

Step 4. Click the **DC SHORT** button in the calibration window and measure the DC short calibration data.

Step 5. Connect the load standard to the DUT connection terminal.

Step 6. Click the **DC LOAD** button in the calibration window and measure the load calibration data.

9. Specifying creation of automatic setting file for when power is turned ON

The setting conditions of the 4287A, including calibration data and compensation data, can be automatically stored for reuse in a file named “autorec.sta” in the internal nonvolatile memory. To use this function, click the **Auto Recall** check box upon completion of compensation so that the check mark (√) appears.

NOTE

When the 4287A is turned ON, it searches the internal nonvolatile memory for a file called “autorec.sta,” and if it is found, the setting conditions (including calibration and compensation data) stored in the file are automatically recalled.

10. How to end calibration

Press the **Done** button in the Calibration Dialog box to end calibration and close the dialog box.

How to Define Calibration Kit

Before starting calibration, the characteristic values of the open/short/load standards used for calibration must be set in advance.

For the Agilent 4287A, define the calibration kit by using the circuit model shown in Figure 6-17.

Figure 6-17

Calibration kit circuit model

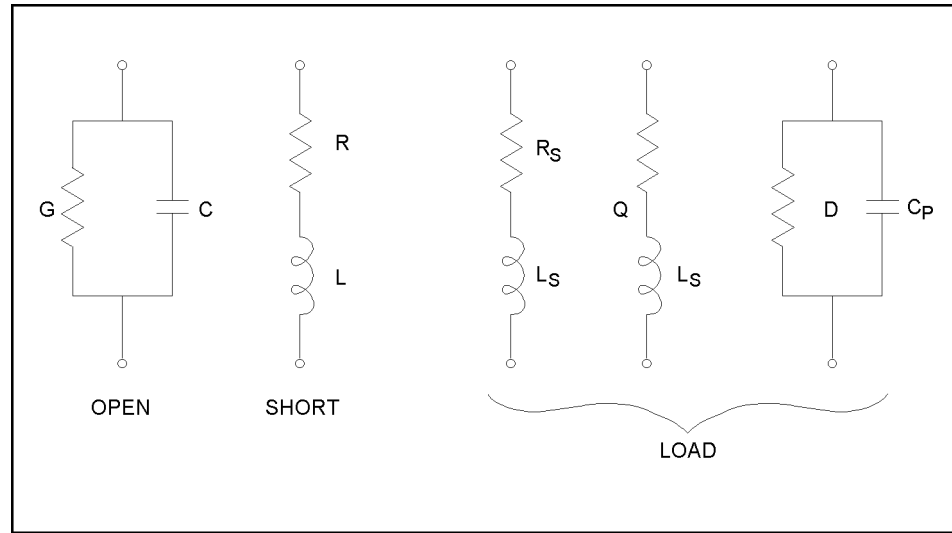

4287aoj037

Calibration kit definition procedure

Follow these steps to define the calibration kit.

- Step 1.** Press the **[Setup View]** key until the calibration kit setup display (Figure 6-18) appears.

Figure 6-18

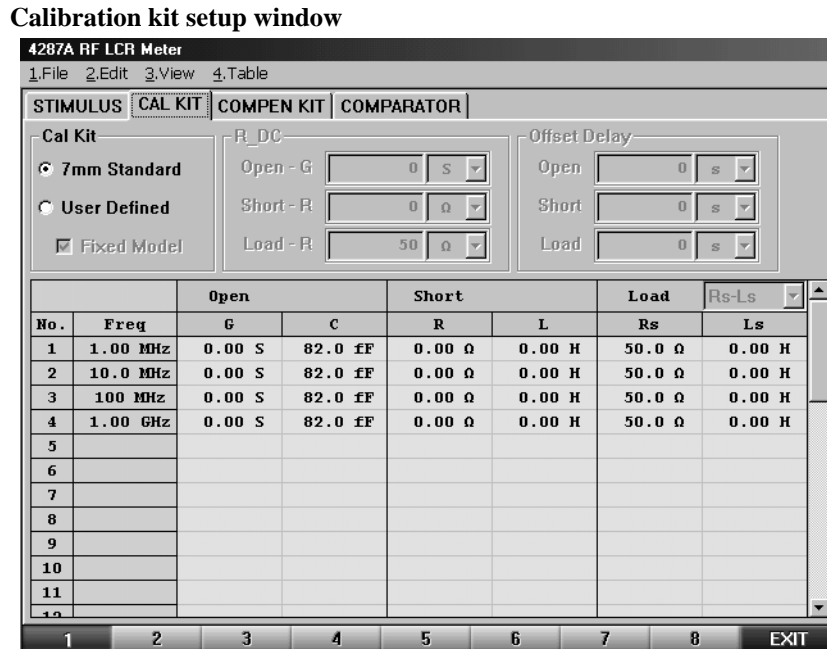

Step 2. Specify the table number to define a calibration kit by following the description in “How to specify table number for setup” on page 104.

Step 3. Select the type of calibration kit (**7-mm Standard** or **User Defined**) from the **Cal Kit** selection area in the calibration kit setup display.

If you have selected “**7-mm Standard**,” the initial value of the 7-mm calibration kit will be used as the defined calibration kit. No further setting is required.

NOTE

When you want to use the Agilent 16195B 7-mm calibration kit, select “**7-mm Standard**.”

If you have selected “**User Defined**,” continue with the following steps:

Step 4. If you want to use the same definition for all measurement points in the measurement point table, click the **Fixed Model** button to attach a check mark (✓).

If you have selected “**Fixed Model**,” set the calibration kit definition for measurement point number 1. For other measurement points, the same definition as that of measurement point number 1 is automatically entered.

Step 5. Select the circuit model to define load from **Rs-Ls**, **Ls-Q** and **Cp-D**.

Step 6. Enter open/short/load definitions for each measurement point.

Step 7. Enter the DC open/short/load definitions.

Step 8. When you want to use a calibration kit other than the 7-mm calibration kit, you may have to set the offset delay. If so, enter each value for offset delay open/short/load.

NOTE

The offset delay value is described in the *Operation Manual* of the calibration kit. Please refer to this manual.

How to Define Compensation Kit

Before starting compensation, characteristic values of the open/short standards used for compensation must be set in advance.

For the Agilent 4287A, define the compensation kit by using the circuit model shown in Figure 6-19.

Figure 6-19

Compensation kit circuit model

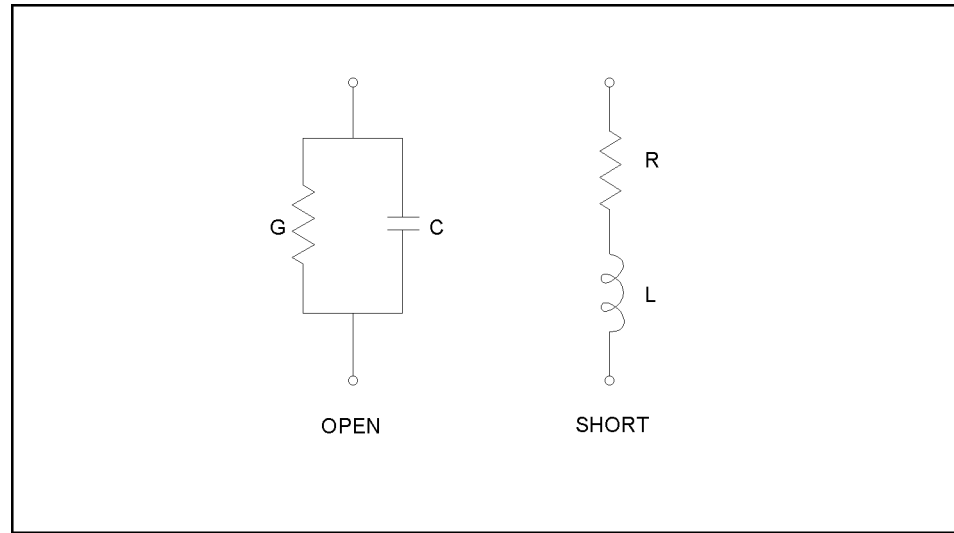

4287aoj038

Compensation kit definition procedure

Follow these steps to define the compensation kit.

- Step 1.** Press the **[Setup View]** key until the compensation kit setup window (Figure 6-20) appears.

Figure 6-20

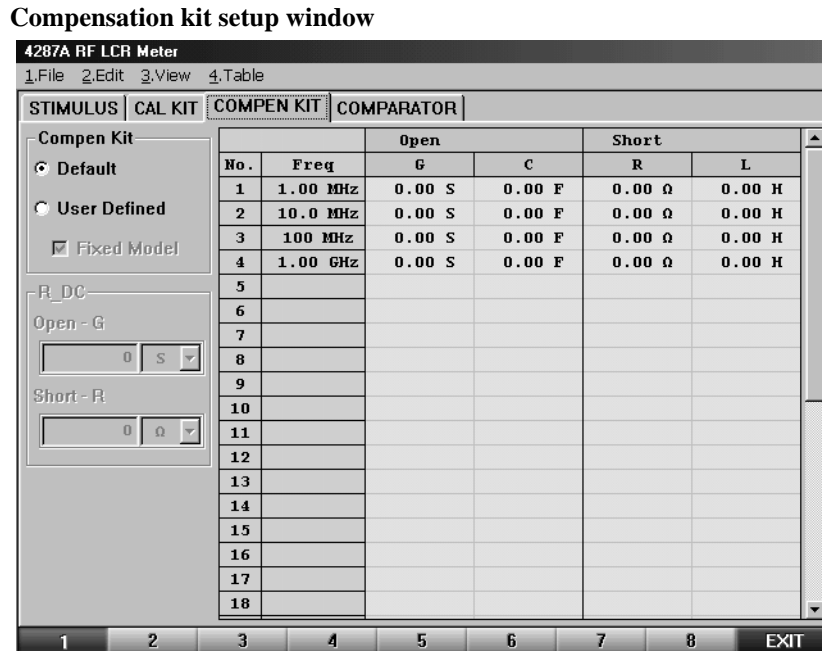

Step 2. Specify the table number to define a compensation kit by following the description in “How to specify table number for setup” on page 104.

Step 3. Select the type of compensation kit (**Default** or **User Defined**) from the **Compen Kit** selection area in the compensation kit setup window.

If you have selected “**Default**,” the initial value of the predetermined compensation kit will be used as the defined compensation kit. No further setting is required.

If you have selected “**User Defined**,” continue with the following steps:

Step 4. If you want to use the same definition for all measurement points in the measurement point table, click the **Fixed Model** button to attach a check mark (√).

If you have selected “**Fixed Model**,” set the compensation kit definition for measurement point number 1. For other measurement points, the same definition as that of measurement point number 1 is automatically entered.

Step 5. Enter open/short definitions for each measurement point.

Step 6. Enter the DC open/short definitions.

Registering the Electrical Length of Unregistered Test Fixtures

For the 4287A, the electrical lengths (from 7-mm terminal to DUT connection plane) of the test fixtures 16191A, 16192A, 16193A, 16194A, 16196A, 16196B, and 16196C are registered in advance. When you use the tip of the 7-mm terminal of the test head as a calibration reference plane and connect any of these test fixtures to the tip, you can execute port extension compensation by selecting the test fixture model number.

When you want to connect an unregistered test fixture of our manufacture or your own test fixture and cables to the tip of the calibration reference plane, it is necessary to perform the following steps to register the name and electrical length of the device before starting calibration and compensation.

NOTE

For how to perform the instruction “press the key (softkey) in the softkey menu” mentioned in the procedure, see “13. Softkeys” on page 87.

Step 1. Press the **[Cal/Compen]** key on the front panel to display the Cal/Compen softkey menu.

Step 2. Press the **SETUP USER FIXTURE** key in the softkey menu to display the SETUP USER FIXTURE softkey menu.

Press the **ELEC. LENGTH []** key in the softkey menu to display the Electrical Length dialog box.

Figure 6-21

Electrical Length dialog box



4287aoj104

Step 3. Enter the electrical length in the input box.

Step 4. Press the **LABEL KIT []** key in the softkey menu to display the User Fixture Label dialog box.

Figure 6-22

User Fixture Label dialog box



Step 5. Enter the label (name) of the newly registered test fixture in the label space at the top of the dialog box.

Preventing Mistakes During Execution of Calibration and Compensation

Setting limit values for the DC resistance (Rdc) measurement value when calibration and compensation are executed makes it possible to detect an improperly attached standard during calibration or any abnormality with the measurement terminals during compensation.

1. Setting the limit for DC resistance (Rdc)

- Step 1.** Press the **[Cal/Compen]** key on the front panel to display the Cal/Compen softkey menu.
- Step 2.** Press the **SETUP CAL WIZARD** key in the softkey menu to display the Calibration/Compensation Wizard Setting dialog box (Figure 6-23).

Figure 6-23

Calibration/Compensation Wizard Setting dialog box

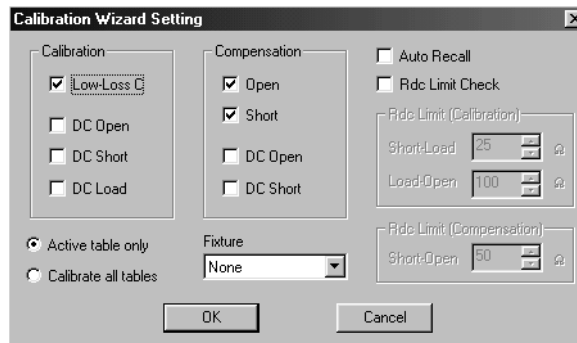

- Step 3.** The following settings should be made in the Calibration/Compensation Wizard Setting dialog box:
 - In the **Calibration** area, select the calibration to be performed in addition to Open/Short/Load calibration.
 - In the **Compensation** area, select the compensation to be executed.
 - For the measurement point table range for which calibration and compensation should be performed, select either **Active table only** or **Calibrate all tables**.
 - Select the test fixture to be used from the **Fixture** area.
 - To automatically store the setting conditions of the 4287A and the calibration and compensation data in the “autorec.sta” file upon completion of the calibration/compensation, click the **Auto Recall** check box so that the check mark (√) appears.
- Step 4.** Click the **Rdc Limit Check** check box in the Calibration/Compensation Wizard Setting dialog box so that the check mark (√) appears, thus turning on the DC resistance (Rdc) limit check when calibration and compensation is performed (Figure 6-24).

Figure 6-24

DC resistance (Rdc) limit check turned ON

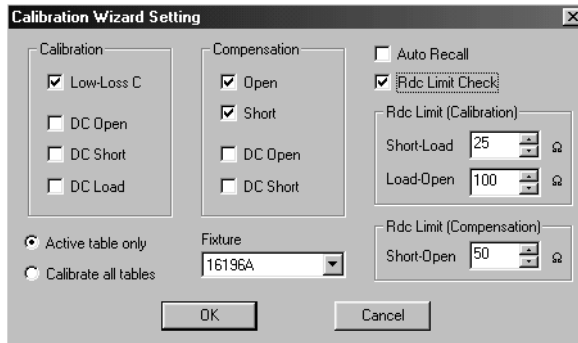

- Step 5.** In the **Short-Load** box in the **Rdc Limit (Calibration)** area of the Calibration/Compensation Wizard Setting dialog box, enter the limit values for DC resistance measurement for short calibration and load calibration.
- Step 6.** In the **Load-Open** box in the **Rdc Limit (Calibration)** area of the Calibration/Compensation Wizard Setting dialog box, enter the limit values for DC resistance measurement for load calibration and open calibration.
- Step 7.** In the **Short-Open** box in the **Rdc Limit (Compensation)** area of the Calibration/Compensation Wizard Setting dialog box, enter the limit values for DC resistance measurement for short compensation and open compensation.
- Step 8.** Press the **OK** button in the Calibration/Compensation Wizard Setting dialog box to end the calibration and compensation wizard setting.

NOTE

The three Rdc limit values set as examples in Figure 6-24 are the setting values when 50-Ω load is used. For guidelines on determining the three Rdc limit values, see the chapter “Preparations for Accurate Measurements” in the *Programming Manual*.

2. How to execute calibration and compensation

- Step 1.** Press the **CAL WIZARD** key in the Cal/Compen softkey menu to start the calibration and compensation wizard.
- Step 2.** Execute calibration and compensation as prompted by the instructions on the screen.

When calibration and compensation data measurement is executed, the respective DC resistance measurement values are shown in the wizard screen (lower part). If the Rdc does not exceed the limit set in “1. Setting the limit for DC resistance (Rdc)” on page 151, a blue mark (●) appears to the left of the DC resistance measurement value (Figure 6-25).

Figure 6-25

Checking calibration and compensation task errors with DC resistance measurement value

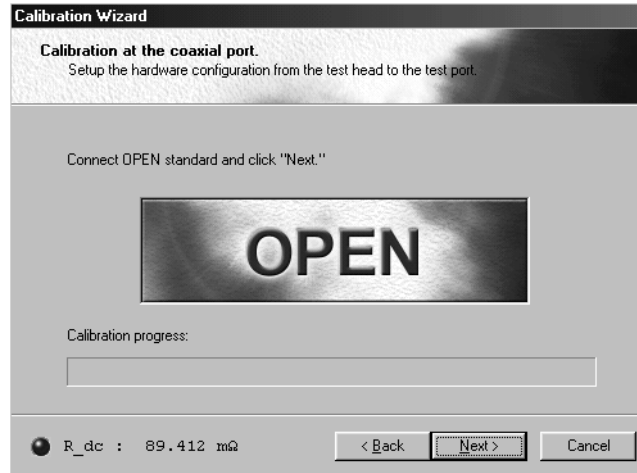

Calibration and Compensation
Preventing Mistakes During Execution of Calibration and Compensation

7 Executing Measurements and Displaying Results

This chapter describes how measurements are performed and how the measurement results are displayed by the 4287A.

Connecting the DUT

When using a dedicated test fixture, see the operation manual of the test fixture for details on how to connect the DUT.

Selecting Single Point Measurement or List Measurement

When the setup display appears, press the **[Meas View]** key on the front panel to display either the single point measurement display (Figure 7-1) or the list measurement display (Figure 7-2). After that, pressing the **[Meas View]** key toggles between the single point measurement display and the list measurement display.

Figure 7-1

Single point measurement display

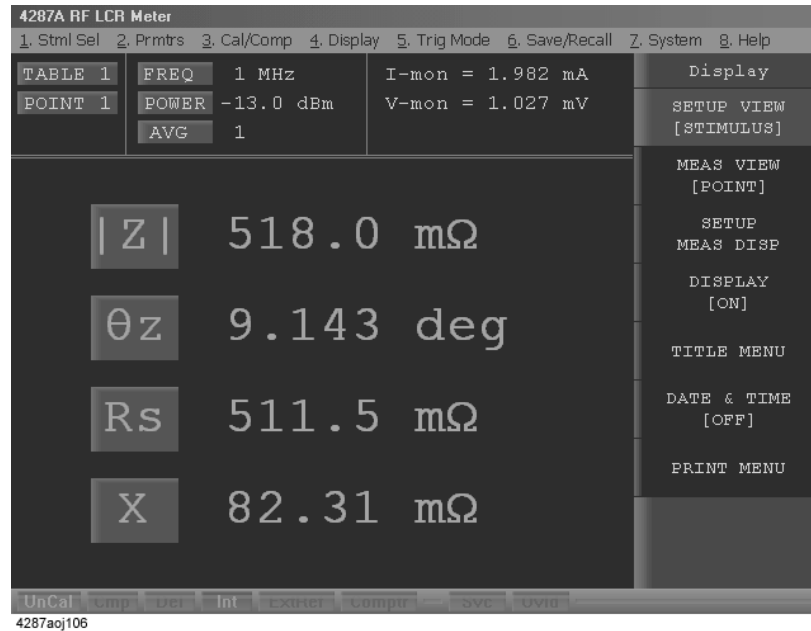
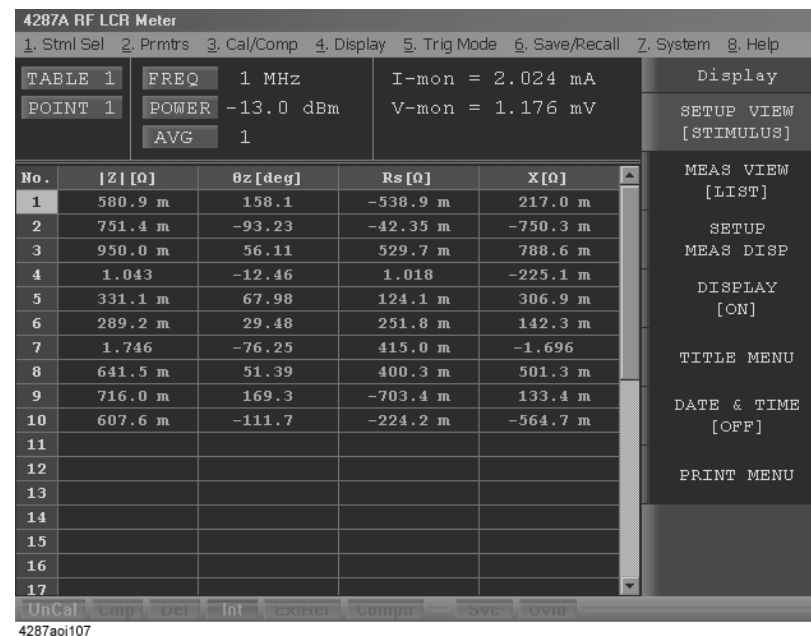

Figure 7-2

List measurement display



How to Select the Measurement Point Table

Follow these steps to select the measurement point table according to “How to Set the Measurement Point” on page 103.

- Step 1.** Press the **[Stim Select]** key on the front panel to display the Stim Select softkey menu.
- Step 2.** Select **TABLE No. []** from the softkey menu to display the table number selection softkey menu.
- Step 3.** Select the desired measurement point table from **Tables 1 to 8** in the softkey menu.

NOTE

Instead of performing the key operation **[Stim Select] - TABLE No. []** as described above, you can use the mouse to click the table number area (“3. Table number” on page 85) in the upper-left corner of the screen to display the table number selection softkey menu.

Selection of Measurement Point

Select the measurement point in the single point measurement display as follows:

- Step 1.** Press the **[Stim Select]** key in the measurement block to display the Stim Select softkey menu.
- Step 2.** Select the **POINT No. []** key from the softkey menu to display the POINT No.[] softkey menu.
- Step 3.** Select the measurement point number from the softkey menu.

NOTE

Only the measurement points set in the selected measurement point table are listed in the POINT No.[] softkey menu.

Instead of performing the key operation **[Stim Select] - POINT No. []** as described above, you can use the mouse to click the measurement point number area (“4. Measurement point number” on page 85) in the upper-left corner of the screen to display the POINT No.[] softkey menu.

The list measurement display allows you to select the measurement point in the same manner. In this case, the selected measurement point number in “3. Measurement point number/measurement frequency” on page 93 is highlighted, and the following values for the selected measurement point are shown at the top of the display: “1. Measurement point number” on page 89, “6. Measurement frequency” on page 85, “7. Oscillator level (power)” on page 86, “8. Averaging factor” on page 86, “9. Test signal current level monitor value” on page 86, and “10. Test signal voltage level monitor value” on page 86.

Selection of Measurement Parameters in Single Point Measurement Display

In the single point measurement display, a maximum of four parameters can be simultaneously displayed for the selected measurement point. Follow these steps to set the measurement parameters.

- Step 1.** Press the **[Prmtr]** key of the measurement block to display the Prmtrs softkey menu.
- Step 2.** Select the **SETUP MEAS PRMTRS** key from the softkey menu to display the SETUP MEAS PRMTRS softkey menu.
- Step 3.** Select the desired measurement parameter number from the softkey menu (**PRMTR-1 []** to **PRMTR-4 []**), and the measurement parameter selection softkey menu for the selected measurement parameter number will appear.
- Step 4.** Select the desired measurement parameter from the softkey menu.

Softkey label	Measurement parameter
Z	Absolute value of impedance
Y	Absolute value of admittance
Ls	Equivalent series inductance
Lp	Equivalent parallel inductance
Cs	Equivalent series capacitance
Cp	Equivalent parallel capacitance
R	Equivalent series resistance
Rs	Equivalent series resistance
Rp	Equivalent parallel resistance
Q	Quality factor
D	Dissipation factor
X	Equivalent series reactance
G	Equivalent parallel conductance
B	Equivalent parallel susceptance
θ_z (rad)	Impedance phase (radian)
θ_z (deg)	Impedance phase (deg.)
θ_y (rad)	Admittance phase (radian)
θ_y (deg)	Admittance phase (deg.)

NOTE

Instead of performing the key operation **[Prmtr] - SETUP MEAS PRMTRS - PRMTR-1** to **PRMTR-4** described above, it is also possible to display the measurement parameter

Executing Measurements and Displaying Results

Selection of Measurement Parameters in Single Point Measurement Display

selection softkey menu for each measurement parameter number by directly clicking on the large letters that symbolize each of the four parameters (the measurement parameter area of “16. Measurement parameter/measurement value” on page 88) Then parameter selection can be made in the softkey menu as described above.

Selection of Display Parameters in List Measurement Display

In the list measurement display, a maximum of four parameters can be simultaneously displayed for the listed measurement points. Follow these steps to set the list display parameters.

- Step 1.** Press the **[Prmtr]** key in the measurement block to display the parameter setup softkey menu in the list measurement display.
- Step 2.** Select the **SETUP LIST PRMTRS** key from the softkey menu to display the list display parameter setup softkey menu.
- Step 3.** Select the desired list display label (**LABEL-1 []** to **LABEL-4 []**) from the softkey menu, and the display parameter selection softkey menu for the selected label will appear.
- Step 4.** Select the desired display parameter from the softkey menu.

Softkey label	List display parameter
PRMTR-1 *1	The measurement parameter set as measurement parameter 1
PRMTR-2 *1	The measurement parameter set as measurement parameter 2
PRMTR-3 *1	The measurement parameter set as measurement parameter 3
PRMTR-4 *1	The measurement parameter set as measurement parameter 4
V-mon	Test signal voltage level monitor value
I-mon	Test signal current level monitor value
FREQ	Measurement frequency
AVG	Averaging factor
POWER	Test signal level (power)
R_dc	DC resistance measurement value

*1. The four measurement parameters set to show up on the single point measurement display are indicated as softkey labels in brackets.

NOTE

Instead of performing the key operation **[Prmtr] - SETUP LIST PRMTRS - LABEL-1 []** to **LABEL-4 []** as described above, you can directly click on a list display parameter's column heading ("2 to 5. Labels 1 to 4" on page 89) on the display; this immediately displays the selected label's parameter selection softkey menu.

Figure 7-3 Example of setting with measurement frequency, $|Z|$, θ_z (deg), and test signal current level monitor values used as list display parameters

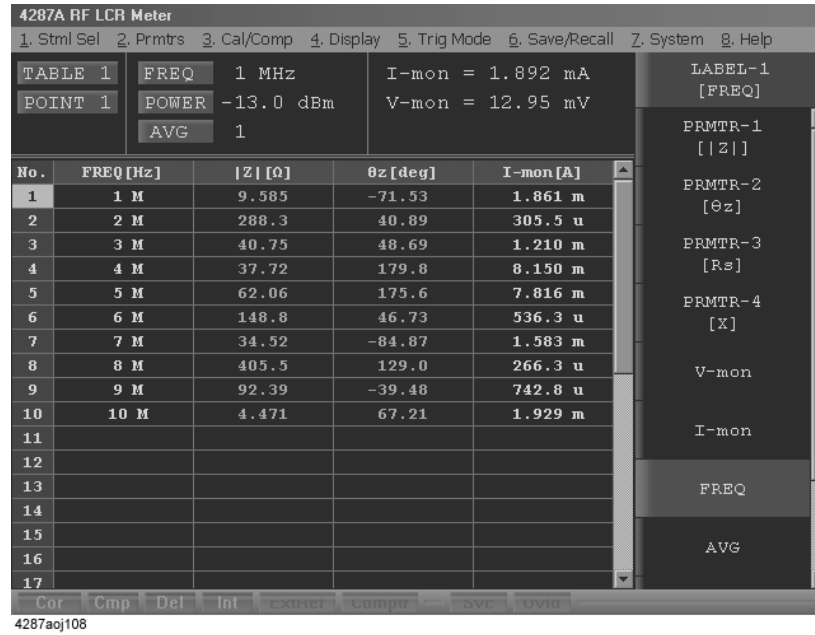

7. Executing Measurements and Displaying Results

Setting How the Instrument Displays Measurement Results (Enabling/Disabling Deviation Measurement Mode)

You can have the instrument display measurement results as absolute values or as deviations relative to the reference value (deviation measurement mode). You can change this setting for each of the measurement parameters 1 through 4. In deviation mode, you can set the instrument to display deviations as they are (**Deviation** mode) or as percentages relative to the reference value (**% Dev.** mode). When the deviation measurement mode is turned on, Δ symbol is displayed at the left of the measurement parameter.

Figure 7-4

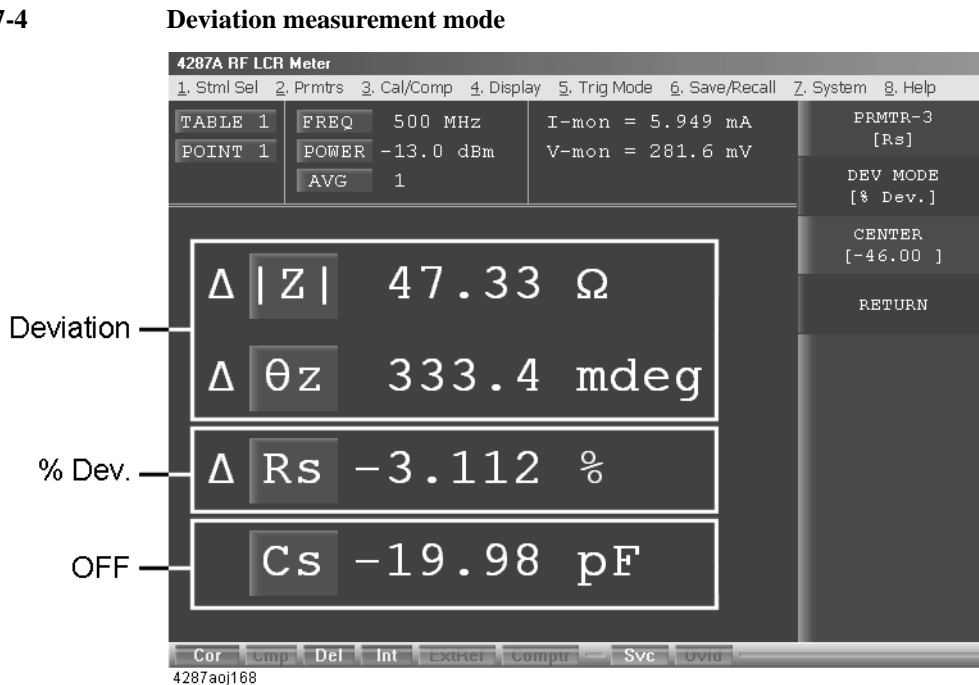

How the instrument displays measurement results differs according to the modes, as summarized in the table below.

deviation measurement mode	OFF	Deviation	% Dev.
How measurement results are displayed	<i>Meas</i>	<i>Meas - Ref</i>	$\frac{Meas - Ref}{Ref} \times 100$

where *Meas* and *Ref* mean the following:

Meas : Measured value

Ref : Reference value ([Prmtr] - SETUP DEVIATION - PRMTR-1 [] - PRMTR-4 [] - CENTER)

NOTE

When you are testing DUTs while using the bin sorting function, the instrument always displays measurement results as they are, regardless of the above settings. See Figure 6-5, “4287A’s data processing flow” in the *programming manual*.

Executing Measurements and Displaying Results
**Setting How the Instrument Displays Measurement Results
(Enabling/Disabling Deviation Measurement Mode)**

Follow these steps to set the deviation measurement mode.

- Step 1.** Press the **[Prmtr]** key in the measurement block to display the parameter setup softkey menu in the list measurement display.
- Step 2.** Select the **SETUP DEVIATION** key from the softkey menu to display the deviation setup softkey menu.
- Step 3.** Select the desired parameter label (**PRMTR-1 []** to **PRMTR-4 []**) from the softkey menu, and the deviation setup softkey menu for the selected label will appear.
- Step 4.** Press the **DEV MODE** key in the softkey menu to select the mode (the setting toggles with each press of the button).

Softkey Label	Deviation measurement mode
DEV MODE [OFF]	OFF
DEV MODE [Deviation]	ON (absolute deviation mode)
DEV MODE [% Dev.]	ON (percent deviation mode)

- Step 5.** Press the **CENTER** key in the softkey menu, and enter the reference value when you select **Deviation** or **% Dev.**.

Hiding the Screen Display

The screen display of measurement results, softkey menu and instrument status can be hidden with only the menu bar left visible on the screen. If you hide the screen display, it is not updated; this allows you to minimize measurement time. See Table 7-2 on page 168 for the times required to complete each task under different screen conditions.

NOTE For how to perform the instruction “press the key (softkey) in the softkey menu” mentioned in the procedure, see “13. Softkeys” on page 87.

- Step 1.** Press the **[Display]** key on the front panel to display the Display softkey menu.
- Step 2.** Press the **Display []** key in the softkey menu to turn the screen display ON or OFF (the setting toggles with each press of the button).

NOTE If the screen display is turned off, the softkey menu is not visible. To return the screen display to ON, use the mouse to select **4. Display - 4. DISPLAY [OFF]** from the menu bar. You can alternately press the **[Preset]** key on the front panel to return the 4287A settings to the preset condition (in the preset condition, the screen display is ON).

Softkey Label	Screen Display Status
DISPLAY [ON]	ON
DISPLAY [OFF]	OFF

Figure 7-5

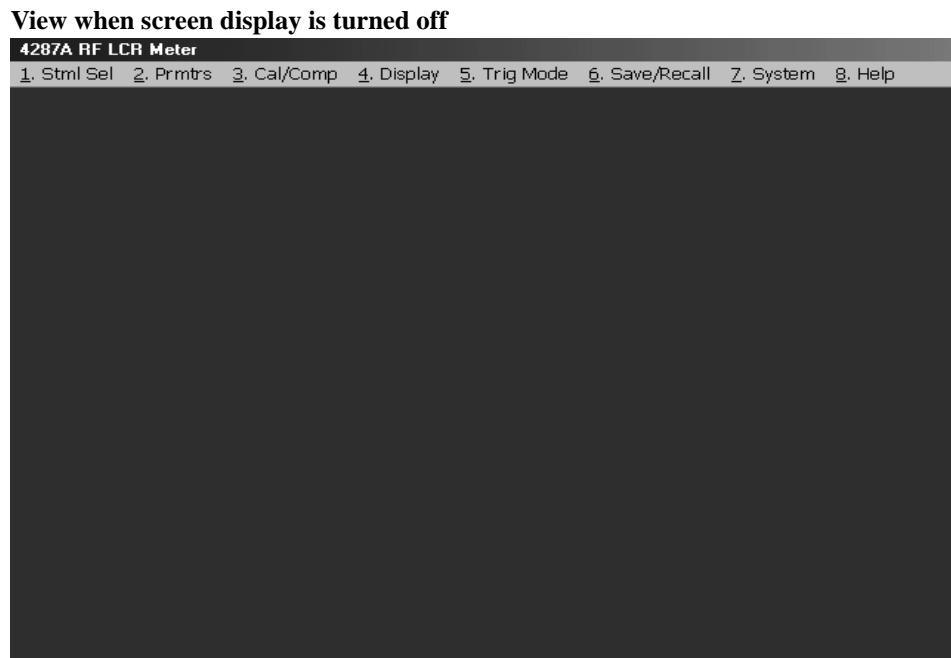

Turning ON/OFF Update the LCD Display View

The update function of the LCD display view can be turned ON/OFF.

NOTE

For how to perform the instruction “press the key (softkey) in the softkey menu” mentioned in the procedure, see “13. Softkeys” on page 87.

- Step 1.** Press the **[System]** key on the front panel to display the System softkey menu.
- Step 2.** Press the **SERVICE MENU** key in the softkey menu to display the SERVICE MENU softkey menu.
- Step 3.** Press the **UPDATE DISPLAY []** key in the softkey menu to turn the update of the LCD display ON or OFF (the setting toggles with each press of the button).

Softkey Label	Display Status
UPDATE DISPLAY [ON]	ON (display contents are updated)
UPDATE DISPLAY [OFF]	OFF (display contents are not updated)

When the update of the LCD display is set to OFF, updating of the displayed measurement parameters is restricted to measurement results. This setting can be used to minimize the internal processing time. See Table 7-2 on page 168 for details of typical task times.

NOTE

With the Agilent 4287A, updating a softkey label while update of the view on the display is off, is not guaranteed.

However, in Firmware Rev. 1.20 and later, amendment was made so that only the view of the **UPDATE DISPLAY []** softkey is updated even when update of the view on the display is turned off.

Thus, when update of the view on the display is turned off by operating the **[System] - SERVICE MENU - UPDATE DISPLAY [ON]** keys, the softkey view immediately changes to **UPDATE DISPLAY [OFF]**.

Table 7-1 Display contents when the update of the screen display is turned OFF

Display contents not updated	Title / Error message display Measurement condition display Instrument status display
Display contents updated	Each measurement parameter I / V monitor

Figure 7-6 View when the update of the screen display is turned off

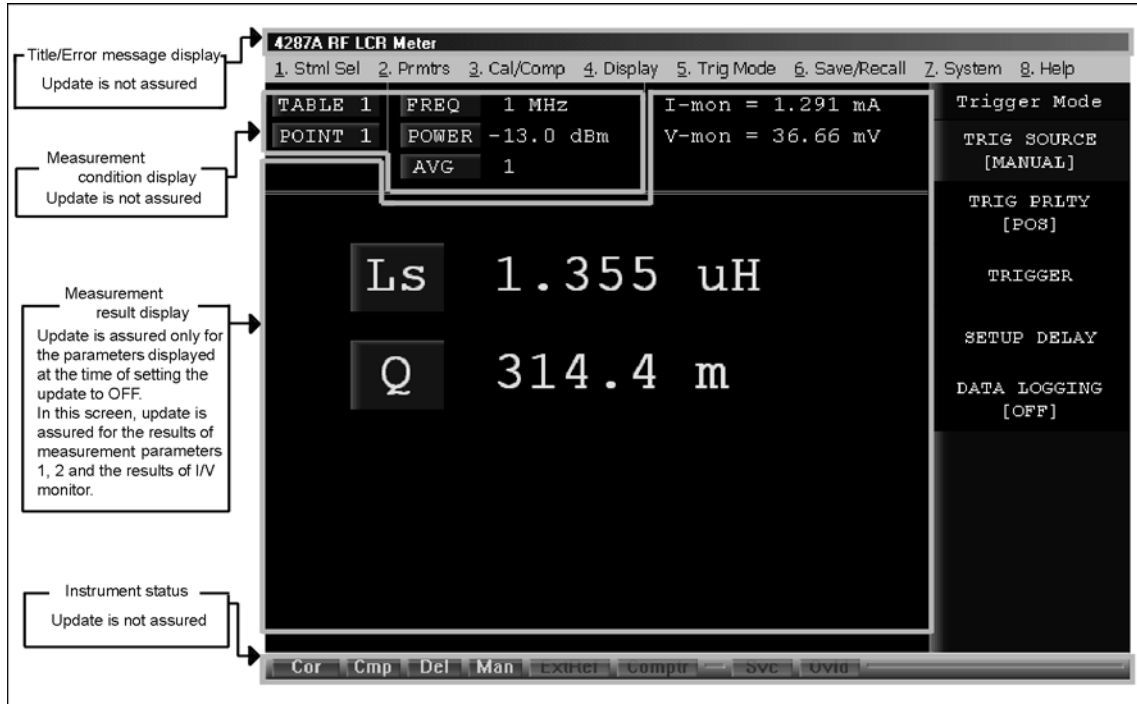

Table 7-2 Time of each task (typical values)

Measurement sequence	DISP:OFF	DISP:ON	
		UPDATE:ON	UPDATE:OFF
Setup time of READ?	5.3 ms	33.0 ms	5.6 ms
Time from TRIG-EOM	Time from T2 to T5 (11.1 ms max)		
Data acquisition time	3.2 ms	3.2 ms	3.2 ms
Display time + internal processing time	0 ms	10.3 ms	10.3 ms

Conditions:

Ls-Q measurement, single point measurement (LIST measurement), Rdc measurement, comparator OFF, Measurement signal level monitor ON.

Measurement instruments:

Host computer: i486DX4, 100 MHz / 82335B GPIB Card
Data acquisition time is transfer time using ASCII format.

NOTE

When performing measurements with the screen display set to ON, there are several factors that need to be considered. Therefore, make the most appropriate selection for the instrument settings by taking the following points into account.

1. When the screen display is set to perform updates (UPDATE:ON) and a GPIB command is sent to the instrument, the instrument will perform processes to update its

screen regardless of which command is executed.

2. The display time is much shorter for the list measurement display than for the single point measurement display
3. The display time becomes shorter as the number of display parameters decreases.
4. If possible, set the screen display to not perform updates (UPDATE:OFF). This minimizes the time needed to update the screen. For more details, refer to Table 12-4.

Table 7-3

Required measurement conditions and recommended settings

Required measurement conditions		Recommended settings for shortest measurement time		
Required measurement display parameters	GPIB command(s)	Screen display (DISP)	Display mode	Screen display update (UPDATE)
None	Send or None	OFF	Not relevant	Not relevant
All	Send	ON	List measurement	ON
All	None	ON	List measurement	ON
Measurement results only	Send	ON	List measurement	OFF
Measurement results only	None	ON	List measurement	OFF

Executing Measurements and Displaying Results
Turning ON/OFF Update the LCD Display View

8 **Sorting According to Measurement Results**

This chapter describes the BIN sort functions for sorting parts based on the obtained measurements.

Overview of BIN Sort Function

The BIN sort function of the Agilent Technologies 4287A is designed to determine, based on the obtained measurement data, the BIN where a DUT (device under test) should be placed according to the preset sorting conditions. By using this function, the result is indicated on the display and signals are sent to the handler interface.

The BIN sort function can be used for two purposes: (1) for manual measurement (Figure 8-1), and (2) for automatic sorting by a handler (automatic sorter) (Figure 8-2).

Figure 8-1

Parts sorting by manual measurement

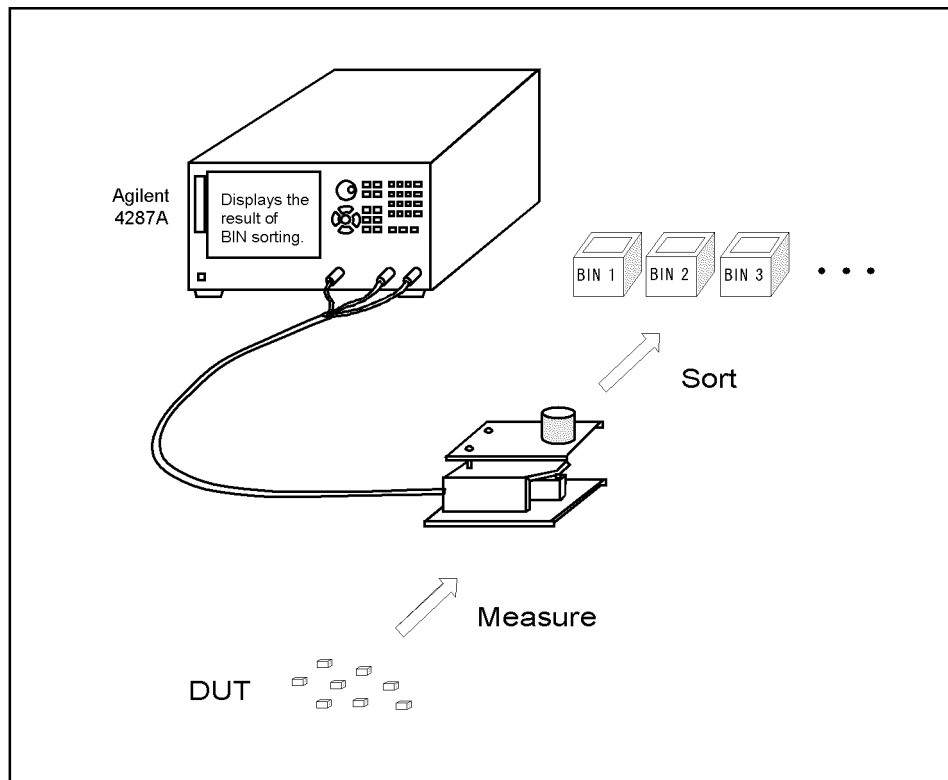

4287a0e033

Figure 8-2 Parts sorting by automatic sorter

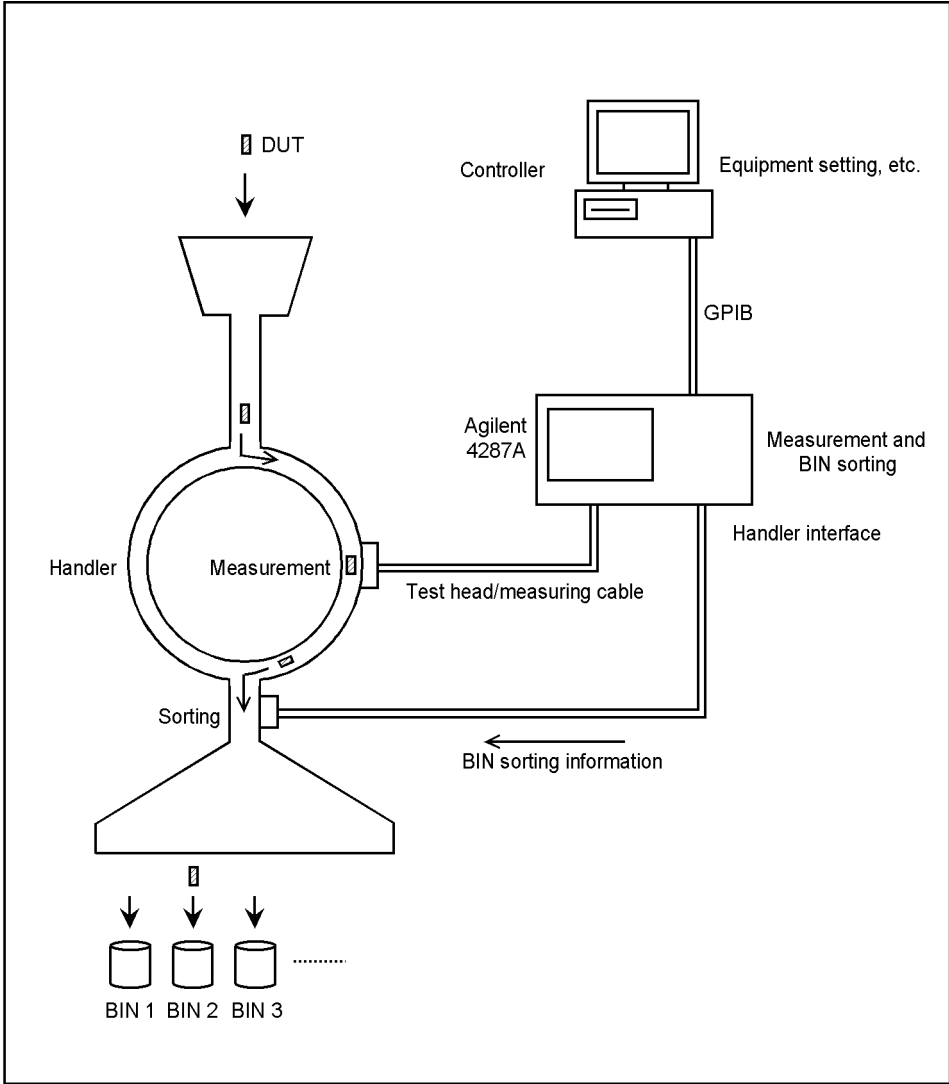

8. Sorting According to Measurement Results

Concept of setting 4287A BINs

Each BIN sorting condition based on the obtained measurements is set according to the principles given below and illustrated in Table 8-1.

- A maximum of 13 BINs can be set for each measurement point table (unused BINs are turned off).
- Bins are sequentially evaluated from BIN 1 to BIN 13. The first BIN meeting the appropriate conditions is selected in sorting. For details, see “Internal flow of BIN sort judgment” on page 176.
- Each BIN can be assigned a maximum of four sorting conditions. **Only the BINs meeting all of these preset sorting conditions** can be selected in sorting.
- Four sorting conditions—measurement point (measurement point number), measurement parameter, limit mode and reference value—are set as BIN range setting conditions common to all BINs.
- Settings for each BIN and for each sorting condition include the upper limit value, lower limit value, and BIN range mode.
- Even after sorting conditions have been set, each BIN can be turned on (active) or off (inactive, where the BIN is assumed to be non-existent) if required. Furthermore, for each BIN under each sorting condition, the condition setting can be turned on (active) or off (inactive and regarded as meeting the conditions at all times).
- Bins assigned given numbers (for example, BINs 6 to 13) can be specified as faulty BINs. If a BIN is selected as faulty as a result of BIN sorting, its BIN number is output to the handler interface together with the result of OUT_OF_GOOD_BINS.
- If devices cannot be sorted to any of the preset BINs, only the result of OUT_OF_GOOD_BINS is output and the BIN number is not output.

Table 8-1 Concept of 4287A BIN sort setting (set items for each table)

	Sorting condition 1	Sorting condition 2	Sorting condition 3	Sorting condition 4
	Measurement point number Measurement parameter Limit mode Reference value	Measurement point number Measurement parameter Limit mode Reference value	Measurement point number Measurement parameter Limit mode Reference value	Measurement point number Measurement parameter Limit mode Reference value
BIN 1 (allows setting ON/OFF)	Upper limit value Lower limit value BIN range mode	Upper limit value Lower limit value BIN range mode	Upper limit value Lower limit value BIN range mode	Upper limit value Lower limit value BIN range mode
BIN 2 (allows setting ON/OFF)	Upper limit value Lower limit value BIN range mode	Upper limit value Lower limit value BIN range mode	Upper limit value Lower limit value BIN range mode	Upper limit value Lower limit value BIN range mode
BIN 3 (allows setting ON/OFF)	Upper limit value Lower limit value BIN range mode	Upper limit value Lower limit value BIN range mode	Upper limit value Lower limit value BIN range mode	Upper limit value Lower limit value BIN range mode
:	:	:	:	:
BIN 13 (allows setting ON/OFF)	Upper limit value Lower limit value BIN range mode	Upper limit value Lower limit value BIN range mode	Upper limit value Lower limit value BIN range mode	Upper limit value Lower limit value BIN range mode

- Measurement point number** Selected from the measurement points set according to the measurement point setup table. This is set as a measurement point dedicated to BIN sorting, separately from the selection of the measurement point on the display (single point measurement display or list measurement display) used to indicate the measurement value.
- Measurement parameter** As with the setting of the measurement point, set as a measurement parameter dedicated to BIN sorting, separately from the selection of the measurement parameter on the display (single point measurement display or list measurement display) used to indicate the measurement value.
- Limit mode** The mode of selecting the format for inputting limit values (upper limit value and lower limit value) for each BIN. This mode is selected from three options: absolute mode (ABS: setting the limit value as an absolute value), percentage mode (PCNT: setting the limit value as a percentage of the reference value), and deviation mode (DEV: setting the limit value as a difference from the reference value).
- Reference value** The reference value used when percentage mode or deviation mode is selected as the limit mode.
- Bin ON/OFF** Allows the BIN to be turned on (active) and off (inactive). When turned off, the relevant BIN is inactive (the BIN is regarded as non-existent).
- Upper limit value** An upper limit value to determine the range of a BIN. The upper limit value must be equal to or greater than the lower limit value.
- Lower limit value** A lower limit value to determine the range of a BIN. The lower limit value must be equal to or less than the upper limit value.
- BIN range mode** The mode of setting the BIN range according to the limit values (upper limit value and lower limit value). This mode is selected from three options: In (BIN range at minimum equal to the lower limit value and at maximum equal to the upper limit value or any range within these values), Out (BIN range at maximum equal to or less than the lower limit value or at minimum equal to or greater than the upper limit value), and Off (limit values are irrelevant and entire range is set as BIN range).

Internal flow of BIN sort judgment

The BIN sort judgment is made according to the flow shown in Figure 8-3.

Figure 8-3 Internal flow of BIN sort judgment by 4287A

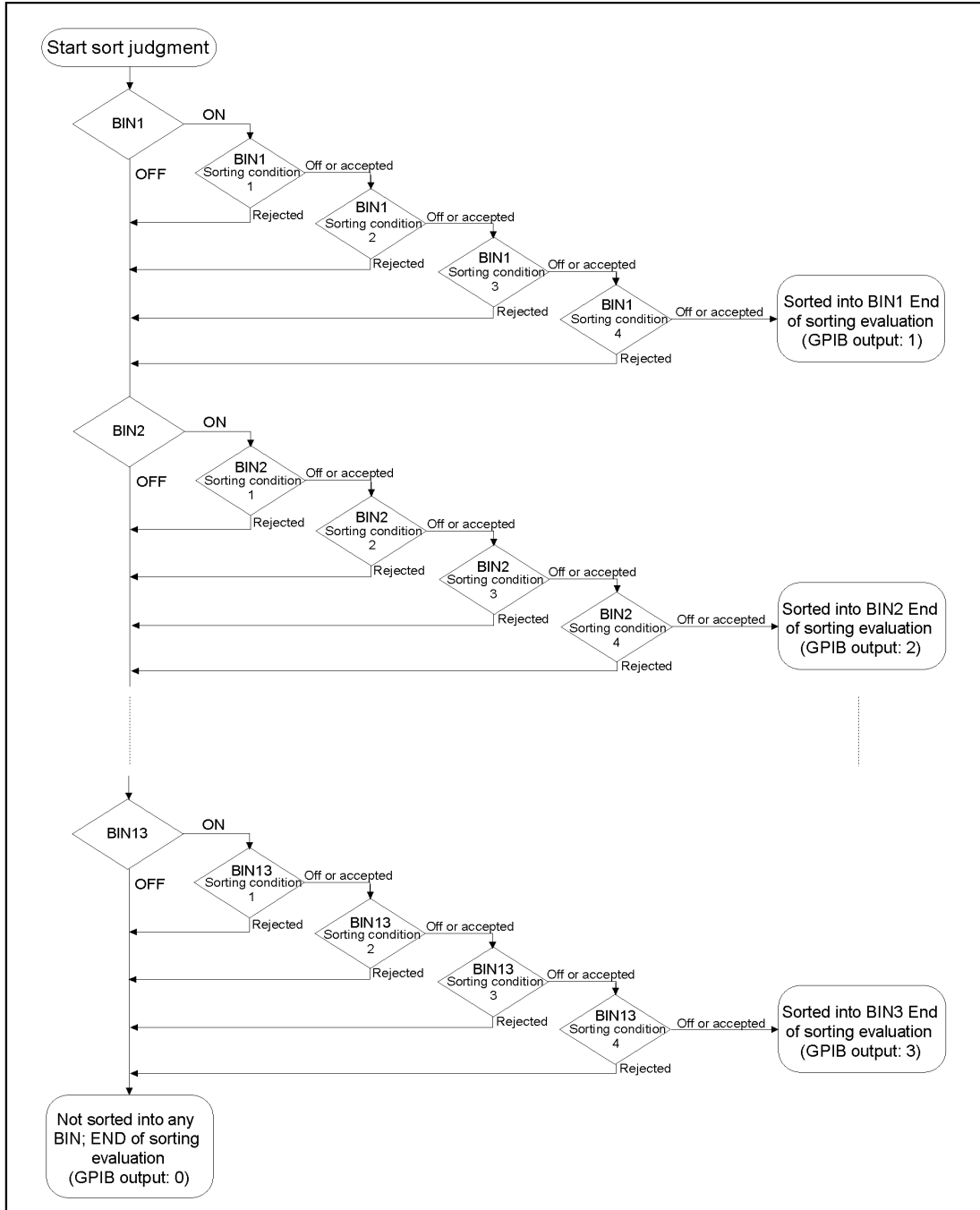

4287ace034

Setting Measurement Point

The following describes how to set the measurement point for BIN sorting under each sorting condition (1 to 4).

NOTE

To set the conditions for BIN sorting, the required measurement points should have been set in the measurement point setup display. If they were not, set the required measurement points according to Chapter 5, “Setting Measurement Conditions,” on page 101.

Setting of measurement points in BIN sorting is independent of selection of measurement points in the measurement display (single point measurement or list measurement).

- Step 1. Press the **[Setup View]** key in the measurement block until the BIN SORT setup display appears (Figure 8-4).

Figure 8-4

BIN sorting setup display

Table1	Stimulus	Condition1	Condition2
RdcTest:	Stimulus	(1) 1.0000 MHz	(1) 1.0000 MHz
UP 10.00 kΩ	Parameter	Z	θz(deg)
LO 0.000 Ω	Mode	ABS	ABS
	Nominal	-----	-----
BIN 1	UpperLimit	0.00000 Ω	0.00000 deg
OFF	LowerLimit	0.00000 Ω	0.00000 deg
	In/Out	All	All
BIN 2	UpperLimit	0.00000 Ω	0.00000 deg
OFF	LowerLimit	0.00000 Ω	0.00000 deg
	In/Out	All	All
BIN 3	UpperLimit	0.00000 Ω	0.00000 deg
OFF	LowerLimit	0.00000 Ω	0.00000 deg
	In/Out	All	All
BIN 4	UpperLimit	0.00000 Ω	0.00000 deg
OFF	LowerLimit	0.00000 Ω	0.00000 deg
	In/Out	All	All
BIN 5	UpperLimit	0.00000 Ω	0.00000 deg
OFF	LowerLimit	0.00000 Ω	0.00000 deg
	In/Out	---	---

- Step 2. Click with the mouse on the desired table number for BIN sort setting in the tool bar at the bottom of the display.
- Step 3. Click in the measurement point (stimulus) cell in the sorting condition to be set (one of conditions 1 to 4).
- Step 4. Click the down arrow (▼) at the right edge of the cell.
- Step 5. Click the desired measurement point from the drop-down list box to select it (Figure 8-5).

Sorting According to Measurement Results
Setting Measurement Point

Figure 8-5

Selection of measurement point as sorting condition 1

Table1	Stimulus	Condition1	Condition2
RdcTest:	Stimulus	(3) 100.00 MHz	(1) 1.0000 MHz
UP 10.00 kΩ	Parameter	(1) 1.0000 MHz	θz(deg)
LO 0.000 Ω	Mode	(2) 10.000 MHz	ABS
	Nominal	(3) 100.00 MHz	-----
BIN 1	UpperLimit	0.00000 Ω	0.00000 deg
OFF	LowerLimit	0.00000 Ω	0.00000 deg
	In/Out	All	All
BIN 2	UpperLimit	0.00000 Ω	0.00000 deg
OFF	LowerLimit	0.00000 Ω	0.00000 deg
	In/Out	All	All
BIN 3	UpperLimit	0.00000 Ω	0.00000 deg
OFF	LowerLimit	0.00000 Ω	0.00000 deg
	In/Out	All	All
BIN 4	UpperLimit	0.00000 Ω	0.00000 deg
OFF	LowerLimit	0.00000 Ω	0.00000 deg
	In/Out	All	All
BIN 5	UpperLimit	0.00000 Ω	0.00000 deg
OFF	LowerLimit	0.00000 Ω	0.00000 deg

NOTE

The drop-down list box allows a maximum of ten lines to appear in one display. If there are more than ten lines, click on ▲ in the upper-right or ▼ in the lower-right part of the list box or use the scroll thumb to scroll the list.

Setting Measurement Parameter

After setting the measurement point number, select the measurement parameter for BIN sorting.

NOTE

Similar to setting the measurement point, selecting the measurement parameter in BIN sorting is independent of the selection of the measurement parameter in the measurement display (single point measurement or list measurement).

- Step 1.** Click with the mouse in the measurement parameter cell in the sorting condition to be set (one of conditions 1 to 4).
- Step 2.** Click the down arrow (▼) at the right edge of the cell.
- Step 3.** Click the desired measurement parameter from the drop-down list box to select it (Figure 8-6).

BIN sort measurement parameter	Definition
Ls	Equivalent series inductance
Lp	Equivalent parallel inductance
Cs	Equivalent series capacitance
Cp	Equivalent parallel capacitance
Rs	Equivalent series resistance
Rp	Equivalent parallel resistance
Q	Quality factor
D	Dissipation factor
G	Equivalent parallel conductance
B	Equivalent parallel susceptance
X	Equivalent series reactance
Z	Absolute value of impedance
Y	Absolute value of admittance
θ_z (rad)	Impedance phase (radian)
θ_z (deg)	Impedance phase (deg.)
θ_y (rad)	Admittance phase (radian)
θ_y (deg)	Admittance phase (deg.)

NOTE

Click on ▲ in the upper-right or ▼ in the lower-right part of the list box or use the scroll thumb to scroll the list.

Sorting According to Measurement Results
 Setting Measurement Parameter

Figure 8-6

Selection of measurement parameter for sorting condition 1

4287A RF LCR Meter
 1.File 2.Edit 3.View 4.Table

STIMULUS | CAL KIT | COMPEN KIT | COMPARATOR

Table1		Condition1	Condition2
RdcTest:	Stimulus	(3) 100.00 MHz	(1) 1.0000 MHz
UP 10.00 kΩ	Parameter	Ls	θz(deg)
LO 0.000 Ω	Mode	Z	ABS
	Nominal	Y	-----
BIN 1	UpperLimit	Ls	0.00000 deg
OFF	LowerLimit	Lp	0.00000 deg
	In/Out	Cs	All
BIN 2	UpperLimit	Cp	0.00000 deg
OFF	LowerLimit	Rs	0.00000 deg
	In/Out	Rp	0.00000 deg
BIN 3	UpperLimit	Q	All
OFF	LowerLimit	D	0.00000 deg
	In/Out	0.00000 Ω	0.00000 deg
BIN 4	UpperLimit	0.00000 Ω	All
OFF	LowerLimit	0.00000 Ω	0.00000 deg
	In/Out	All	All
BIN 5	UpperLimit	0.00000 Ω	0.00000 deg
OFF	LowerLimit	0.00000 Ω	0.00000 deg

1 2 3 4 5 6 7 8 EXIT

4287aoj111

Setting Limit Mode and Reference Value

Setting limit mode

This procedure determines the format used to set the upper and lower limits of the measurement values for BIN sorting.

- Step 1.** Click with the mouse in the BIN limit setting mode cell in the sorting condition to be set (one of conditions 1 to 4).
- Step 2.** Click the down arrow (▼) at the right edge of the cell.
- Step 3.** Click the desired limit mode from the drop-down list box to select it (Figure 8-3).

Limit mode	Definition
ABS	Absolute mode. The limits of each BIN are set as absolute values. If you select this mode, you do not need to set the reference value (nominal).
PCNT	Percentage mode. The limit value of each BIN is set as a percentage of the reference value.
DEV	Deviation mode. The limit value of each BIN is set as a difference with respect to the reference value. Use the same unit as that of the set measurement parameter.

Figure 8-7

Selection of limit mode for sorting condition 1

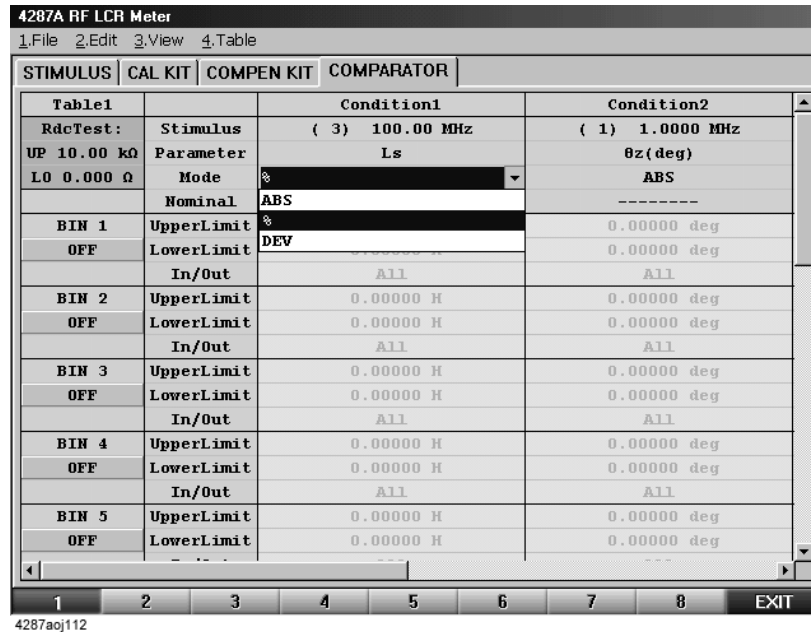

Setting reference value

When you select percentage mode (**PCNT**) or deviation mode (**DEV**) as the limit mode, you must set the reference value (Nominal).

NOTE

When you select absolute mode (**ABS**) as the BIN limit mode, you do not need to set the reference value (nominal). Actually, this value cannot be set in ABS mode.

- Step 1.** Click with the mouse in the reference value (Nominal) cell in the sorting condition to be set (one of conditions 1 to 4). (Before doing this, make sure the limit mode is set as PCNT or DEV.)
- Step 2.** Press the entry block numeric keys ([0] to [9]-[.]) to enter the reference value and then press the desired unit key ([G/n], [M/μ], [k/m], or [×1]).

To enter 50 nH, for example, press [5], [0], and then [G/n] (Figure 8-8).

Figure 8-8

Entering BIN limit setting reference value for sorting condition 1

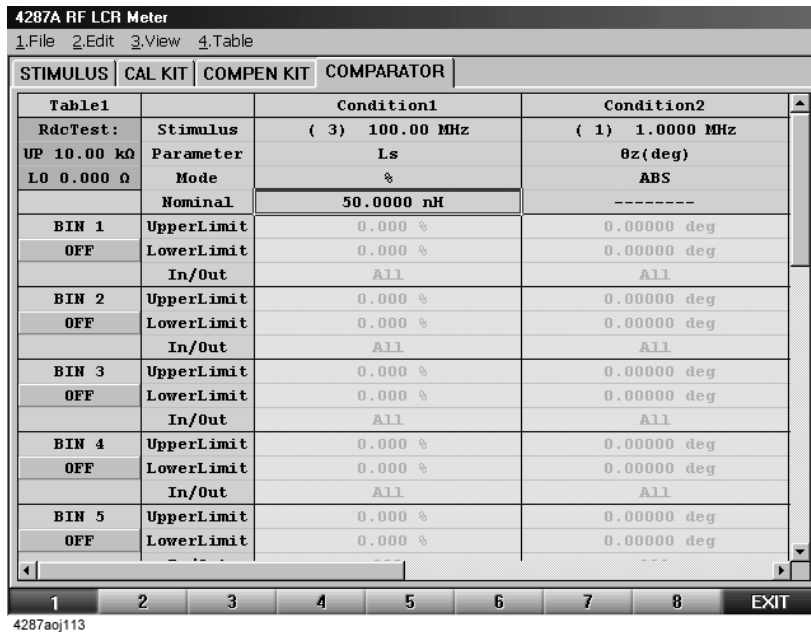

Setting BIN Range

Set the actual BIN range after setting the BIN range setting conditions according to “Setting Measurement Point” on page 177), “Setting Measurement Parameter” on page 179, and “Setting Limit Mode and Reference Value” on page 181.

Setting upper limit value

Follow these steps to set the BIN upper limit value.

- Step 1.** Click with the mouse the **OFF** button under the BIN to be set. This turns on the BIN and changes the button to **ON**.
- Step 2.** Click in the cell corresponding to the column of the desired sorting condition (one of conditions 1 to 4) on the row of the upper limit value of the BIN to be set.
- Step 3.** Press the entry block numeric keys (**[0]** to **[9]**[-][.]) to enter the upper limit value of the BIN to be set and then press the desired unit key (**[G/n]**, **[M/μ]**, **[k/m]**, or **[×1]**).

To set the upper limit value to 51 nH when the limit mode is in absolute mode, for example, press **[5]**, **[1]**, and then **[G/n]**.

To set the upper limit value to +1% of the reference value (Nominal) when the limit mode is in percentage mode, press **[1]** and then **[×1]**.(Figure 8-9)

Figure 8-9

Setting upper limit value of BIN 1

4287A RF LCR Meter			
1.File 2.Edit 3.View 4.Table			
STIMULUS		COMPARATOR	
Table1	Stimulus	Condition1	Condition2
RdcTest:	Parameter	(3) 100.00 MHz	(3) 100.00 MHz
UP 10.00 kΩ	Parameter	Ls	Q
LO 0.000 Ω	Mode	%	ABS
	Nominal	50.0000 nH	-----
BIN 1	UpperLimit	1 %	0.00000
OFF	LowerLimit	-----	0.00000
	In/Out	All	All
BIN 2	UpperLimit	0.000 %	0.00000
OFF	LowerLimit	0.000 %	0.00000
	In/Out	All	All
BIN 3	UpperLimit	0.000 %	0.00000
OFF	LowerLimit	0.000 %	0.00000
	In/Out	All	All
BIN 4	UpperLimit	0.000 %	0.00000
OFF	LowerLimit	0.000 %	0.00000
	In/Out	All	All
BIN 5	UpperLimit	0.000 %	0.00000
OFF	LowerLimit	0.000 %	0.00000

4287aoj114

Sorting According to Measurement Results
Setting BIN Range

Setting lower limit value

Follow these steps to set the lower limit value after setting the upper limit value of the BIN as follows:

- Step 1.** Click with the mouse in the cell corresponding to the column of the desired sorting condition (one of conditions 1 to 4) on the row of the lower limit value of the BIN to be set.
- Step 2.** Press the entry block numeric keys ([0] to [9][-.],) to enter the lower limit value of the BIN to be set and then press the desired unit key ([G/n], [M/μ], [k/m], or [×1]).

To set the lower limit value to 49 nH when the limit mode is in absolute mode, for example, press [4], [9], and then [G/n].

To set the lower limit value to -1% of the reference value (Nominal) when the limit mode is in percentage mode, press [-] and [1] and then [×1] (Figure 8-10).

Figure 8-10

Setting lower limit value of BIN 1

4287A RF LCR Meter			
1.File 2.Edit 3.View 4.Table			
STIMULUS		CAL KIT	COMPEN KIT
Table1		Condition1	Condition2
RdcTest:	Stimulus	(3) 100.00 MHz	(3) 100.00 MHz
UP 10.00 kΩ	Parameter	Ls	Q
LO 0.000 Ω	Mode	%	ABS
	Nominal	50.0000 nH	-----
BIN 1	UpperLimit	1.000 %	0.00000
OFF	LowerLimit	-1 %	0.00000
	In/Out		All
BIN 2	UpperLimit	0.000 %	0.00000
OFF	LowerLimit	0.000 %	0.00000
	In/Out	All	All
BIN 3	UpperLimit	0.000 %	0.00000
OFF	LowerLimit	0.000 %	0.00000
	In/Out	All	All
BIN 4	UpperLimit	0.000 %	0.00000
OFF	LowerLimit	0.000 %	0.00000
	In/Out	All	All
BIN 5	UpperLimit	0.000 %	0.00000
OFF	LowerLimit	0.000 %	0.00000
	In/Out	All	All

4287aoj115

Selecting BIN range mode

You can select whether the BIN range should be inside or outside of the set limit values (upper and lower limit values) or whether the BIN range should cover the entire range regardless of the limit values.

- Step 1.** Click with the mouse in the cell corresponding to the column of the desired sorting condition (one of conditions 1 to 4) on the In/Out row of the BIN to be set.
- Step 2.** Click the down arrow (▼) at the right edge of the cell.
- Step 3.** Click the desired BIN range mode from the drop-down list box to select it.

Bin range mode	Definition
In	Inside. This mode ensures that the BIN range is inside the set limit values (upper and lower limit values).
Out	Outside. This mode ensures that the BIN range is outside the set limit values (upper and lower limit values). Namely, the BIN is used when the result is equal to or greater than the upper limit value or equal to or less than the lower limit value.
All	The entire range. In this mode the BIN range covers the entire range regardless of the set limit values (upper and lower limit values). Namely, the system assumes that any measurement result is within the set range.

8. Sorting According to Measurement Results

Figure 8-11

Selecting BIN range mode

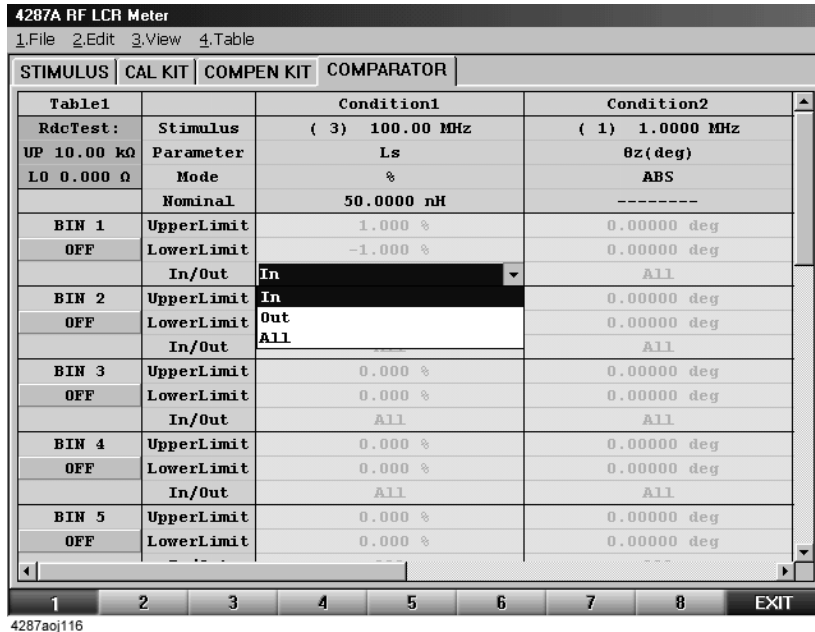

Setting BIN On and Off

In the presetting, all BINs are off (inactive), and the BIN is regarded as non-existent. This requires the BIN to be turned on (activated) either before or after setting the BIN range to make the new settings active. You can set the condition of a specific BIN and then turn it off temporarily. After that you can turn it on whenever required (the setting of the BIN range is not affected by turning the BIN on and off).

- Step 1.** Click with the mouse the ON/OFF button just below the BIN name button in the leftmost column of the BIN Sort setup table to turn the BIN on and off.

Figure 8-12

Example of BIN 1 turned on

4287A RF LCR Meter			
1.File 2.Edit 3.View 4.Table			
STIMULUS CAL KIT COMPEN KIT COMPARATOR			
Table1	Stimulus	Condition1	Condition2
RdcTest:	Stimulus	(3) 100.00 MHz	(1) 1.0000 MHz
UP 10.00 kΩ	Parameter	Ls	θz(deg)
LO 0.000 Ω	Mode	%	ABS
	Nominal	50.0000 nH	-----
BIN 1	UpperLimit	1.000 %	0.00000 deg
ON	LowerLimit	-1.000 %	0.00000 deg
	In/Out	In	All
BIN 2	UpperLimit	0.000 %	0.00000 deg
OFF	LowerLimit	0.000 %	0.00000 deg
	In/Out	All	All
BIN 3	UpperLimit	0.000 %	0.00000 deg
OFF	LowerLimit	0.000 %	0.00000 deg
	In/Out	All	All
BIN 4	UpperLimit	0.000 %	0.00000 deg
OFF	LowerLimit	0.000 %	0.00000 deg
	In/Out	All	All
BIN 5	UpperLimit	0.000 %	0.00000 deg
OFF	LowerLimit	0.000 %	0.00000 deg
	In/Out	All	All

1 2 3 4 5 6 7 8 EXIT

4287a0j117

Setting Faulty BIN (OUT OF GOOD BINS)

You can predetermine that BINs following the desired BIN number are faulty.

If a BIN is evaluated as faulty by BIN sorting, the result of OUT_OF_GOOD_BINS as well as the BIN number is output to the handler interface.

- Step 1.** Click with the mouse “**2. Edit**” on the menu bar.
- Step 2.** Click “**7. Out Of Good Bins**” from the menu.
- Step 3.** From the sub-menu, click an item for the lowest-order good BIN.

For example, selecting “**Out Of Good Bins: > Bin3**” sets BINs 1 to 3 as good and BINs 4 to 13 as not good. A red dotted line is drawn on the boundary between the lowest good BIN and the highest faulty BIN (Figure 8-13).

Figure 8-13

Setting BINs 4 and lower as faulty

4287A RF LCR Meter			
1.File 2.Edit 3.View 4.Table			
STIMULUS		CAL KIT	COMPEN KIT
COMPARATOR			
Table1		Condition1	Condition2
RdcTest:	Stimulus	(3) 100.00 MHz	(1) 1.0000 MHz
UP 10.00 kΩ	Parameter	Ls	θz(deg)
LO 0.000 Ω	Mode	%	ABS
	Nominal	50.0000 nH	-----
BIN 1	UpperLimit	1.000 %	0.00000 deg
ON	LowerLimit	-1.000 %	0.00000 deg
	In/Out	In	All
BIN 2	UpperLimit	2.000 %	0.00000 deg
ON	LowerLimit	-2.000 %	0.00000 deg
	In/Out	In	All
BIN 3	UpperLimit	3.000 %	0.00000 deg
ON	LowerLimit	-3.000 %	0.00000 deg
	In/Out	In	All
BIN 4	UpperLimit	4.000 %	0.00000 deg
ON	LowerLimit	-4.000 %	0.00000 deg
	In/Out	In	All
BIN 5	UpperLimit	5.000 %	0.00000 deg
ON	LowerLimit	-5.000 %	0.00000 deg
	In/Out	In	All

4287aoj118

8. Sorting According to Measurement Results

Setting Upper and Lower Limit Values for DC Resistance Measurement

When the DC resistance (Rdc) measurement is activated, the 4287A starts DC resistance measurement before impedance measurement. In this case, pass/fail evaluation is made according to the preset test limit after DC resistance measurement. If the result deviates from the test limit, the /RDC_OUT_OF_RANGE signal of the handler interface is activated and the DC resistance measurement result is displayed in red.

Use the following steps to set the upper and lower limit values for the DC resistance measurement.

- Step 1.** Click with the mouse in the DC resistance upper limit value cell (**UP x.xx Ω**) in the upper-left corner of the BIN sort setup table.
- Step 2.** Press the entry block numeric keys (**[0]** to **[9]**[-][.]) to enter the upper limit value of the DC resistance and then press the unit key (**[G/n]**, **[M/μ]**, **[k/m]**, or **[×1]**).

To set the upper limit value to 20 Ω, for example, press **[2]**, **[0]**, and then **[×1]** (Figure 8-14).

Figure 8-14

Setting upper limit value for DC resistance (Rdc)

4287A RF LCR Meter			
1.File 2.Edit 3.View 4.Table			
STIMULUS		CAL KIT	COMPEN KIT
Table1		Condition1	Condition2
RdcTest:	Stimulus	(3) 100.00 MHz	(1) 1.0000 MHz
	20 kΩ	Ls	θz (deg)
		%	ABS
	Nominal	50.0000 nH	-----
BIN 1	UpperLimit	1.000 %	0.00000 deg
ON	LowerLimit	-1.000 %	0.00000 deg
	In/Out	In	All
BIN 2	UpperLimit	2.000 %	0.00000 deg
ON	LowerLimit	-2.000 %	0.00000 deg
	In/Out	In	All
BIN 3	UpperLimit	3.000 %	0.00000 deg
ON	LowerLimit	-3.000 %	0.00000 deg
	In/Out	In	All
BIN 4	UpperLimit	4.000 %	0.00000 deg
ON	LowerLimit	-4.000 %	0.00000 deg
	In/Out	In	All
BIN 5	UpperLimit	5.000 %	0.00000 deg
ON	LowerLimit	-5.000 %	0.00000 deg
	In/Out	In	All

- Step 3.** Set the DC resistance lower limit value by clicking in its cell and then following the procedure of step 2.

Turning On BIN Sorting and Displaying the Result

When BIN sorting setup is completed, follow these steps to turn on the BIN sorting function.

- Step 1.** Press the **[System]** key in the Instrument State Block on the front panel to display the System softkey menu.
- Step 2.** Press the **COMPARATOR []** key in the softkey menu to turn ON/OFF the BIN sorting execution (the setting toggles with each press of the key).

Softkey Label	Display Status
COMPARATOR [ON]	ON (BIN sorting is executed)
COMPARATOR [OFF]	OFF (BIN sorting is not executed)

When BIN sorting is turned on, the BIN sorting result is displayed for each measurement in the BIN sorting result area in the upper left area of the display (Table 8-15).

Figure 8-15

BIN Sort Result Display

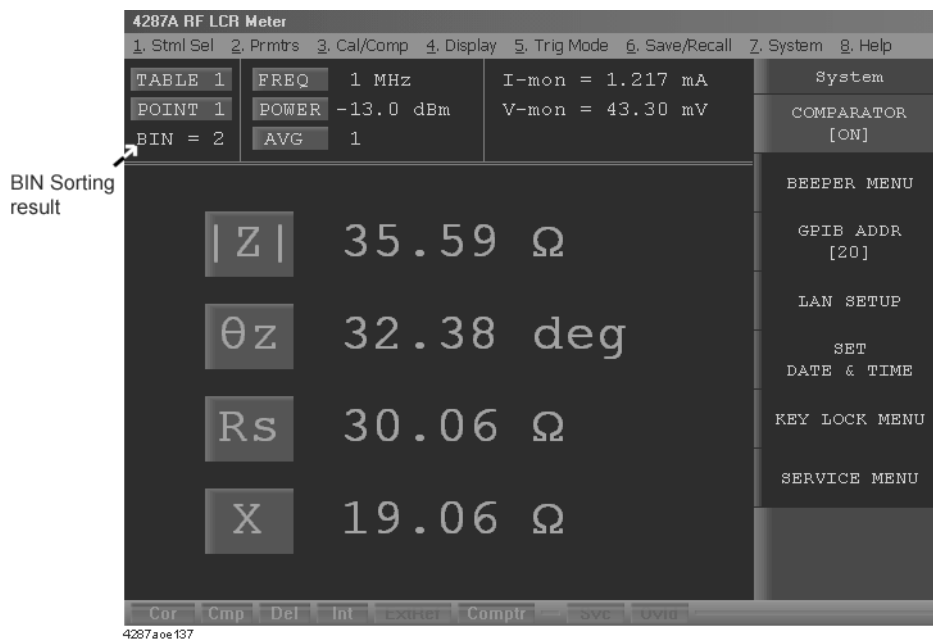

8. Sorting According to Measurement Results

NOTE

The figure displayed following “BIN =” is the BIN number as the BIN sort result. When the measurement result is not sorted in any of the BINs, “BIN = 0” is displayed. When Overload or Rdc limit deviation occurred, “BIN = 14” is displayed. When the measurement result is sorted in “Good Bins” defined by “Setting Faulty BIN (OUT OF GOOD BINS)” on page 187, the BIN sort result is displayed in white; when the measurement result is sorted in “Faulty Bins,” the BIN sort result is displayed in red.

Bin Count Function

Effective from Firmware Rev. 1.20 The Bin Count function counts the frequency by incrementing the bin count corresponding to the Bin Sorting result by 1 each time measurement ends. The frequency of each bin can be viewed on the display when necessary.

Turning on Bin Count

If Bin Count is turned on, the bin frequency corresponding to the result is incremented by 1 each time Bin Sorting is run by measurement.

Bin Count can be turned on using the following procedure:

- Step 1.** In the front panel Measurement Block, press the **[Prmtr]** key to display the Prmtrs softkey menu.
- Step 2.** In the softkey menu, press the **BIN COUNT MENU** to display the BIN COUNT MENU softkey menu.
- Step 3.** In the softkey menu, press the **COUNT []** key to turn on Bin Count.

softkey label	Status of Bin Count
COUNT[ON]	On
COUNT[OFF]	Off

NOTE Even when Bin Count is turned on, the counter value is unchanged unless Bin Sorting is actually run. For using the Bin Sorting function, refer to Chapter 8, "Sorting According to Measurement Results" in the Operation Manual.

Listing the BIN Count results

The Bin Count results can be listed on the LCD display by using the following procedure:

- Step 1.** In the front panel Measurement Block, press the **[Prmtr]** key to display the Prmtrs softkey menu.
- Step 2.** In the softkey menu, press the **BIN COUNT MENU** to display the BIN COUNT MENU softkey menu.
- Step 3.** In the softkey menu, press the **DISPLAY** key to list the BIN Count results (see Figure 8-16).

Figure 8-16

Bin Count Results dialog box

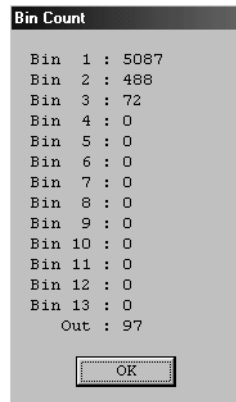

NOTE

To close the Bin Count Results dialog box, press the **OK** button.

The BIN Count results listed in the dialog box are those obtained when you pressed the **DISPLAY** softkey. If the contents of the bin count are updated because measurement and bin sorting are run when the dialog box is on display, you will have to close it once and then press the **DISPLAY** softkey again to redisplay it.

Initializing the contents of the bin counts to zero (resetting the counter)

The contents of all bin counts (i.e., value in the counter) can be initialized (resetting) to zero using the following procedure:

- Step 1.** In the front panel Measurement Block, press the **[Prmtr]** key to display the Prmtrs softkey menu.
- Step 2.** In the softkey menu, press the **BIN COUNT MENU** to display the BIN COUNT MENU softkey menu.
- Step 3.** In the softkey menu, press the **CLEAR** key to initialize the contents of all bin counts to zero.

Example of Settings for BIN Sorting

The following introduces an example of setting an actual BIN sort setting table. The sorting conditions to be set are shown in Table 8-2.

Table 8-2 **Sorting conditions**

BIN	Condition 1	Condition 2
	Measurement point number: 3 (100 MHz) Measurement parameter: Ls	Measurement point number: 3 (100 MHz) Measurement parameter: Q
BIN 1		
BIN 2		
BIN 3		
OUT OF BINS		

NOTE

When both Condition 1 and Condition 2 of Table 8-2 are met, the DUT is placed in the appropriate BIN.

In Table 8-2, “●” denotes that this point is included, and “○” denotes that this point is not included.

Perform the following steps to set these conditions in the 4287A.

Setting the measurement point number, measurement parameter, and BIN range setting mode for Condition 1

Step 1. Press the [Cmptr] key in the instrument state block (INSTR STATE) on the front panel to display the BIN sorting setup display (Figure 8-17).

Figure 8-17

BIN sorting setup display

Table1	Stimulus	Condition1	Condition2
RdcTest:	Stimulus	(1) 1.0000 MHz	(1) 1.0000 MHz
UP 10.00 kΩ	Parameter	Z	θz(deg)
LO 0.000 Ω	Mode	ABS	ABS
	Nominal	-----	-----
BIN 1	UpperLimit	0.00000 Ω	0.00000 deg
OFF	LowerLimit	0.00000 Ω	0.00000 deg
	In/Out	All	All
BIN 2	UpperLimit	0.00000 Ω	0.00000 deg
OFF	LowerLimit	0.00000 Ω	0.00000 deg
	In/Out	All	All
BIN 3	UpperLimit	0.00000 Ω	0.00000 deg
OFF	LowerLimit	0.00000 Ω	0.00000 deg
	In/Out	All	All
BIN 4	UpperLimit	0.00000 Ω	0.00000 deg
OFF	LowerLimit	0.00000 Ω	0.00000 deg
	In/Out	All	All
BIN 5	UpperLimit	0.00000 Ω	0.00000 deg
OFF	LowerLimit	0.00000 Ω	0.00000 deg
	In/Out	All	All

4287aaj120

Step 2. Use the following procedure to set the measurement point number for Condition 1.

- a. Click with the mouse the measurement point number (Stimulus) cell in the Condition 1 column to select the cell.
- b. Click the down-arrow ▼ that appears in the right side of the cell.
- c. In the drop-down list box that appears, click “(3) 100.00 MHz” (Figure 8-18).

Sorting According to Measurement Results
 Example of Settings for BIN Sorting

Figure 8-18 Setting the measurement point number (Stimulus) for Condition 1

Table1		Condition1	Condition2
RdcTest:	Stimulus	(3) 100.00 MHz	(1) 1.0000 MHz
UP 10.00 kΩ	Parameter	(1) 1.0000 MHz	θz(deg)
LO 0.000 Ω	Mode	(2) 10.000 MHz	ABS
	Nominal	(3) 100.00 MHz	-----
	UpperLimit	(4) 1.0000 GHz	
BIN 1	UpperLimit	0.00000 Ω	0.00000 deg
OFF	LowerLimit	0.00000 Ω	0.00000 deg
	In/Out	All	All
BIN 2	UpperLimit	0.00000 Ω	0.00000 deg
OFF	LowerLimit	0.00000 Ω	0.00000 deg
	In/Out	All	All
BIN 3	UpperLimit	0.00000 Ω	0.00000 deg
OFF	LowerLimit	0.00000 Ω	0.00000 deg
	In/Out	All	All
BIN 4	UpperLimit	0.00000 Ω	0.00000 deg
OFF	LowerLimit	0.00000 Ω	0.00000 deg
	In/Out	All	All
BIN 5	UpperLimit	0.00000 Ω	0.00000 deg
OFF	LowerLimit	0.00000 Ω	0.00000 deg

Step 3. Set the measurement parameter for Condition 1 to Ls.

Figure 8-19 Setting the measurement parameter for Condition 1

Table1		Condition1	Condition2
RdcTest:	Stimulus	(3) 100.00 MHz	(1) 1.0000 MHz
UP 10.00 kΩ	Parameter	Ls	θz(deg)
LO 0.000 Ω	Mode	Z	ABS
	Nominal	Y	-----
	UpperLimit	Ls	
BIN 1	UpperLimit	Lp	0.00000 deg
OFF	LowerLimit	Cs	0.00000 deg
	In/Out	Cp	All
BIN 2	UpperLimit	Rs	0.00000 deg
OFF	LowerLimit	Rp	0.00000 deg
	In/Out	Q	All
BIN 3	UpperLimit	D	0.00000 deg
OFF	LowerLimit		0.00000 deg
	In/Out		All
BIN 4	UpperLimit		0.00000 deg
OFF	LowerLimit		0.00000 deg
	In/Out	All	All
BIN 5	UpperLimit		0.00000 deg
OFF	LowerLimit		0.00000 deg

Step 4. Next, use the following procedure to set the setting mode for the range of sorting for Condition 1.

- Click the limit setting mode (Mode) cell in the Condition 1 column to select the cell.
- Click the down-arrow ▼ that appears in the right side of the cell.
- In the drop-down list box that appears, click “PCNT” (percent) (Figure 8-20).

Figure 8-20 Setting the limit setting mode (Mode) for Condition 1

4287A RF LCR Meter			
1.File 2.Edit 3.View 4.Table			
STIMULUS		CAL KIT	COMPEN KIT
COMPARATOR			
Table1		Condition1	Condition2
RdcTest:	Stimulus	(3) 100.00 MHz	(1) 1.0000 MHz
UP 10.00 kΩ	Parameter	Ls	θz(deg)
LO 0.000 Ω	Mode	%	ABS
	Nominal	ABS	-----
BIN 1	UpperLimit	%	0.00000 deg
OFF	LowerLimit	DEV	0.00000 deg
	In/Out	All	All
BIN 2	UpperLimit	0.00000 H	0.00000 deg
OFF	LowerLimit	0.00000 H	0.00000 deg
	In/Out	All	All
BIN 3	UpperLimit	0.00000 H	0.00000 deg
OFF	LowerLimit	0.00000 H	0.00000 deg
	In/Out	All	All
BIN 4	UpperLimit	0.00000 H	0.00000 deg
OFF	LowerLimit	0.00000 H	0.00000 deg
	In/Out	All	All
BIN 5	UpperLimit	0.00000 H	0.00000 deg
OFF	LowerLimit	0.00000 H	0.00000 deg
	In/Out	All	All

4287aoj123

- d. Click the reference value (Nominal) cell below the limit setting mode (Mode) cell.
- e. Press the [5], [0] and [G/n] keys in the entry block on the front panel sequentially to input 50 nH as the reference value.

Figure 8-21 Entering the reference value (Nominal)

4287A RF LCR Meter			
1.File 2.Edit 3.View 4.Table			
STIMULUS		CAL KIT	COMPEN KIT
COMPARATOR			
Table1		Condition1	Condition2
RdcTest:	Stimulus	(3) 100.00 MHz	(1) 1.0000 MHz
UP 10.00 kΩ	Parameter	Ls	θz(deg)
LO 0.000 Ω	Mode	%	ABS
	Nominal	50.0000 nH	-----
BIN 1	UpperLimit	0.000 %	0.00000 deg
OFF	LowerLimit	0.000 %	0.00000 deg
	In/Out	All	All
BIN 2	UpperLimit	0.000 %	0.00000 deg
OFF	LowerLimit	0.000 %	0.00000 deg
	In/Out	All	All
BIN 3	UpperLimit	0.000 %	0.00000 deg
OFF	LowerLimit	0.000 %	0.00000 deg
	In/Out	All	All
BIN 4	UpperLimit	0.000 %	0.00000 deg
OFF	LowerLimit	0.000 %	0.00000 deg
	In/Out	All	All
BIN 5	UpperLimit	0.000 %	0.00000 deg
OFF	LowerLimit	0.000 %	0.00000 deg
	In/Out	All	All

4287aoj124

Setting the measurement point number, measurement parameter, and BIN range setting mode for Condition 2

- Step 1.** In the same manner as for Condition 1, set the measurement point number for Condition 2 by following this procedure.
- Click with the mouse the measurement point number (Stimulus) cell in the Condition 2 column to select the cell.
 - Click the down-arrow ▼ that appears in the right side of the cell.
 - In the drop-down list box that appears, click “(3) 100.00 MHz” (Figure 8-22).

Figure 8-22

Setting the measurement point number (Stimulus) for Condition 2

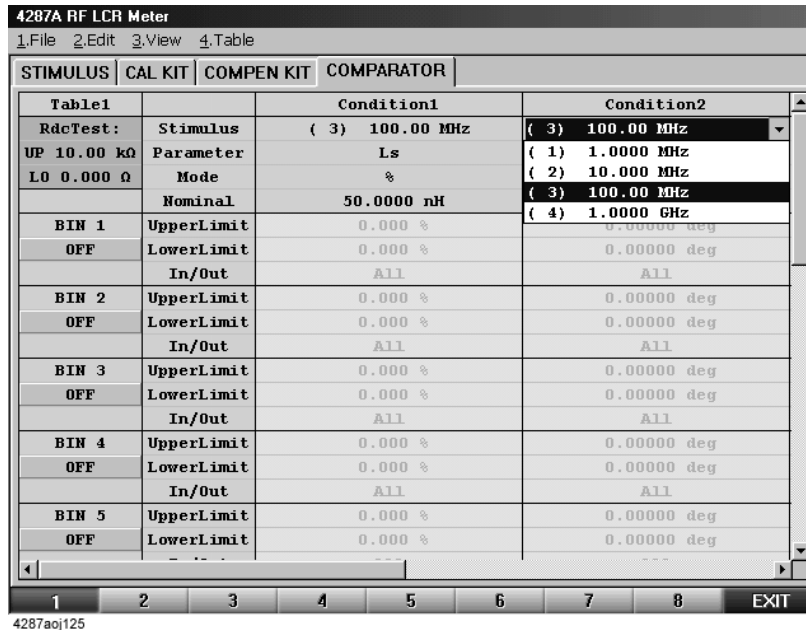

- Step 2.** Set the measurement parameter for Condition 2 as follows.
- Click the measurement parameter (Parameter) cell in the Condition 2 column to select the cell.
 - Click the down-arrow ▼ that appears in the right side of the cell.
 - In the drop-down list box that appears, click “Q” (Figure 8-23).

Figure 8-23

Setting the measurement parameter (Parameter) for Condition 2

Table1	Condition1	Condition2
RdcTest:	(3) 100.00 MHz	(3) 100.00 MHz
UP 10.00 kΩ	Ls	Q
LO 0.000 Ω	%	Z
	Nominal	Y
	50.0000 nH	Ls
BIN 1	UpperLimit	Lp
OFF	LowerLimit	Cs
	In/Out	Cp
BIN 2	UpperLimit	Rs
OFF	LowerLimit	Rp
	In/Out	Q
BIN 3	UpperLimit	D
OFF	LowerLimit	0.00000
	In/Out	0.00000
BIN 4	UpperLimit	All
OFF	LowerLimit	All
	In/Out	All
BIN 5	UpperLimit	0.00000
OFF	LowerLimit	0.00000
	In/Out	0.00000

NOTE

The setting mode for the range for sorting in Condition 2 is not changed from the default setting “ABS” (absolute value setting). When set with an absolute value, the reference value is not required and “-----” is indicated in the “Nominal” cell.

Setting the measurement value range for sorting into BIN 1 to BIN 3

After setting the measurement point number, measurement parameter, and BIN range setting mode for both Condition 1 and Condition 2, set the measurement value range for sorting into BIN 1 to BIN 3.

- Step 1.** Set the upper limit measurement value for sorting into BIN 1 for Condition 1 by following this procedure.
- a. Click with the mouse the BIN 1 UpperLimit cell in the Condition 1 column to select the cell.
 - b. Press the [1] key in the entry block on the front panel (Figure 8-24) and then press the [×1] key to enter + 1% as the upper limit value for BIN 1.

Sorting According to Measurement Results
 Example of Settings for BIN Sorting

Figure 8-24 Setting the upper limit value for Condition 1 of BIN 1

4287A RF LCR Meter			
1.File 2.Edit 3.View 4.Table			
STIMULUS		COMPARATOR	
Table1		Condition1	Condition2
RdcTest:	Stimulus	(3) 100.00 MHz	(3) 100.00 MHz
UP 10.00 kΩ	Parameter	Ls	Q
LO 0.000 Ω	Mode	%	ABS
	Nominal	50.0000 nH	-----
BIN 1	UpperLimit		0.00000
OFF	LowerLimit	-1 %	0.00000
	In/Out	All	All
BIN 2	UpperLimit	0.000 %	0.00000
OFF	LowerLimit	0.000 %	0.00000
	In/Out	All	All
BIN 3	UpperLimit	0.000 %	0.00000
OFF	LowerLimit	0.000 %	0.00000
	In/Out	All	All
BIN 4	UpperLimit	0.000 %	0.00000
OFF	LowerLimit	0.000 %	0.00000
	In/Out	All	All
BIN 5	UpperLimit	0.000 %	0.00000
OFF	LowerLimit	0.000 %	0.00000
	In/Out	All	All

4287a0j127

Step 2. Set the lower limit measurement value for sorting into BIN 1 for Condition 1 by following this procedure.

- a. Click the BIN 1 LowerLimit cell in the Condition 1 column to select the cell.
- b. Press the [-][1] keys in the entry block on the front panel (Figure 8-25) and then press the [×1] key to enter -1% as the lower limit value for BIN 1.

Figure 8-25 Setting the lower limit value for Condition 1 for BIN 1

4287A RF LCR Meter			
1.File 2.Edit 3.View 4.Table			
STIMULUS		COMPARATOR	
Table1		Condition1	Condition2
RdcTest:	Stimulus	(3) 100.00 MHz	(3) 100.00 MHz
UP 10.00 kΩ	Parameter	Ls	Q
LO 0.000 Ω	Mode	%	ABS
	Nominal	50.0000 nH	-----
BIN 1	UpperLimit	1.000 %	0.00000
OFF	LowerLimit	-1 %	0.00000
	In/Out	All	All
BIN 2	UpperLimit	0.000 %	0.00000
OFF	LowerLimit	0.000 %	0.00000
	In/Out	All	All
BIN 3	UpperLimit	0.000 %	0.00000
OFF	LowerLimit	0.000 %	0.00000
	In/Out	All	All
BIN 4	UpperLimit	0.000 %	0.00000
OFF	LowerLimit	0.000 %	0.00000
	In/Out	All	All
BIN 5	UpperLimit	0.000 %	0.00000
OFF	LowerLimit	0.000 %	0.00000
	In/Out	All	All

4287a0j128

Step 3. Set the BIN range mode for sorting into BIN 1 for Condition 1 to “In”.

Figure 8-26

Setting the BIN range mode for sorting into BIN 1 for Condition 1

4287A RF LCR Meter			
1.File 2.Edit 3.View 4.Table			
STIMULUS		COMPARATOR	
Table1		Condition1	Condition2
RdcTest:	Stimulus	(3) 100.00 MHz	(3) 100.00 MHz
UP 10.00 kΩ	Parameter	Ls	Q
LO 0.000 Ω	Mode	%	ABS
	Nominal	50.0000 nH	-----
BIN 1	UpperLimit	1.000 %	0.00000
OFF	LowerLimit	-1.000 %	0.00000
	In/Out	In	All
BIN 2	UpperLimit	In	0.00000
OFF	LowerLimit	Out	0.00000
	In/Out	All	All
BIN 3	UpperLimit	0.000 %	0.00000
OFF	LowerLimit	0.000 %	0.00000
	In/Out	All	All
BIN 4	UpperLimit	0.000 %	0.00000
OFF	LowerLimit	0.000 %	0.00000
	In/Out	All	All
BIN 5	UpperLimit	0.000 %	0.00000
OFF	LowerLimit	0.000 %	0.00000

4287a0j129

- Step 4.** Set the upper limit measurement value for sorting into BIN 1 for Condition 2 by following this procedure.
- Click the BIN 1 UpperLimit cell in the Condition 2 column to select the cell.
 - Press the [1] key in the entry block on the front panel (Figure 8-27) and then press the [G/n] key to enter 1G as the upper limit value for Condition 2 of BIN 1.

Figure 8-27

Setting the upper limit value for Condition 2 of BIN 1

4287A RF LCR Meter			
1.File 2.Edit 3.View 4.Table			
STIMULUS		COMPARATOR	
Table1		Condition1	Condition2
RdcTest:	Stimulus	(3) 100.00 MHz	(3) 100.00 MHz
UP 10.00 kΩ	Parameter	Ls	Q
LO 0.000 Ω	Mode	%	ABS
	Nominal	50.0000 nH	-----
BIN 1	UpperLimit	1.000 %	1
OFF	LowerLimit	-1.000 %	
	In/Out	In	All
BIN 2	UpperLimit	0.000 %	0.00000
OFF	LowerLimit	0.000 %	0.00000
	In/Out	All	All
BIN 3	UpperLimit	0.000 %	0.00000
OFF	LowerLimit	0.000 %	0.00000
	In/Out	All	All
BIN 4	UpperLimit	0.000 %	0.00000
OFF	LowerLimit	0.000 %	0.00000
	In/Out	All	All
BIN 5	UpperLimit	0.000 %	0.00000
OFF	LowerLimit	0.000 %	0.00000

4287a0j130

Sorting According to Measurement Results
Example of Settings for BIN Sorting

NOTE

Instead of setting the upper limit to infinite, 1G is entered as a sufficiently large value.

The In/Out cell is left unchanged in the default setting “In” (the BIN range is between the upper limit and lower limit).

- Step 5.** Set the lower limit measurement value for sorting into BIN 1 for Condition 2 by following this procedure.
- a. Click the BIN 1 LowerLimit cell in the Condition 2 column to select the cell.
 - b. Press the [1][0][0] keys in the entry block on the front panel (Figure 8-28) and then press the [×1] key to enter 100 as the lower limit value for Condition 2 of BIN 1.

Figure 8-28 Setting the lower limit value for Condition 2 of BIN 1

4287A RF LCR Meter				
1.File 2.Edit 3.View 4.Table				
STIMULUS		CAL KIT	COMPEN KIT	COMPARATOR
Table1		Condition1	Condition2	
RdcTest:	Stimulus	(3) 100.00 MHz	(3) 100.00 MHz	
UP 10.00 kΩ	Parameter	Ls	Q	
LO 0.000 Ω	Mode	%	ABS	
	Nominal	50.0000 nH	-----	
BIN 1	UpperLimit	1.000 %	1.00000 G	
OFF	LowerLimit	-1.000 %	100	
	In/Out	In		
BIN 2	UpperLimit	0.000 %	0.00000	
OFF	LowerLimit	0.000 %	0.00000	
	In/Out	All	All	
BIN 3	UpperLimit	0.000 %	0.00000	
OFF	LowerLimit	0.000 %	0.00000	
	In/Out	All	All	
BIN 4	UpperLimit	0.000 %	0.00000	
OFF	LowerLimit	0.000 %	0.00000	
	In/Out	All	All	
BIN 5	UpperLimit	0.000 %	0.00000	
OFF	LowerLimit	0.000 %	0.00000	
	In/Out	All	All	

4287aaj131

- Step 6.** Set the BIN range mode of Condition 2 for sorting into BIN 1 to “In”.

Figure 8-29

Setting the BIN range mode of Condition 2 of BIN 2

The screenshot shows the 'COMPARATOR' tab of the 4287A RF LCR Meter. The main table displays settings for five bins. For BIN 2, the 'In/Out' dropdown menu is open, showing options: In, Out, and All. The current selection is 'In'.

Table1		Condition1	Condition2
RdcTest:	Stimulus	(3) 100.00 MHz	(3) 100.00 MHz
UP 10.00 kΩ	Parameter	Ls	Q
LO 0.000 Ω	Mode	%	ABS
	Nominal	50.0000 nH	-----
BIN 1	UpperLimit	1.000 %	1.00000 G
OFF	LowerLimit	-1.000 %	100.000
	In/Out	In	In
BIN 2	UpperLimit	0.000 %	0.00000
OFF	LowerLimit	0.000 %	0.00000
	In/Out	All	All
BIN 3	UpperLimit	0.000 %	0.00000
OFF	LowerLimit	0.000 %	0.00000
	In/Out	All	All
BIN 4	UpperLimit	0.000 %	0.00000
OFF	LowerLimit	0.000 %	0.00000
	In/Out	All	All
BIN 5	UpperLimit	0.000 %	0.00000
OFF	LowerLimit	0.000 %	0.00000

Step 7. Set the BIN 1 setting to On.

Figure 8-30

BIN 1 turned to ON setting

The screenshot shows the 'COMPARATOR' tab of the 4287A RF LCR Meter. The 'BIN 1' setting is now 'ON'. The 'In/Out' dropdown menu is still open, showing 'In' selected.

Table1		Condition1	Condition2
RdcTest:	Stimulus	(3) 100.00 MHz	(3) 100.00 MHz
UP 10.00 kΩ	Parameter	Ls	Q
LO 0.000 Ω	Mode	%	ABS
	Nominal	50.0000 nH	-----
BIN 1	UpperLimit	1.000 %	1.00000 G
ON	LowerLimit	-1.000 %	100.000
	In/Out	In	In
BIN 2	UpperLimit	0.000 %	0.00000
OFF	LowerLimit	0.000 %	0.00000
	In/Out	All	All
BIN 3	UpperLimit	0.000 %	0.00000
OFF	LowerLimit	0.000 %	0.00000
	In/Out	All	All
BIN 4	UpperLimit	0.000 %	0.00000
OFF	LowerLimit	0.000 %	0.00000
	In/Out	All	All
BIN 5	UpperLimit	0.000 %	0.00000
OFF	LowerLimit	0.000 %	0.00000

Step 8. In the same manner as for BIN 1, set the measurement value ranges for BIN 2 and BIN 3 as shown in Figure 8-31.

Sorting According to Measurement Results
 Example of Settings for BIN Sorting

Figure 8-31

BIN 2 and BIN 3 sorting condition settings

The screenshot shows the 'Table1' window of the 4287A RF LCR Meter. The window title is '4287A RF LCR Meter' and it has a menu bar with '1.File', '2.Edit', '3.View', and '4.Table'. Below the menu bar are four tabs: 'STIMULUS', 'CAL KIT', 'COMPEN KIT', and 'COMPARATOR'. The main area is a table with columns for 'Table1', 'Stimulus', 'Condition1', and 'Condition2'. The table contains settings for five bins (BIN 1 to BIN 5). BIN 1 is set to 'ON' with upper and lower limits of 1.000% and -1.000% respectively, and an 'In/Out' setting of 'In'. BIN 2 is set to 'ON' with upper and lower limits of 2.000% and -2.000% respectively, and an 'In/Out' setting of 'In'. BIN 3 is set to 'ON' with upper and lower limits of 2.000% and -2.000% respectively, and an 'In/Out' setting of 'In'. BIN 4 is set to 'OFF' with upper and lower limits of 0.000% and 0.000% respectively, and an 'In/Out' setting of 'All'. BIN 5 is set to 'OFF' with upper and lower limits of 0.000% and 0.000% respectively, and an 'In/Out' setting of 'All'. The table also shows stimulus parameters: RdcTest: UP 10.00 kΩ, LO 0.000 Ω; Stimulus Parameter: Mode; and Nominal: 50.0000 nH. Condition1 and Condition2 are both set to (3) 100.00 MHz, with parameters Ls and Q respectively, and a mode of ABS. The bottom of the window has a status bar with buttons 1 through 8 and an 'EXIT' button. The text '4287aaj134' is visible at the bottom left of the screenshot.

Table1	Stimulus	Condition1	Condition2
RdcTest:	UP 10.00 kΩ	(3) 100.00 MHz	(3) 100.00 MHz
LO 0.000 Ω	Parameter	Ls	Q
	Mode	%	ABS
	Nominal	50.0000 nH	-----
BIN 1	UpperLimit	1.000 %	1.00000 G
ON	LowerLimit	-1.000 %	100.000
	In/Out	In	In
BIN 2	UpperLimit	2.000 %	1.00000 G
ON	LowerLimit	-2.000 %	100.000
	In/Out	In	In
BIN 3	UpperLimit	2.000 %	100.000
ON	LowerLimit	-2.000 %	-1.00000 G
	In/Out	In	In
BIN 4	UpperLimit	0.000 %	0.00000
OFF	LowerLimit	0.000 %	0.00000
	In/Out	All	All
BIN 5	UpperLimit	0.000 %	0.00000
OFF	LowerLimit	0.000 %	0.00000

OUT OF GOOD BINS setting

Following these steps to set OUT OF GOOD BINS.

- Step 1.** Click with the mouse “2. Edit” in the menu bar to display the pull-down menu.
- Step 2.** Click “7. Out Of Good Bins ►” in the pull-down menu (selection sub-menu appears to the right).
- Step 3.** Click “Out Of Good Bins: >Bin3” (Figure 8-32).

Figure 8-32

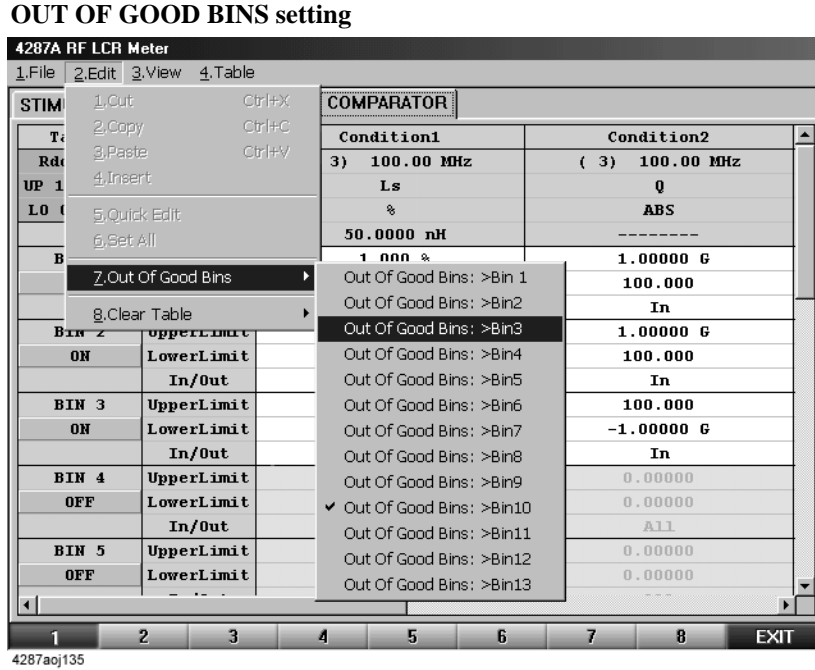

The GOOD BINS line is drawn between BIN 3 and BIN 4 as shown in Figure 8-33. In accordance with this setting, measurement results that do not meet the conditions set for BIN 1 to BIN 3 are judged to be OUT OF GOOD BINS.

Figure 8-33

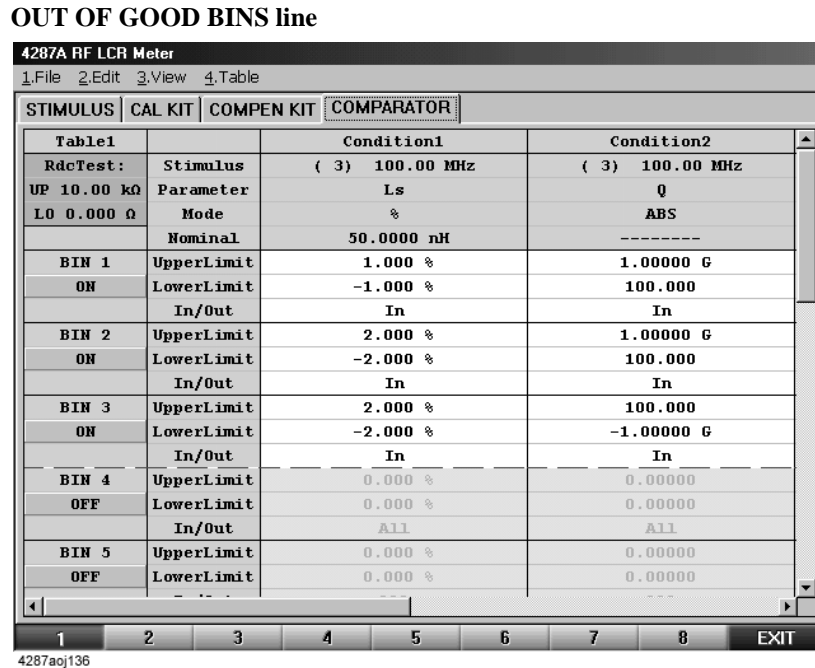

8. Sorting According to Measurement Results

Sorting According to Measurement Results

Example of Settings for BIN Sorting

Displaying the BIN sorting results

Following these steps to display the BIN sort result on the LCD display.

- Step 1.** Press the **[System]** key on the front panel to display the System softkey menu.
- Step 2.** Press the **Comparator []** softkey to turn on the comparator function. The BIN sort result is displayed for each measurement in the upper left part of the LCD display (Figure 8-34).

Figure 8-34

BIN sorting result display

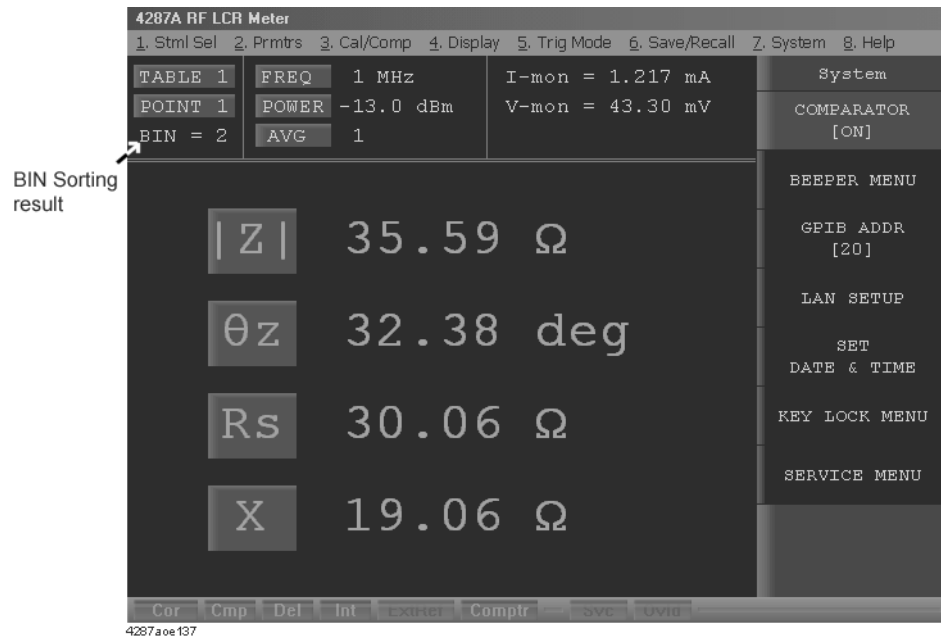

9

Obtaining Statistical Data on Measurement Results

This chapter describes the functions for calculating and displaying statistical data following continuous recording of measurement results.

Overview of Functions for Statistical Analysis

Agilent 4287A's functions for statistical analysis allow you to store the required values of measurement results (four measurement parameters, test signal voltage level monitor value, test signal current level monitor value, DC resistance measurement value) in the order of measurement internally in the unit. These functions also allow you to calculate and display statistical data based on the stored data.

The parameter names and definitions of the statistical data that can be calculated and displayed are shown in Table 9-1.

Table 9-1 Statistical analysis parameters of 4287A

Parameter name	Definition
Mean value (Mean)	$\frac{\sum_{i=1}^n x_i}{n}$ (n = number of normal measurements, x_i = normal measurement number i)
Standard Deviation (SD)	$\sqrt{\frac{\sum_{i=1}^n (x_i - Mean)^2}{n - 1}}$ (n = number of normal measurements, x_i = normal measurement number i)
3*SD/Mean	$\frac{3 \times SD}{Mean}$
Minimum value (Min)	Smallest measured value among normal measurements *1
Maximum value (Max)	Largest measured value among normal measurements
Number of normal measurements (Total = n)	Number of measurements performed normally
Number of Rdc limit deviations (Rdc Fail)	Number of measurements where Rdc measurement value deviated from the limit value
Number of overloads (Ovld)	Number of measurements where overloaded occurred
Number of abnormal measurements (Abnorm.)	Number of measurements where either Rdc limit deviation or overload occurred
Total number of measurements (All)	The total number of measurements (including abnormal measurements)

*1. Measurements where neither Rdc limit deviation nor overload occur.

Data Logging for Statistical Analysis

Perform the following steps to log the data to be used in statistical analysis.

- Step 1.** From the seven parameters (measurement parameter 1, measurement parameter 2, measurement parameter 3, measurement parameter 4, test signal voltage level monitor value (I-mon), test signal current level monitor value (V-mon), and DC resistance measurement value (Rdc)), select the parameters for statistical analysis and display them on the single point measurement display or on the list measurement display.

NOTE

Parameters displayed on the measurement display are subjected to statistical analysis. Accordingly, make sure that parameters that should not be subjected to statistical analysis are not displayed on the measurement display. For how to turn the parameter display off, see Chapter 7, “Executing Measurements and Displaying Results,” on page 155.

When measuring with multiple measurement points on the list measurement display, each of the measurement points are subjected to statistical analysis.

- Step 2.** Press the **[Trig Mode]** key on the instrument state block of the front panel to display the trigger mode softkey menu.

- Step 3.** Select **DATA LOGGING** from the softkey menu to display the DATA LOGGING softkey menu.

Select **MAX LOG SIZE []** from the softkey menu to display the Data Logging Size input window (Figure 9-1).

Figure 9-1

Data Logging Size input window



- Step 4.** Enter the data logging size by clicking the number keys in the window. When done, click the **Enter** key to complete the input.

NOTE

A single data logging size is required for all parameters in the same measurement. For example, if seven parameters are displayed in the single point measurement display and list measurement with four measuring points are to be performed with 1000 data logged for each point, it is necessary to set the data logging size to $7 \times 4 \times 1,000 = 28,000$.

The data logging size can be set to a maximum of 2,400,000 (points).

- Step 5.** Select **START LOGGING** from the DATA LOGGING softkey menu to start data logging.

Obtaining Statistical Data on Measurement Results
Data Logging for Statistical Analysis

Step 6. Activate the measurement trigger and execute measurement the required number of times.

NOTE

When the trigger mode is free run, data logging starts at the time the **START LOGGING** key is selected in Step 6.

Executing Statistical Analysis and Displaying Results

The following procedure is used to execute statistical analysis and display results.

- Step 1.** Press the **[Prmtr]** key on the measurement block of the front panel to display the Prmtrs softkey menu.
- Step 2.** Select the **DATA EXAM** softkey to display the DATA EXAM softkey menu.
- Step 3.** From the softkey menu, select the parameters to be subjected to statistical analysis and show the results of the statistical analysis of the parameters on the display.

Figure 9-2 Results of statistical analysis

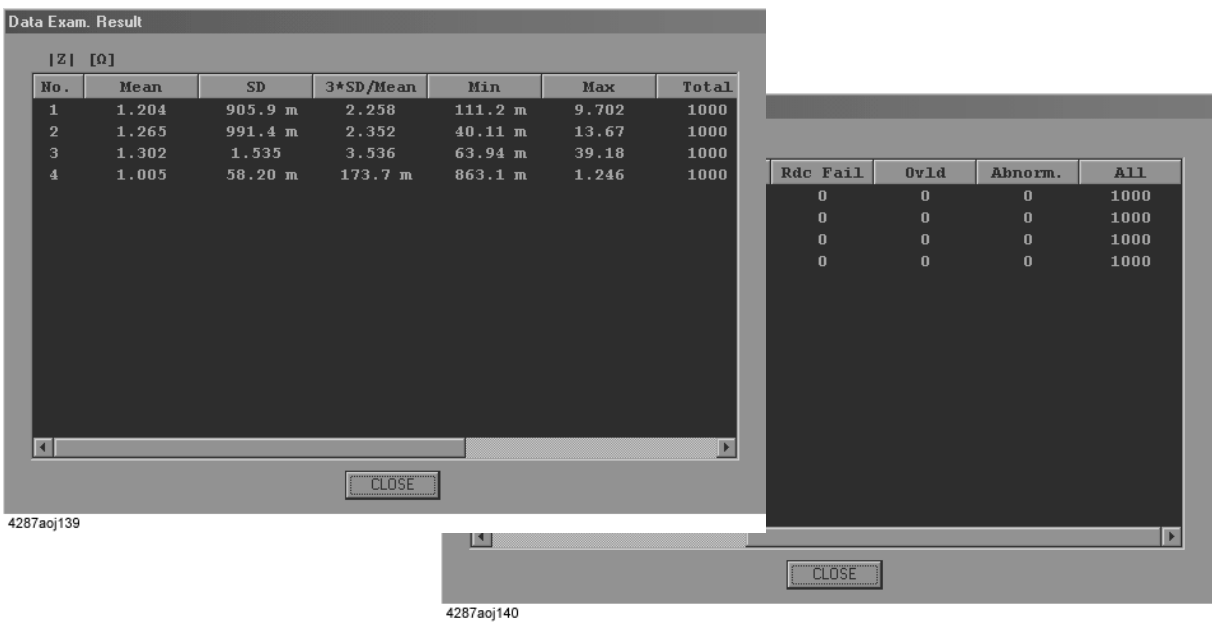

NOTE

For the definition of each of the statistical analysis parameters, see “Overview of Functions for Statistical Analysis” on page 206.

Saving Measurement Data for Statistical Analysis

The following procedure can be used to save measurement data for statistical analysis to the 4287A's hard disk or to a floppy disk.

- Step 1.** Press the **[Save/Recall]** key on the instrument state block of the front panel to display the Save/Recall softkey menu.
- Step 2.** Press either of the following softkeys to display the window for saving measurement data for the statistical analysis.

Softkey	Function
EXPORT LOG (ASC)	Displays the window for saving measurement data for the statistical analysis in ASCII format.
EXPORT LOG DATA (BIN)	Displays the window for saving measurement data for the statistical analysis in binary format.

Figure 9-3 Windows for saving results of statistical analysis (left: ASCII format; right: Binary format)

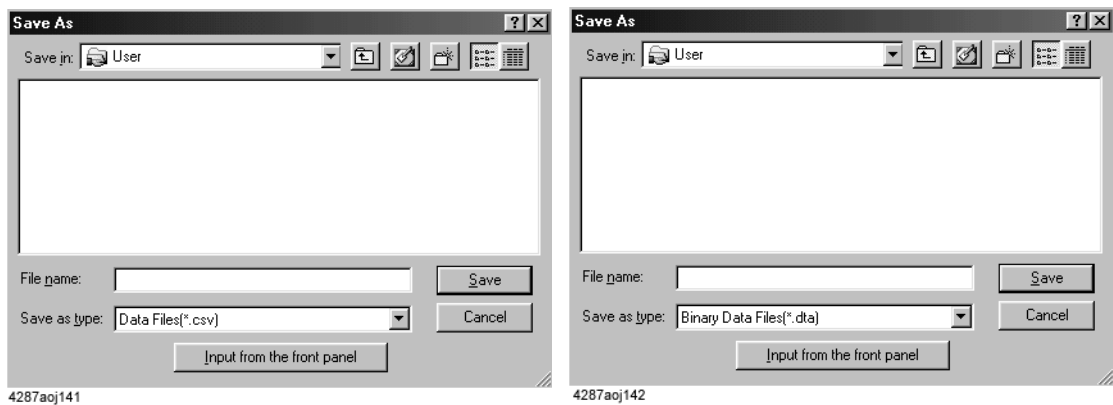

- Step 3.** Enter the filename in the File name box.

NOTE

The user is not required to add the extension following the filename (the “.csv” filename extension is automatically added).

When using the mouse to enter the filename, follow this procedure.

- Click the **Input from the front panel** key to display the File Name input window (Figure 9-4).

Figure 9-4 File Name input window



- b. Click the letter keys to enter the filename.
- c. Click the **Enter** key to complete the filename input.

Key	Function
(Letter and symbol keys)	To enter the alphabetic letter or symbol shown on the key face at the position of the cursor on the input line.
ABC	To switch the letter and symbol keys to the upper case mode.
abc	To switch the letter and symbol keys to the lower case mode.
!@#\$%	To switch the letter and symbol keys to the symbol mode.
<-	To move the cursor on the input line one character to the left.
->	To move the cursor on the input line one character to the right.
Del	To delete the character to the right of the cursor.
BS	To delete the character to the left of the cursor.
Cancel	To cancel the input of the filename in the File Name input window and close the window.
Enter	To accept the character string entered on the input line as the filename and close the window.

Step 4. Press the **Save** key to save the results of the statistical analysis in a file with the specified file name and in the specified file format.

Obtaining Statistical Data on Measurement Results
Saving Measurement Data for Statistical Analysis

10

Storing and Retrieving 4287A Internal Information and File Management

This chapter describes the methods used for storing and retrieving 4287A internal information (setting statuses, results of statistical analyses, screen displays) as well as file management.

Saving Setting Status

The following procedure can be used to save any of several setting statuses of the 4287A on a storage device (built-in nonvolatile memory or floppy disk).

- Step 1.** Set the 4287A to the setting status that you want to record.
- Step 2.** Press the **[Save/Recall]** key on the instrument state block of the front panel to display the Save/Recall softkey menu.
- Step 3.** Press the **SAVE STATE** softkey to display the dialog box for saving the setting status.

Figure 10-1 Save As dialog box for saving setting status

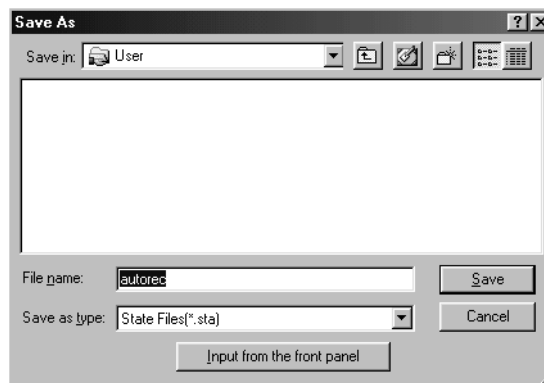

- Step 4.** Enter the filename in the File name box. If you want to enter the filename using the mouse, see “Entering the Filename using the Mouse” on page 215.

NOTE The user is not required to add the extension following the filename (the “.sta” filename extension is automatically added).

NOTE If the filename is specified as “autorec,” the 4287A will automatically retrieve the corresponding settings at the time the power is turned on. This “autorec” file can also be automatically created at the time of calibration and compensation. For details, see the explanation in Chapter 6, “Calibration and Compensation,” on page 115.

- Step 5.** Press the **Save** key to save the setting status with the specified file name.

Entering the Filename using the Mouse

When using the mouse for entering the filename, follow this procedure.

- Step 1.** Click the **Input from the front panel** button to display the file name input window (Figure 10-2).

Figure 10-2

File Name input window



- Step 2.** Click the letter keys to enter the filename.

- Step 3.** Click the **Enter** key to complete the filename input.

Key	Function
(Letter and symbol keys)	To enter the alphabetic letter or symbol shown on the key face at the position of the cursor on the input line.
ABC	To switch the letter and symbol keys to the upper case mode.
abc	To switch the letter and symbol keys to the lower case mode.
!@#\$%	To switch the letter and symbol keys to the symbol mode.
<-	To move the cursor on the input line one character to the left.
->	To move the cursor on the input line one character to the right.
Del	To delete the character to the right of the cursor.
BS	To delete the character to the left of the cursor.
Cancel	To cancel the input of the filename in the File Name input window and close the window.
Enter	To accept the character string entered on the input line as the filename and close the window.

Saving Screen Displays

Follow this procedure to save the 4287A's current screen display on a storage device (built-in nonvolatile memory or floppy disk) in the Windows bitmap format (.bmp).

- Step 1.** Set the 4287A to show the screen display that you want to record.
- Step 2.** Press the **[Capture]** key (same as **[Display]** key) on the instrument state block of the front panel to temporarily store the screen display in the internal memory.

NOTE

When the Capture key is pressed, the Display softkey menu appears and the displayed screen is simultaneously stored in the internal memory.

- Step 3.** Press the **[Save/Recall]** key on the instrument state block of the front panel to display the Save/Recall softkey menu.
- Step 4.** Press the **SAVE GRAPHIC** softkey to display the Save As dialog box for saving the screen display.

Figure 10-3

Save As dialog box for saving screen display

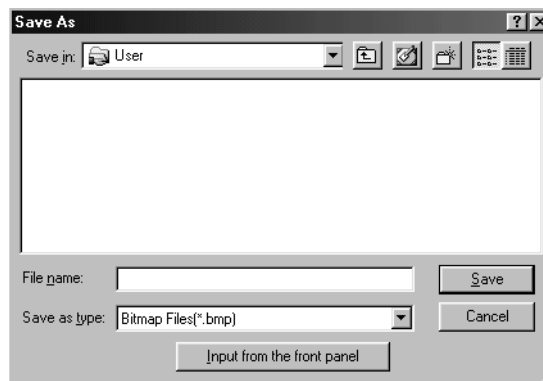

- Step 5.** Enter the filename in the File name box. If you want to enter the filename using the mouse, see “Entering the Filename using the Mouse” on page 215.

NOTE

The user is not required to add the extension following the filename (the “.bmp” filename extension is automatically added).

NOTE

The size of the screen's image file is sometimes above 720 kB and cannot be save onto a 2DD (720 kB) floppy disk. When you try to save the image, the system indicates “save error” and the image will not be stored. In this case, use a 2HD (1.44 MB) disk to save the image.

- Step 6.** Press the **Save** key to save the temporarily stored screen display.

Saving the List Measurement Display in CSV Format

The following procedure can be used to save the setting values and measurement result list components of the list measurement display of the 4287A on a storage device (built-in nonvolatile memory or floppy disk) in the CSV format (.csv).

- Step 1.** Set the 4287A to show the list measurement display that you want to record.
- Step 2.** Press the **[Save/Recall]** key on the instrument state block of the front panel to display the Save/Recall softkey menu.
- Step 3.** Press the **EXPORT LIST VIEW** softkey to display the Save As window for saving the list measurement display.

Figure 10-4

Save As window for saving the list measurement display

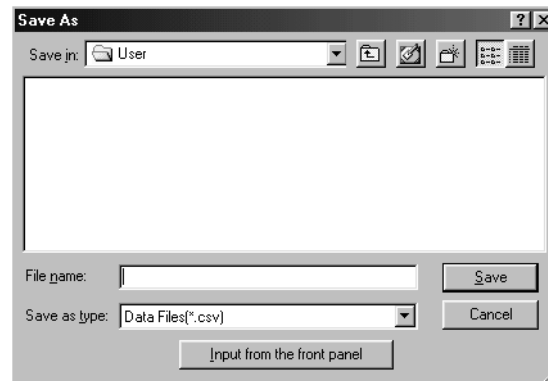

- Step 4.** Enter the filename in the File name box. If you want to enter the filename using the mouse, see “Entering the Filename using the Mouse” on page 215.

NOTE

The user is not required to add the extension following the filename (the “.csv” filename extension is automatically added).

- Step 5.** Press the **Save** key to save the list measurement display.

Example of the Saved List Measurement Display Data (CSV format)

The saved CSV-format data is a text file. This file can be opened using a text editor in a PC(Personal Computer). Table 10-1 shows an example of the list measurement display data in CSV-format.

Table 10-1 List Measurement Display Data in CSV-format (a part of the Table 1)

[Table No.1]												
,,,Cal Kit,,,,,Compen Kit												
,,,Open,,Short,,Load,,Open,,Short												
Freq [Hz],Ave,OSC [dBm],G [S],C [F],R [Ohm],L [H],Rs [Ohm],Ls [H],G [S],C [F],R [Ohm],L [H]												
1E+006,1,-13,0,8.2E-014,0,0,50,0,0,0,0,0												
,,,R_DC,,,Offset Delay,,,R_DC												
,,,Open:G [S],0,,Open [sec],0,,Open:G [S],0												
,,,Short:R [Ohm],0,,Short [sec],0,,Short:R [Ohm],0												
,,,Load:R [Ohm],50,,Load [sec],0												

The CSV-format data can be displayed with a formatted style in a spreadsheet application software. Figure 10-5 shows the CSV data (Table 10-1) displayed in Microsoft Excel.

Figure 10-5 Display the CSV-format List Measurement Display Data in the spreadsheet

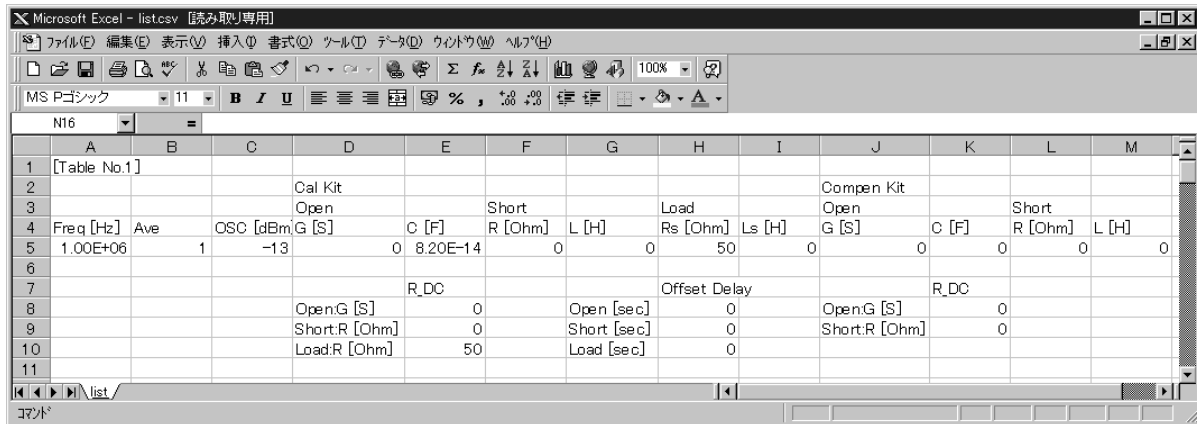

Saving the Setup Table (Measurement point, Calibration kit, Compensation kit) in CSV Format

The following procedure can be used to save the setting values and measurement result list components of the measurement point setup table, calibration kit setup table and compensation kit setup table of the 4287A on a storage device (built-in nonvolatile memory or floppy disk) in the CSV format (.csv).

- Step 1.** Set the 4287A to show the setup table that you want to record.
- Step 2.** Click with the mouse “1.File” in the setup display menu bar to display the pull-down menu.
- Step 3.** Click “1.Export...” in the pull-down menu to display the setup table save as window.

Figure 10-6

Save As window for saving the setup table

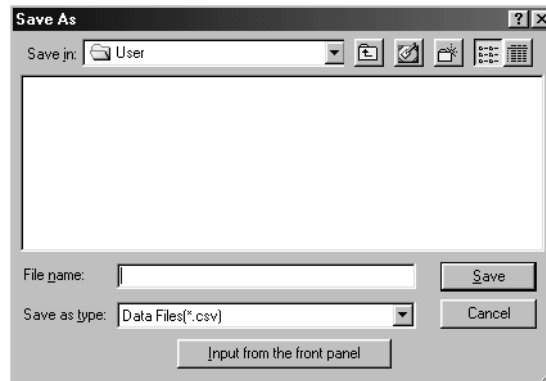

- Step 4.** Enter the filename in the File name box. If you want to enter the filename using the mouse, see “Entering the Filename using the Mouse” on page 215.

NOTE

The user is not required to add the extension following the filename (the “.csv” filename extension is automatically added).

- Step 5.** Press the **Save** key to save the setup table.

Storing and Retrieving 4287A Internal Information and File Management
Saving the Setup Table (Measurement point, Calibration kit, Compensation kit) in CSV Format

Example of the Saved Setup Table Data (CSV format)

The saved CSV-format data is a text file. This file can be opened using a text editor in a PC(Personal Computer). Table 10-2 shows an example of the setup table data in CSV-format.

Table 10-2 Setup Table Data in CSV-format (a part of the Table 1 and 2)

```
[Table No.1]
,,Cal Kit,,,,,Compen Kit
,,Open,,Short,,Load,,Open,,Short
Freq [Hz],Ave,OSC [dBm],G [S],C [F],R [Ohm],L [H],Rs [Ohm],Ls [H],G [S],C [F],R [Ohm],L [H]
1E+006,1,-13,0,8.2E-014,0,0,50,0,0,0,0,0
1E+007,1,-13,0,8.2E-014,0,0,50,0,0,0,0,0
1E+008,1,-13,0,8.2E-014,0,0,50,0,0,0,0,0
1E+009,1,-13,0,8.2E-014,0,0,50,0,0,0,0,0
3E+009,1,-13,0,8.2E-014,0,0,50,0,0,0,0,0

,,,R_DC,,,Offset Delay,,,R_DC
,,Open:G [S],0,,Open [sec],0,,Open:G [S],0
,,Short:R [Ohm],0,,Short [sec],0,,Short:R [Ohm],0
,,Load:R [Ohm],50,,Load [sec],0

[Table No.2]
,,Cal Kit,,,,,Compen Kit
```

The CSV-format data can be displayed with a formatted style in a spreadsheet application software. Figure 10-7 shows the CSV data (Table 10-2) displayed in Microsoft Excel.

Figure 10-7 Display the CSV-format Setup Table Data in the spreadsheet

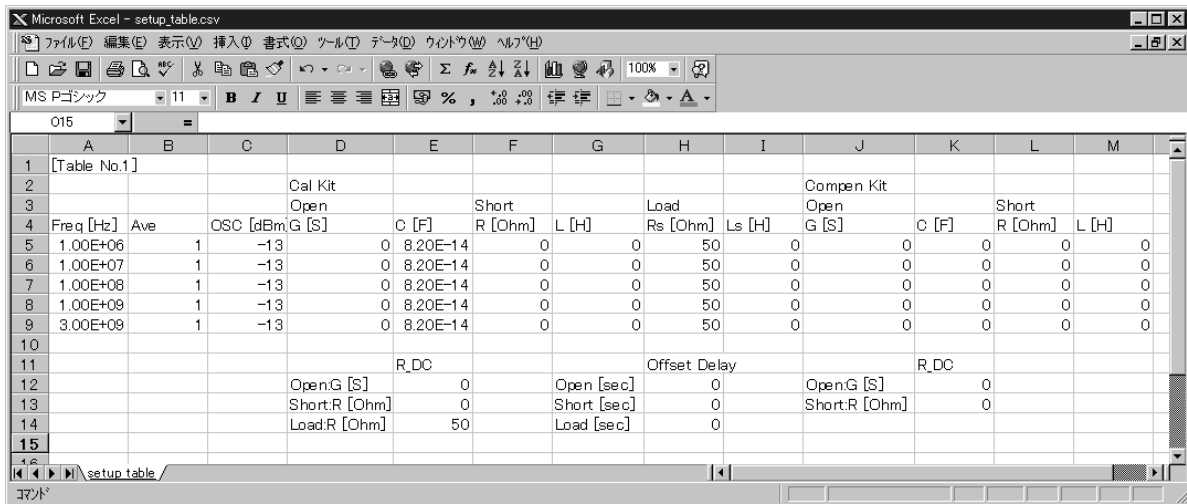

Saving the BIN Sorting Setup Table in CSV Format

The following procedure can be used to save the setting values and measurement result list components of the BIN sorting setup table of the 4287A on a storage device (built-in nonvolatile memory or floppy disk) in the CSV format (.csv).

- Step 1.** Set the 4287A to show the BIN sorting setup display that you want to record.
- Step 2.** Click with the mouse “1.File” in the setup display menu bar to display the pull-down menu.
- Step 3.** Click “1.Export...” in the pull-down menu to display the setup table save as window.

Figure 10-8

Save As window for saving the BIN sorting setup table

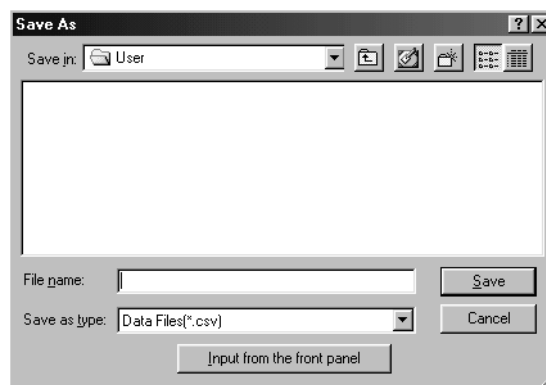

- Step 4.** Enter the filename in the File name box. If you want to enter the filename using the mouse, see “Entering the Filename using the Mouse” on page 215.

NOTE

The user is not required to add the extension following the filename (the “.csv” filename extension is automatically added).

- Step 5.** Press the **Save** key to save the BIN sorting setup table.

Example of the Saved BIN Sorting Setup Table Data (CSV format)

The saved CSV-format data is a text file. This file can be opened using a text editor in a PC(Personal Computer). Table 10-3 shows an example of the setup table data in CSV-format.

Table 10-3 BIN Sorting Setup Table Data in CSV-format (a part of the Table 1)

Table1,,Condition1,Condition2,Condition3,Conditon4
RdcTest:,StimulusNo,2,2,0,0
10000,ParamNo,Ls,Q,Rs,X
0,Mode,%,ABS,ABS,ABS
,Nominal,5e-008,-----,-----,-----
BIN1,UpperLimit,1,1e+009,0,0
ON,LowerLimit,-1,100,0,0
,InOut,In,In,All,All
BIN2,UpperLimit,2,1e+009,0,0
ON,LowerLimit,-2,100,0,0
,InOut,In,In,All,All
BIN3,UpperLimit,2,100,0,0
ON,LowerLimit,-2,-1e+009,0,0
,InOut,In,In,All,All
BIN4,UpperLimit,0,0,0,0
OFF,LowerLimit,0,0,0,0
,InOut,All,All,All,All

The CSV-format data can be displayed with a formatted style in a spreadsheet application software. Figure 10-9 shows the CSV data (Table 10-3) displayed in Microsoft Excel.

Figure 10-9 Display the CSV-format BIN Sorting Setup Table Data in the spreadsheet

	A	B	C	D	E	F	G	H
1	Table1		Condition1	Condition2	Condition3	Condition4		
2	RdcTest:	StimulusNo	2	2	0	0		
3	10000	ParamNo	LS	Q	Rs	X		
4	0	Mode	%	ABS	ABS	ABS		
5		Nominal	5.00E-08	-----	-----	-----		
6	BIN1	UpperLimit	1	1.00E+09	0	0		
7	ON	LowerLimit	-1	100	0	0		
8		InOut	In	In	All	All		
9	BIN2	UpperLimit	2	1.00E+09	0	0		
10	ON	LowerLimit	-2	100	0	0		
11		InOut	In	In	All	All		
12	BIN3	UpperLimit	2	100	0	0		
13	ON	LowerLimit	-2	-1.00E+09	0	0		
14		InOut	In	In	All	All		
15	BIN4	UpperLimit	0	0	0	0		
16	OFF	LowerLimit	0	0	0	0		
17		InOut	All	All	All	All		
18	BIN5	UpperLimit	0	0	0	0		
19	OFF	LowerLimit	0	0	0	0		
20		InOut	All	All	All	All		
21	BIN6	UpperLimit	0	0	0	0		
22	OFF	LowerLimit	0	0	0	0		
23		InOut	All	All	All	All		
24	BIN7	UpperLimit	0	0	0	0		
25	OFF	LowerLimit	0	0	0	0		
26		InOut	All	All	All	All		
27	BIN8	UpperLimit	0	0	0	0		
28	OFF	LowerLimit	0	0	0	0		
29		InOut	All	All	All	All		
30	BIN9	UpperLimit	0	0	0	0		
31	OFF	LowerLimit	0	0	0	0		
32		InOut	All	All	All	All		
33	BIN10	UpperLimit	0	0	0	0		
34	OFF	LowerLimit	0	0	0	0		
35		InOut	All	All	All	All		
36	BIN11	UpperLimit	0	0	0	0		
37	OFF	LowerLimit	0	0	0	0		
38		InOut	All	All	All	All		
39	BIN12	UpperLimit	0	0	0	0		
40	OFF	LowerLimit	0	0	0	0		
41		InOut	All	All	All	All		
42	BIN13	UpperLimit	0	0	0	0		
43	OFF	LowerLimit	0	0	0	0		
44		InOut	All	All	All	All		
45	OutOfGood		3					
46								

11 **Setting and Using the Control and Management Facilities**

This chapter describes the methods for setting and using the control and management facilities for the 4287A functions not directly related to measurement results and analysis.

Checking and Editing the GPIB Address

The 4287A can be controlled by an external controller through the GPIB (General Purpose Interface Bus) interface. The following procedure is used for checking and editing the GPIB address.

NOTE

For how to perform the instruction “press the key (softkey) in the softkey menu” mentioned in the procedure, see “13. Softkeys” on page 87.

Step 1. Press the **[System]** key on the front panel to display the System softkey menu.
 The currently set GPIB address (number) is displayed inside the brackets **[]** in the **GPIB ADDR []** softkey label.







To edit the GPIB address, continue with the following operations.

Step 2. Press the **GPIB ADDR []** key in the softkey menu to display the GPIB ADDRESS dialog box (Figure 11-1).

Figure 11-1 GPIB ADDRESS dialog box





Step 3. Perform the following operations to enter the new GPIB address in the address box of the GPIB ADDRESS dialog box.

Function	Operation		
	Front panel	Keyboard	Mouse
Entering digit at the position of the cursor	Press [0][1][2] ... [9] .	Press [0][1][2] ... [9] .	Click the number keys displayed in the dialog box.
Increasing or lowering the address (numeric value) in the dialog box	Turn  , or press  or  .	Press [↑][↓] .	Click  or  at the right side of the dialog box.
Moving the cursor	Press  or  .	Press [←][→] .	Click the position where the cursor should be moved to.
Deleting the character to the left of the cursor ^{*1}	Press [Back Space] .	Press [←Backspace] .	Click the BS button in the dialog box.
Deleting the character to the right of the cursor ^{*1}	(Not possible)	Press [Delete] .	(Not possible)

*1. If the cursor has been used to select one or more digits, only the selected digits are deleted.

NOTE The GPIB address can be set using whole numbers from 0 to 30.

Step 4. Perform the following operations to complete or cancel the input of the GPIB address.

Function	Operation		
	Front panel	Keyboard	Mouse
To accept the input (execute)	Press [×1],  , or  .	Press [Enter].	Click the Enter button in the dialog box.
To cancel the input	Press [Cancel].* ¹	Press [Esc].	Click the Cancel button in the dialog box.

*1. Same as the [**Alt**] key.

Configuring the Network

NOTE

When you use the 4287A by connecting it to your LAN, consult your network administrator and make the setting of the LAN correctly.

This section describes how to set the following basic items necessary to connect the 4287A to the LAN (Local Area Network).

- “Enabling/disabling network” on page 228
- “Setting IP address” on page 229
- “Specifying computer name” on page 231

If you need detail network settings, consult your network administrator and perform operation in the same way as the Windows 2000® PC.

Enabling/disabling network

You can enable/disable the network connection function of the 4287A.

Follow these steps to enable/disable the network connection function.

- Step 1.** Use the LAN cable to connect the 4287A to the LAN.
- Step 2.** Press **System**.
- Step 3.** Press **LAN Setup**.
- Step 4.** Press **Network Configuration** to open the Network and Dial-up Connections window (Figure 11-2). Press OK in the warning dialog box.

Figure 11-2 Network and Dial-up Connections window

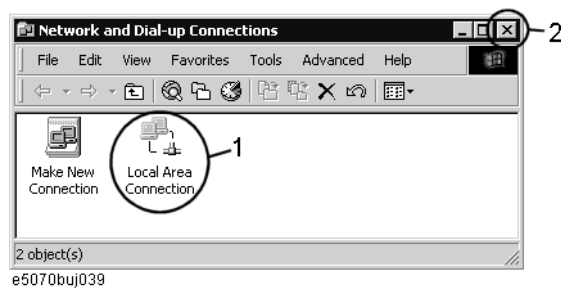

Step 5. When switching from disable to enable:

Double-click the Local Area Connection icon (1 in Figure 11-2) in the Network and Dial-up connections window to enable the network connection function.

Step 6. Click the × button (2 in Figure 11-2) in the upper right of the Network and Dial-up Connections window.

Setting IP address

Follow these steps to set the IP address:

Step 1. Press **System**.

Step 2. Press **LAN Setup**.

Step 3. Press **Network Configuration**.

Step 4. Double-click the Local Area Connection icon (1 in Figure 11-2) in the Network and Dial-up Connections window. The Local Area Connection Status dialog box appears.

Setting and Using the Control and Management Facilities

Configuring the Network

Step 5. The Local Area Connection Properties dialog box (Figure 11-3) appears. Select (highlight) **Internet Protocol (TCP/IP)** (1 in Figure 11-3) and then click the **Properties** button (2 in Figure 11-3).

Figure 11-3 Local Area Connection Properties dialog box

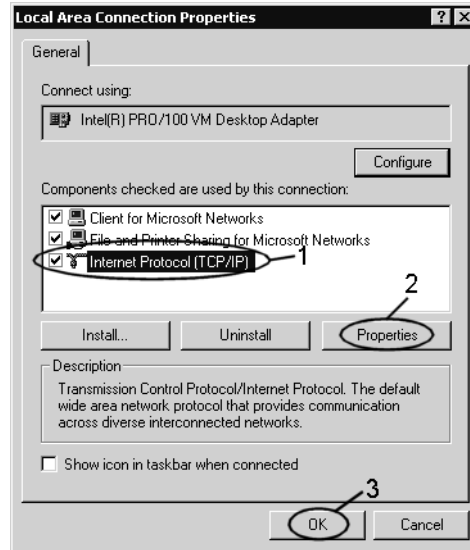

Step 6. The Internet Protocol (TCP/IP) Properties dialog box (Figure 11-4) appears. Click (select) **Use the following IP address** (1 in Figure 11-4) and then enter the IP address (2 in Figure 11-4), the subnet mask (3 in Figure 11-4), and the gateway address (4 in Figure 11-4).

If the IP address can be obtained automatically (if the DHCP server can be used), click (select) **Obtain an IP address automatically** (5 in Figure 11-4).

Figure 11-4 Internet Protocol (TCP/IP) Properties dialog box

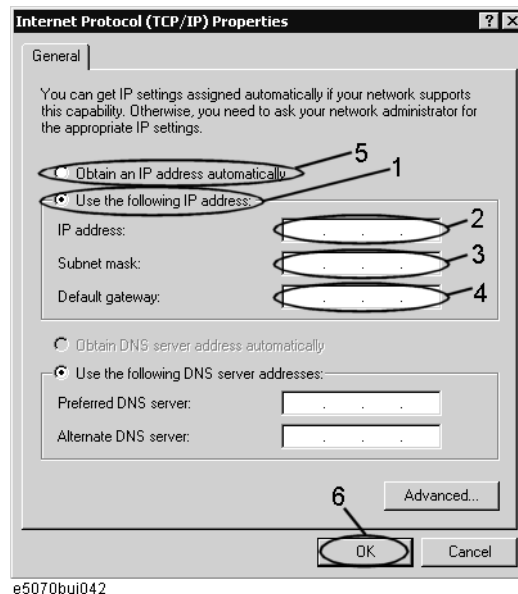

- Step 7.** In the Internet Protocol (TCP/IP) Properties dialog box, click the **OK** button (6 in Figure 11-4).
- Step 8.** In the Local Area Connection Properties dialog box, click the **OK** button (3 in Figure 11-3).
- Step 9.** In the Local Area Connection Status dialog box, click the **Close** button.
- Step 10.** Click the × button (2 in Figure 11-2) in the upper right of the Network and Dial-up Connections window.

Specifying computer name

Follow these steps to specify the computer name:

- Step 1.** Press **[System]**.
- Step 2.** Press **LAN Setup**.
- Step 3.** Press **Network Identification**.
- Step 4.** The System Properties dialog box (Figure 11-5) appears. Click the **Properties** button (1 in Figure 11-5). Press OK in the warning dialog box.

Figure 11-5

System Properties dialog box

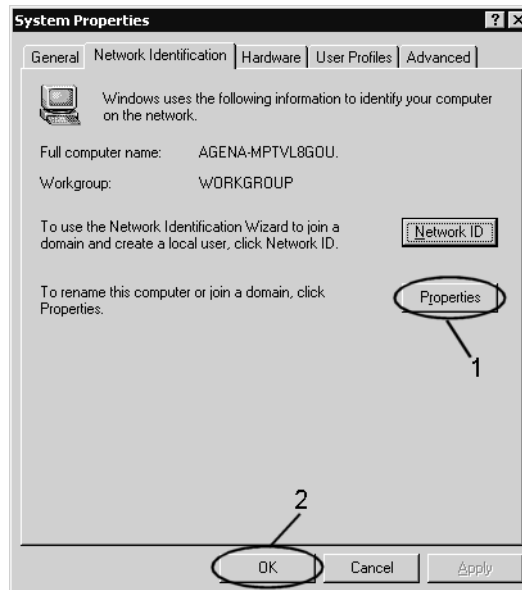

e5070buj043

Setting and Using the Control and Management Facilities Configuring the Network

Step 5. The Identification Changes dialog box (Figure 11-6) appears. Enter the computer name in the **Computer Name** box (1 in Figure 11-6).

Figure 11-6 Identification Changes dialog box

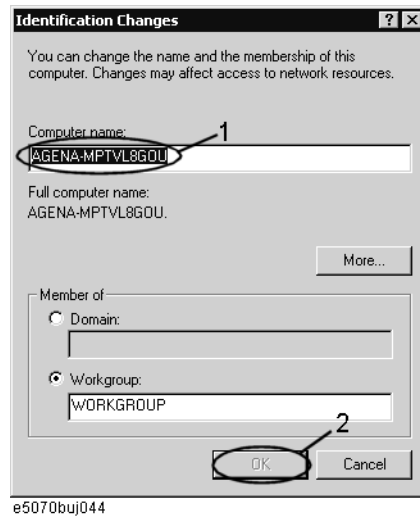

Step 6. The Network Identification dialog box (Figure 11-7) appears. Click the **OK** button.

Figure 11-7 Network Identification dialog box

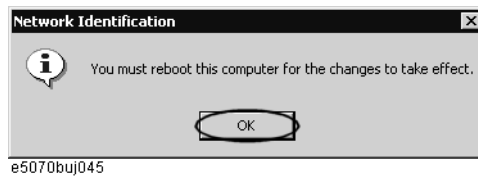

Step 7. In the Identification Changes dialog box, click the **OK** button (2 in Figure 11-6).

Step 8. In the System Properties dialog box, click the **OK** button (2 in Figure 11-5).

Step 9. The System Settings Change dialog box (Figure 11-8) appears. Click the **Yes** button to restart the 4287A.

Figure 11-8 System Settings Change dialog box

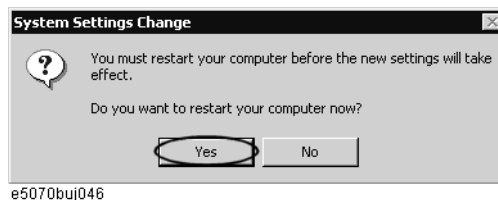

NOTE

Until the 4287A is restarted, changed setting does not take effect.

Setting the Built-in Speaker (Beep Sound)

The 4287A is provided with a built-in speaker for emitting beep sounds. The beep sounds serve two functions as shown in Table 11-1.

Table 11-1

4287A beep functions

Type	Function
Completion beep	Beep sound heard when saving of calibration data or measurement data is completed.
Warning beep	Beep sound heard when a warning message is displayed or when the result of the BIN sort function (comparator) is “pass” or “fail.”

Turning the completion beep ON or OFF

The following procedure is used to turn the completion beep ON or OFF.

NOTE

For how to perform the instruction “press the key (softkey) in the softkey menu” mentioned in the procedure, see “13. Softkeys” on page 87.

- Step 1.** Press the **[System]** key on the front panel to display the System softkey menu.
- Step 2.** Press the **BEEPER MENU** key in the softkey menu to display the BEEPER MENU softkey menu.
- Step 3.** Press the **BEEP DONE []** key in the softkey menu to turn the completion beep ON or OFF (the setting toggles with each press of the button).

Softkey Label	Completion Beep Setting
BEEP DONE [ON]	ON
BEEP DONE [OFF]	OFF

NOTE

Pressing the **PLAY BEEP DONE** key in the BEEPER MENU softkey menu allows you to hear the completion beep to test its operation.

Turning the warning beep ON or OFF

The following procedure is used to turn the warning beep ON or OFF.

NOTE

For how to perform the instruction “press the key (softkey) in the softkey menu” mentioned in the procedure, see “13. Softkeys” on page 87.

- Step 1.** Press the **[System]** key on the front panel to display the System softkey menu.

Setting and Using the Control and Management Facilities

Setting the Built-in Speaker (Beep Sound)

- Step 2.** Press the **BEEPER MENU** key in the softkey menu to display the BEEPER MENU softkey menu.
- Step 3.** Press the **BEEP WARN []** key in the softkey menu to turn the warning beep ON or OFF (the setting toggles with each press of the button).

Softkey Label	Warning Beep Setting
BEEP WARN [ON]	ON
BEEP WARN [OFF]	OFF

NOTE

Pressing the **PLAY BEEP WARN** key in the BEEPER MENU softkey menu allows you to hear the completion beep to test its operation.

Switching the beep sound that indicates the BIN sort function result (Pass or Fail)

The following procedure is used to set whether the beep sound indicates that the BIN sort function is “Pass” (entered in good BIN) or “Fail” (not entered in good BIN).

NOTE

For how to perform the instruction “press the key (softkey) in the softkey menu” mentioned in the procedure, see “13. Softkeys” on page 87.

- Step 1.** Press the **[System]** key on the front panel to display the System softkey menu.
- Step 2.** Press the **BEEPER MENU** key in the softkey menu to display the BEEPER MENU softkey menu.
- Step 3.** Press the **BEEP COMPARATOR []** key in the softkey menu to switch the condition for sounding the beep (Pass or Fail) (the setting toggles with each press of the button).

Softkey Label	Beep Setting According to BIN Sort Result
BEEP COMPARATOR [FAIL]	Beep sounds in case of Fail (not entered in good BIN).
BEEP COMPARATOR [PASS]	Beep sounds in case of Pass (entered in good BIN).

NOTE

Turning ON/OFF the beep sound for the BIN sort results is set by the procedure described in “Turning the warning beep ON or OFF” on page 233.

Locking the Front Panel Keys, Keyboard and Mouse

You can lock the operation of any of the input devices, including the 4287A front panel keys, the attached keyboard, and the attached mouse. Using this function will prevent accidental operation of devices not intended for use.

Locking the front panel keys and keyboard

With the exception of the standby switch (⏻), all of the keys on the front panel and keyboard can be made inoperative by following the procedure described below.

NOTE

After the front panel keys and keyboard have been locked, they (with the exception of the standby switch) cannot be used to return the lock to OFF.

For how to perform the instruction “press the key (softkey) in the softkey menu” mentioned in the procedure, see “13. Softkeys” on page 87.

- Step 1.** Press the **[System]** key on the front panel to display the System softkey menu.
- Step 2.** Press the **KEY LOCK MENU** key in the softkey menu to display the KEY LOCK MENU softkey menu.
- Step 3.** Press the **KBD LOCK []** key in the softkey menu to switch the lock status of the front keys and keyboard between ON or OFF (the setting toggles with each press of the button).

Softkey Label	Lock Status of Front Keys
KBD LOCK [ON]	ON (inoperative status)
KBD LOCK [OFF]	OFF (operative status)

NOTE

To set the lock status of the front keys to OFF, perform any of the following operations.

- Use the mouse to press the **KBD LOCK []** key in the softkey menu (or perform the same operation in the menu bar^{*1}).
- Use the mouse to execute **8. Help - 2. Frontkey - Preset** from the menu bar^{*1} to return the 4287A settings to the preset condition. In the preset condition, the lock function is OFF.
- Execute either of the above operations by sending GPIB commands from an external controller to the 4287A. For how to use GPIB commands, see the *Programming Manual*.
- Press the standby switch (⏻) on the front panel to completely turn OFF the power. When the standby switch is pressed again to turn the power ON, the 4287A power-on-settings will become valid. In the power-on-setting, the lock functions of the front keys, keyboard and mouse are all OFF.

*1. For how to operate the menu bar, see “2. Measurement display menu bar” on page 84.

Locking the keyboard

All of the keys on the keyboard connected to the 4287A can be made inoperative by following the procedure described below.

NOTE Once the keyboard has been locked, the locked condition cannot be released until the power has been turned OFF and then ON again.

For how to perform the instruction “press the key (softkey) in the softkey menu” mentioned in the procedure, see “13. Softkeys” on page 87.

- Step 1.** Press the **[System]** key on the front panel to display the System softkey menu.
- Step 2.** Press the **KEY LOCK MENU** key in the softkey menu to display the KEY LOCK MENU softkey menu.
- Step 3.** Press the **KBD LOCK []** key in the softkey menu. The dialog box shown in Figure 11-9 appears.

Figure 11-9

Keyboard lock dialog box



- Step 4.** Press the **OK** button in the dialog box to set the keyboard lock to ON.

NOTE Press the **Cancel** button in the dialog box if the keyboard lock should not be ON.

For how to press buttons in dialog boxes, see “4287A Key Operation Overview” on page 99.

The keyboard lock status can be confirmed by the softkey label.

Softkey Label	Keyboard Lock Status
KBD LOCK [ON]	ON (inoperative status)
KBD LOCK [OFF]	OFF (operative status)

NOTE To set the keyboard lock status to OFF, press the standby switch (⏻) on the front panel to completely turn OFF the power. When the standby switch is pressed again, the 4287A power-on-settings will become valid. In the power-on-setting, the lock functions of the front keys, keyboard and mouse are all OFF.

Locking the mouse

The mouse connected to the 4287A can be made inoperative.

NOTE

After the mouse has been locked, it cannot be used to return the mouse lock to OFF.

For how to perform the instruction “press the key (softkey) in the softkey menu” mentioned in the procedure, see “13. Softkeys” on page 87.

- Step 1.** Press the **[System]** key on the front panel to display the System softkey menu.
- Step 2.** Press the **KEY LOCK MENU** key in the softkey menu to display the KEY LOCK MENU softkey menu.
- Step 3.** Press the **MOUSE LOCK []** key in the softkey menu to turn the mouse lock ON or OFF (the setting toggles with each press of the button).

Softkey Label	Mouse Lock Status
MOUSE LOCK [ON]	ON (inoperative status)
MOUSE LOCK [OFF]	OFF (operative status)

NOTE

To set the mouse lock to OFF, use any of the following methods.

- Use the front keys or the keyboard to press the **MOUSE LOCK []** key in the softkey menu (or perform the same operation in the menu bar^{*1}).
 - Press the **[Preset]** key on the front panel (or use the front keys or the keyboard to perform the same operation on the menu bar^{*1}) to return the 4287A settings to the preset condition. In the preset condition, the lock function of the front keys and the mouse is OFF.
 - Execute either of the above operations by sending GPIB commands from an external controller to the 4287A. For how to use GPIB commands, see the *Programming Manual*.
 - Press the standby switch (⏻) on the front panel to completely turn OFF the power. When the standby switch is pressed again to turn the power ON, the 4287A power-on-settings will become valid. In the power-on-setting, the lock functions of the front keys, keyboard and mouse are all OFF.
-

*1. For how to operate the menu bar, see “2. Measurement display menu bar” on page 84.

Locking the front panel keys, keyboard and mouse simultaneously

With the exception of the standby switch (⏻), all of the front panel keys, the attached keyboard, and the attached mouse can be made inoperative at the same time.

NOTE

Once the front keys, keyboard and mouse have been locked, the lock can only be released by sending a GPIB command from an external controller or by turning the power off and then on again.

For how to perform the instruction “press the key (softkey) in the softkey menu” mentioned in the procedure, see “13. Softkeys” on page 87.

-
- Step 1.** Press the **[System]** key on the front panel to display the System softkey menu.
- Step 2.** Press the **KEY LOCK MENU** key in the softkey menu to display the KEY LOCK MENU softkey menu.

Press the **LOCK ALL** key in the softkey menu. The dialog box shown in Figure 11-10 appears.

Figure 11-10 Lock all dialog box

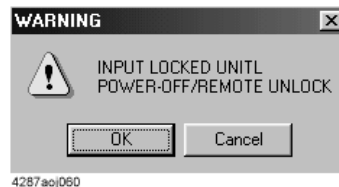

- Step 3.** Press the **OK** button in the dialog box to simultaneously lock the front panel keys, keyboard and mouse.

NOTE

To turn the lock OFF after all the front keys, keyboard and mouse have been locked, use any of the following procedures.

- From the external controller, send the GPIB command to set the front key or mouse lock to OFF. To turn OFF the keyboard lock, it is necessary to once set the power to off and then turn it on again.
- Send the GPIB command for executing preset to return the 4287A settings to the preset condition. In the preset condition, the lock function of the front keys and mouse is OFF. For the preset command, see the *Programming Manual*.
- Press the standby switch (⏻) on the front panel to completely turn OFF the power. When the standby switch is pressed again to turn the power ON, the 4287A power-on-settings will become valid. In the power-on-setting, the lock functions of the front keys, keyboard and mouse are all OFF.

To cancel the operation for locking everything, press the **Cancel** button in the dialog box.

For how to press buttons in dialog boxes, see “4287A Key Operation Overview” on page 99.

Turning OFF the LCD Display's Backlight

The following procedure can be used to turn off the backlight (illumination) of the 4287A's LCD display. Turning off the illumination helps extend the service life of the backlight when the unit is used in continuous operation.

NOTE

For how to perform the instruction "press the key (softkey) in the softkey menu" mentioned in the procedure, see "13. Softkeys" on page 87.

- Step 1.** Press the **[System]** key on the front panel to display the System softkey menu.
- Step 2.** Press the **SERVICE MENU** key in the softkey menu to display the SERVICE MENU softkey menu.
- Step 3.** Press the **BACK LIGHT []** key to turn the backlight ON or OFF (the setting toggles with each press of the button).

Softkey Label	Backlight Status
BACK LIGHT [ON]	On (illuminated)
BACK LIGHT [OFF]	Off (no illumination)

NOTE

If the backlight is turned off, nothing is visible on the LCD display. When operating the softkeys manually in this condition, it is necessary to view the display on an external monitor connected to the 4287A.

If the backlight is turned off by mistake and operation is impeded, press the **[Preset]** key on the front panel to return the 4287A settings to the preset condition (in the preset condition the backlight is on).

System Recovery

By executing system recovery, you can return the system of the 4287A (the Windows operating system and the firmware) to the factory state (at the time of purchase^{*1}).

Types of system recoveries

The following two types of system recoveries are available.

Factory recovery

Returns the contents of the C drive to the factory state.

User recovery^{*2}

Returns the contents of the C drive to a user-specified state. To use this function, you must prepare for recovery in advance. For information on preparation, see “Procedure to create the user backup image” on page 244 for information on the execution. Also, see “Procedure to execute the user recovery function” on page 247.

Notes on executing system recovery

Executing system recovery causes the following:

- In addition to the Windows operating system and the firmware, the following settings of the 4287A are returned to the factory state.
 - Network setting
 - GPIB setting
 - Printer setting
- The driver for the supported printer installed after purchase is deleted.
- You need to execute initial registration again.

Files you created using the save function (files in the D drive) are not affected, but we recommend backing them up before executing system recovery for precautionary purposes.

*1. If the hard disk failed and has been replaced after purchase, the state when the replacement was performed is recovered.

*2. This function is available when the volume label on the hard disk is IZ202 or higher.

Procedure to execute system recovery

This section describes how to return the contents of the C drive to the factory state.

NOTE You need the keyboard for this operation.

- Step 1.** Shut down the 4287A.
- Step 2.** Connect the keyboard to the 4287A.
- Step 3.** Insert the disk for the system recovery into the floppy disk drive of the 4287A.
- Step 4.** Press the standby switch of the 4287A to turn it on.
- Step 5.** When the screen as shown in the figure below appears, press and hold **[Esc]** of the keyboard until this screen disappears.

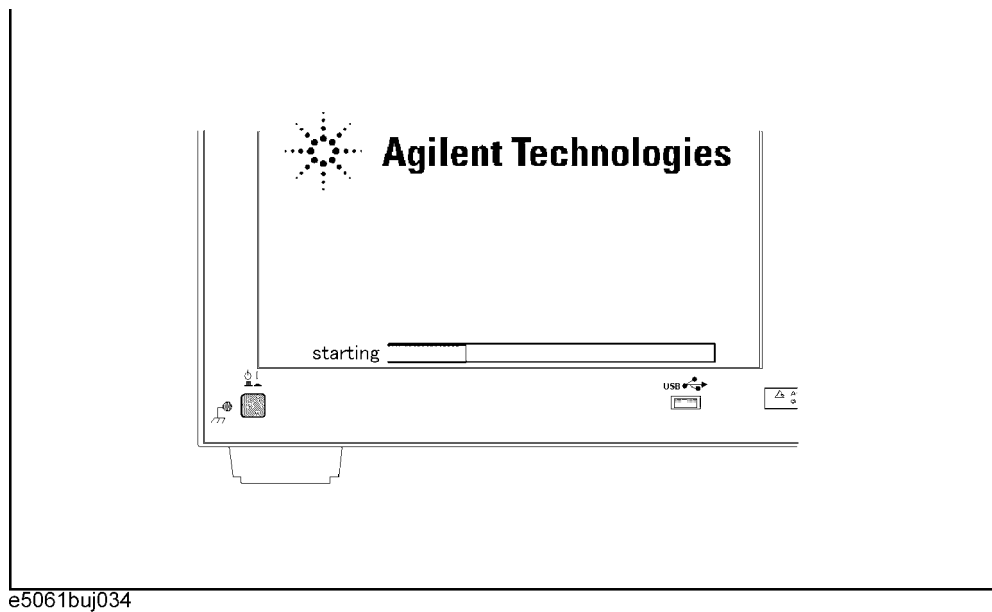

NOTE After several seconds, the next screen appears automatically even if you do not press any key, so do not miss it.

If the above message does not appear, the instrument is at fault; contact your local Agilent customer center listed at the end of this manual or distributor.

Setting and Using the Control and Management Facilities

System Recovery

Step 6. The following screen appears. Select “+Removable Devices” with of the keyboard, and press of the keyboard.

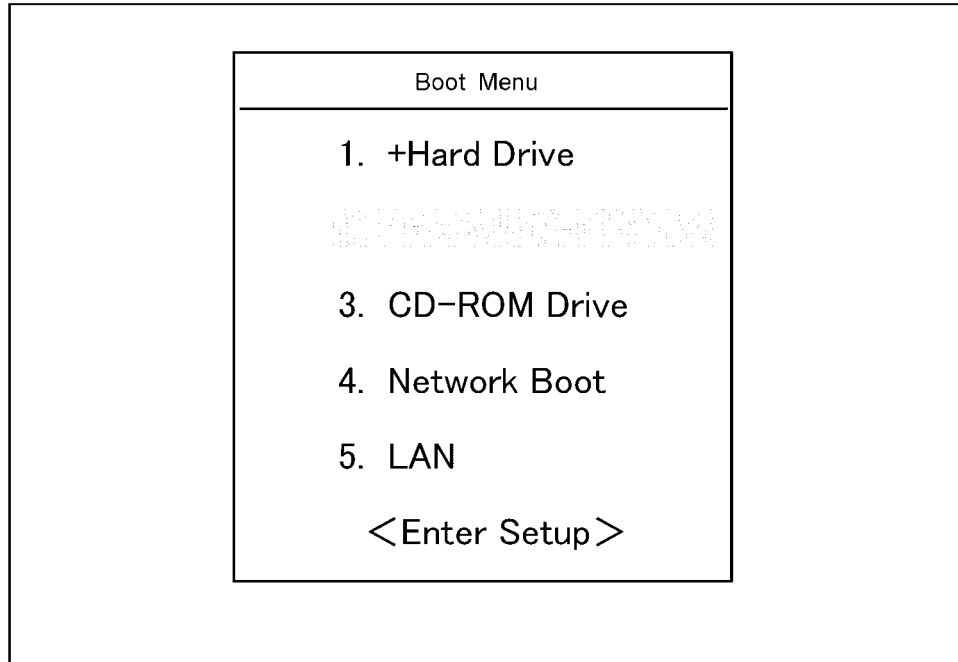

Step 7. The message as shown below appears. Press of the keyboard. If you want to cancel the factory recovery, press here.

Agilent Technologies System Utilities
Recovery & Backup Options

Choose One of the following:

-
1. Recover Factory Backup Image
 2. Create User Backup Image
 3. Recover User Backup Image
 4. Exit
-

Enter a Choice: _

NOTE

If the above message does not appear, the instrument or the disk for the system recovery is at fault; contact your local Agilent customer center listed at the end of this manual or distributor.

- Step 8.** The message as shown below appears. Press **C** of the keyboard. If you want to cancel the system recovery, press **E** here.

You chose to Restore your system by installing the original factory installed OS and system software.

WARNING: Press C to Continue only if you are sure that you want to proceed. The C: Drive will be completely overwritten with no chance of recovering any data. Use Option 1 to recover the system from a serious malfunction caused by corrupted or inadvertently deleted files on the system's primary C: partition.

Press C to Continue or E to Exit: _

- Step 9.** The message as shown below appears. Press **C** of the keyboard to start the factory recovery. If you want to cancel the factory recovery, press **E** here.

CAUTION! Interrupting this process may leave the system in an unstable state. Allow the software to complete the backup and recovery process. This may take up to 20 minutes depending on the system configuration.

Press C to Continue or E to Exit: _

CAUTION

Never turn off the power during the factory recovery because doing so may cause serious damage to the 4287A.

- Step 10.** The factory recovery will be complete in about 5 minutes. When the factory recovery is complete, the message as shown below appears. Press **Ctrl**, **Alt**, and **Delete** of the keyboard at the same time to restart.

Remove the disk and Press CLT+ALT+DEL to restart your system.

NOTE

If the above message does not appear, the instrument is at fault; contact your local Agilent customer center listed at the end of this manual or distributor.

- Step 11.** After restart, the screen for initial registration appears. Execute initial registration. For information on the execution procedure, refer to “*Initial Registration of 4287A*” on page 40.

Procedure to create the user backup image

This section describes how to create the user backup image. The C drive contents saved in this creation are recalled when the user recovery function is executed.

NOTE This function is available when the volume label on the hard disk is IZ202 or higher.

NOTE You need the keyboard for this operation.

- Step 1.** Shut down the 4287A.
- Step 2.** Connect the keyboard to the 4287A.
- Step 3.** Insert the disk for the system recovery into the floppy disk drive of the 4287A.
- Step 4.** Press the standby switch of the 4287A to turn it on.
- Step 5.** When the screen as shown in the figure below appears, press and hold **Esc** of the keyboard until this screen disappears.

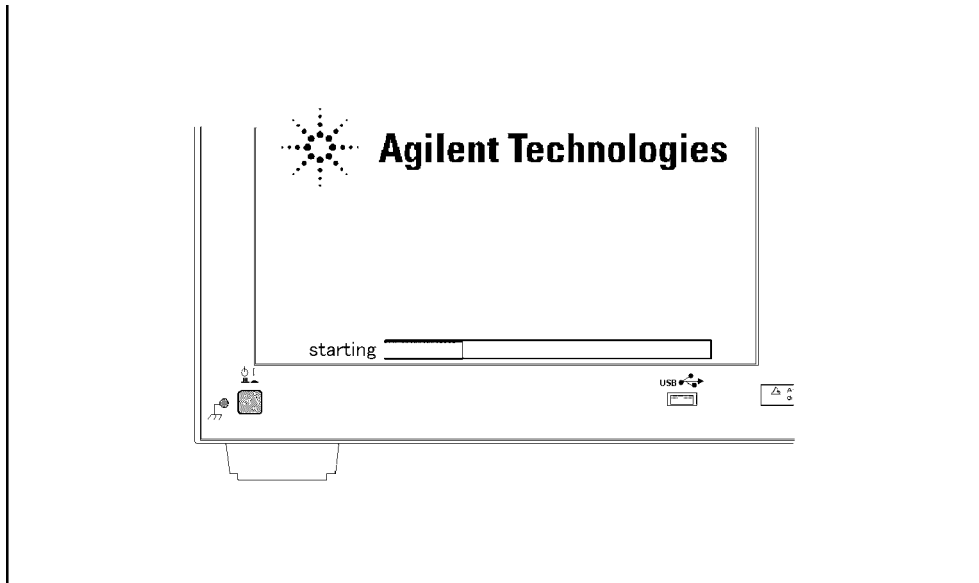

e5061buj034

NOTE After several seconds, the next screen appears automatically even if you do not press any key, so do not miss it.

If the above message does not appear, the instrument is at fault; contact your local Agilent customer center listed at the end of this manual or distributor.

Step 6. The following screen appears. Select “+Removable Devices” with of the keyboard, and press of the keyboard.

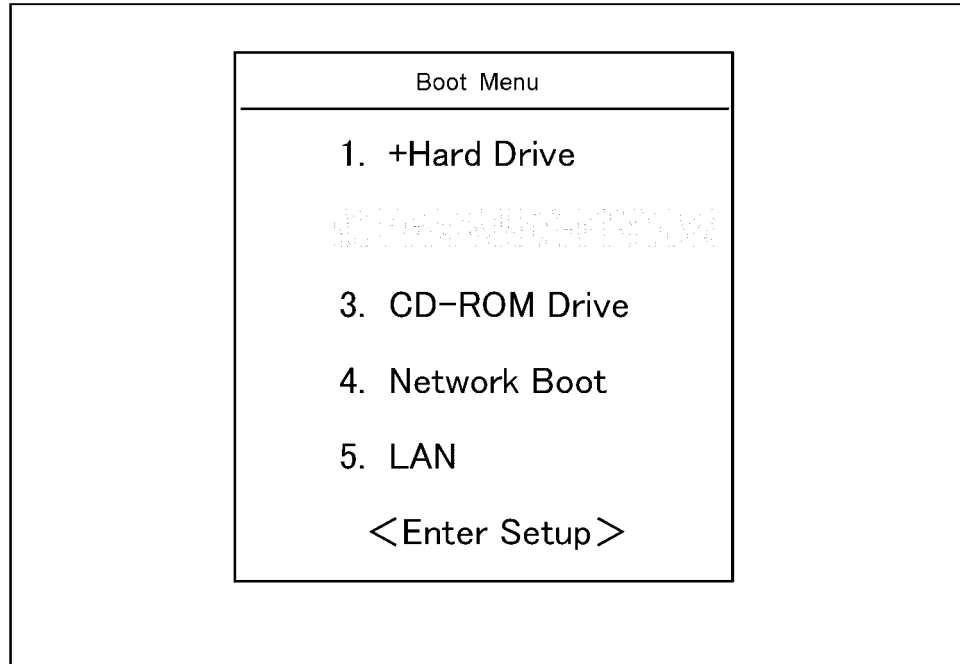

Step 7. The message as shown below appears. Press of the keyboard. If you want to cancel the create user backup image, press here.

```
Agilent Technologies System Utilities
Recovery & Backup Options
```

Choose One of the following:

-
1. Recover Factory Backup Image
 2. Create User Backup Image
 3. Recover User Backup Image
 4. Exit
-

Enter a Choice: _

NOTE

If the above message does not appear, the instrument or the disk for the system recovery is at fault; contact your local Agilent customer center listed at the end of this manual or distributor.

Setting and Using the Control and Management Facilities

System Recovery

- Step 8.** The message as shown below appears. Press **C** of the keyboard. If you want to cancel the create user backup image, press **E** here.

You chose to create a backup image file of your system.

The system will perform a quick integrity check of the file structure on the C: Drive. It will then copy the C: partition to an image file and store it on the System Recovery partition.

Press C to Continue or E to Exit: _

- Step 9.** The message as shown below appears. Press **C** of the keyboard to start the create user backup image. If you want to cancel the create user backup image, press **E** here.

CAUTION! Interrupting this process may leave the system in an unstable state. Allow the software to complete the backup and recovery process. This may take up to 20 minutes depending on the system configuration.

Press C to Continue or E to Exit: _

CAUTION

Never turn off the power during the create user backup image because doing so may cause serious damage to the 4287A.

- Step 10.** The create user backup image will be complete in about 5 minutes. When the create user backup image is complete, the message as shown below appears. Press **Ctrl**, **Alt**, and **Delete** of the keyboard at the same time to restart.

Remove the disk and Press CLT+ALT+DEL to restart your system.

NOTE

If the above message does not appear, the instrument is at fault; contact your local Agilent customer center listed at the end of this manual or distributor.

Procedure to execute the user recovery function

Returns the contents of the C drive to a user-specified state. To use this function, you must create the user backup image in advance. For more information, see the description “Procedure to create the user backup image” on page 244.

NOTE This function is available when the volume label on the hard disk is IZ202 or higher.

NOTE You need the keyboard for this operation.

- Step 1.** Shut down the 4287A.
- Step 2.** Connect the keyboard to the 4287A.
- Step 3.** Insert the disk for the system recovery into the floppy disk drive of the 4287A.
- Step 4.** Press the standby switch of the 4287A to turn it on.
- Step 5.** When the screen as shown in the figure below appears, press and hold **Esc** of the keyboard until this screen disappears.

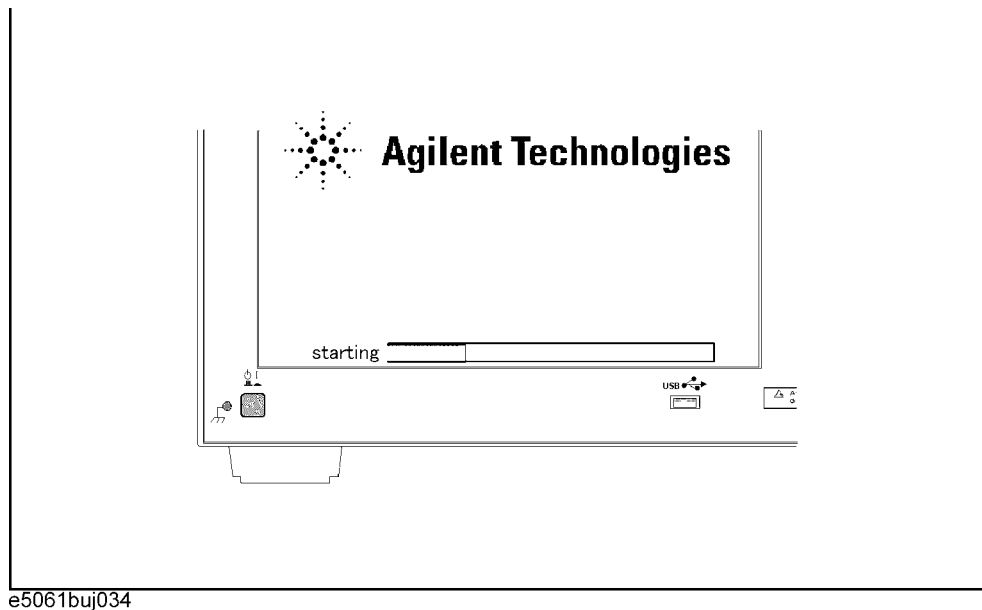

NOTE After several seconds, the next screen appears automatically even if you do not press any key, so do not miss it.

If the above message does not appear, the instrument is at fault; contact your local Agilent customer center listed at the end of this manual or distributor.

Setting and Using the Control and Management Facilities

System Recovery

Step 6. The following screen appears. Select “+Removable Devices” with of the keyboard, and press of the keyboard.

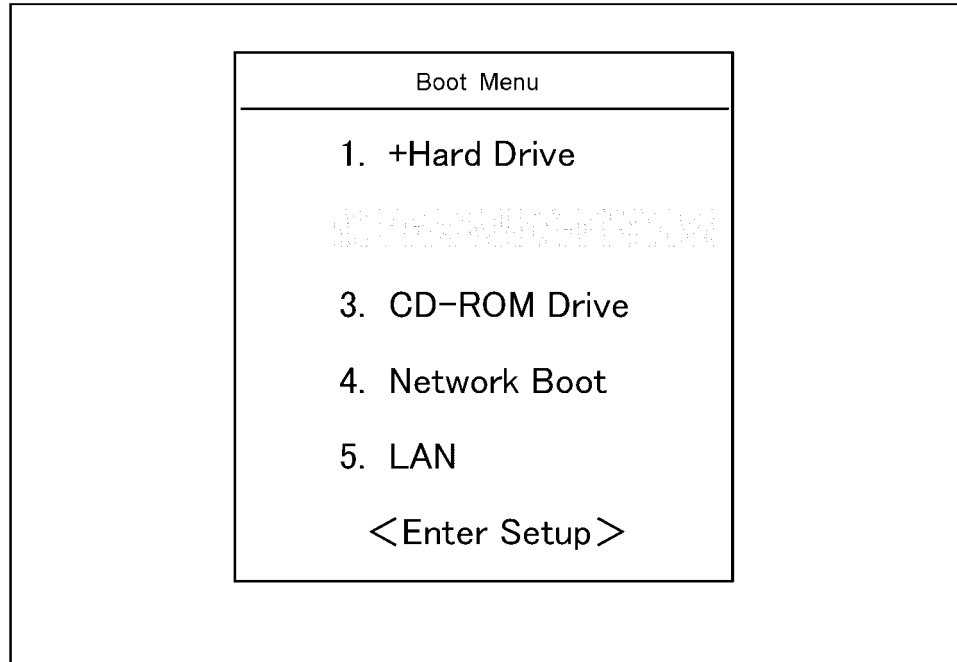

Step 7. The message as shown below appears. Press of the keyboard. If you want to cancel the user recovery, press here.

```
Agilent Technologies System Utilities
Recovery & Backup Options
```

```
Choose One of the following:
```

-
1. Recover Factory Backup Image
 2. Create User Backup Image
 3. Recover User Backup Image
 4. Exit
-

```
Enter a Choice: _
```

NOTE

If the above message does not appear, the instrument or the disk for the system recovery is at fault; contact your local Agilent customer center listed at the end of this manual or distributor.

- Step 8.** The message as shown below appears. Press **C** of the keyboard. If you want to cancel the user recovery, press **E** here.

You chose to recover your own system backup image file.

WARNING: Press C to Continue only if you are sure that you want to proceed. The C: partition will be completely overwritten with no chance of recovering any data. Use Option 3 to recover the system from a serious malfunction caused by corrupted or inadvertently deleted files on the system's primary C: partition.

Press C to Continue or E to Exit: _

- Step 9.** The message as shown below appears. Press **C** of the keyboard to start the user recovery. If you want to cancel the user recovery, press **E** here.

CAUTION! Interrupting this process may leave the system in an unstable state. Allow the software to complete the backup and recovery process. This may take up to 20 minutes depending on the system configuration.

Press C to Continue or E to Exit: _

CAUTION

Never turn off the power during the system recovery because doing so may cause serious damage to the 4287A.

- Step 10.** The user recovery will be complete in about 5 minutes. When the user recovery is complete, the message as shown below appears. Press **Ctrl**, **Alt**, and **Delete** of the keyboard at the same time to restart.

Remove the disk and Press CLT+ALT+DEL to restart your system.

NOTE

If the above message does not appear, the instrument is at fault; contact your local Agilent customer center listed at the end of this manual or distributor.

12 **Specifications and Supplemental
Performance Characteristics**

Specifications and Supplemental Performance Characteristics

Specifications describe the instrument's warranted performance over the temperature range of 5 °C to 40 °C (except as noted). Supplemental performance characteristics are intended to provide helpful information for using certain non-warranted performance parameters with the instrument. These are denoted as SPC (supplemental performance characteristics), typical, or nominal. Warm-up time must be at least 30 minutes after turning the power on for all specifications.

Basic Measurement Characteristics

Measurement parameters

Impedance parameters	Z , Y , Ls, Lp, Cs, Cp, Rs, Rp, X, G, B, D, Q, θ_z [°], θ_z [rad], θ_y [°], θ_y [rad] (A maximum of four parameters can be displayed at one time.)
----------------------	--

Measurement range

Measurement range	200 mΩ to 3 kΩ Frequency = 1 MHz Averaging factor = 8 Oscillator level ≥ -33 dBm Measurement uncertainty ≤ ±10 % Calibration is performed within 23 °C ±5 °C Measurement is performed within ±5 °C of calibration temperature)
-------------------	--

Source characteristics

Frequency

Range	1 MHz to 3 GHz
Resolution	100 kHz
Uncertainty	±10 ppm (23 ±5°C) ±20 ppm (5°C to 40°C)

Oscillator Level

Range	
Cable length: 1 m	
Power (when 50 Ω LOAD is connected to test port)	- 40 dBm to 1 dBm (Frequency ≤ 1 GHz) - 40 dBm to 0 dBm (Frequency > 1GHz ^{*1})
Current (when SHORT is connected to test port)	0.0894 mArms to 10 mArms (Frequency ≤ 1 GHz) 0.0894 mArms to 8.94 mArms (Frequency > 1 GHz ^{*1})
Voltage (when OPEN is connected to test port)	4.47 mVrms to 502 mVrms (Frequency ≤ 1 GHz) 4.47 mVrms to 447 mVrms (Frequency > 1 GHz ^{*1})
Cable length: 2 m	(when Option 002 is used)
Power	Subtract the following attenuation from the power (setting value) at 1 m cable length: Attenuation [dB] = $0.37 \times \sqrt{F}$ (F: Frequency [GHz])

Specifications and Supplemental Performance Characteristics
Basic Measurement Characteristics

Resolution	0.1 dB*2
Uncertainty	
Cable length: 1 m	
Power (when 50 Ω LOAD is connected to test port)	
Frequency \leq 1 GHz	± 2 dB(23 \pm 5°C) ± 4 dB(5°C to 40°C)
Frequency $>$ 1 GHz	± 3 dB(23 \pm 5°C) ± 5 dB (5°C to 40°C)
Cable length: 2 m	(when Option 002 is used)
Power	Add 1 dB to the uncertainty at 1 m cable length.

- *1. It is possible to set more than 0 dBm (447 mV, 8.94 mA) oscillator level at frequency $>$ 1 GHz. However, the characteristics at this setting are not guaranteed.
*2. When the unit is set at mV or mA, the entered value is rounded to 0.1 dBm resolution.

Output Impedance

Output Impedance	50 Ω (nominal)
------------------	----------------

Measurement accuracy

Conditions for Defining Accuracy

Temperature	23 ±5°C
Accuracy-specified plane	7-mm connector of 3.5-mm-to-7-mm adapter connected to 3.5-mm terminal of test heads

Measurement Uncertainty

When OPEN/SHORT/LOAD calibration is performed:	
Z , Y	$\pm(E_a + E_b)$ [%]
θ	$\pm \frac{(E_a + E_b)}{100}$ [rad]
L, C, X, B	$\pm(E_a + E_b) \times \sqrt{(1 + D_x^2)}$ [%]
R, G	$\pm(E_a + E_b) \times \sqrt{(1 + Q_x^2)}$ [%]
D	
at $\left D_x \tan\left(\frac{E_a + E_b}{100}\right) \right < 1$	$\pm \frac{(1 + D_x^2) \tan\left(\frac{E_a + E_b}{100}\right)}{1 \mp D_x \tan\left(\frac{E_a + E_b}{100}\right)}$
at $D_x \leq 0.1$	$\pm \frac{E_a + E_b}{100}$
Q	
at $\left Q_x \tan\left(\frac{E_a + E_b}{100}\right) \right < 1$	$\pm \frac{(1 + Q_x^2) \tan\left(\frac{E_a + E_b}{100}\right)}{1 \mp Q_x \tan\left(\frac{E_a + E_b}{100}\right)}$
at $\frac{10}{E_a + E_b} \geq Q_x \geq 10$	$\pm Q_x^2 \frac{E_a + E_b}{100}$

12. Specifications and Supplemental Performance Characteristics

Specifications and Supplemental Performance Characteristics
Basic Measurement Characteristics

When OPEN/SHORT/LOAD/LOW-LOSS C calibration is performed (SPC):	
$ Z , Y $	$\pm(E_a + E_b)$ [%]
θ	$\pm \frac{E_c}{100}$ [rad]
L, C, X, B	$\pm \sqrt{(E_a + E_b)^2 + (E_c D_x)^2}$ [%]
R, G	$\pm \sqrt{(E_a + E_b)^2 + (E_c Q_x)^2}$ [%]
D	
$\left D_x \tan\left(\frac{E_c}{100}\right) \right < 1$	$\pm \frac{(1 + D_x^2) \tan\left(\frac{E_c}{100}\right)}{1 \mp D_x \tan\left(\frac{E_c}{100}\right)}$
$D_x \leq 0.1$	$\pm \frac{E_c}{100}$
Q	
$\left Q_x \tan\left(\frac{E_c}{100}\right) \right < 1$	$\pm \frac{(1 + Q_x^2) \tan\left(\frac{E_c}{100}\right)}{1 \mp Q_x \tan\left(\frac{E_c}{100}\right)}$
$\frac{10}{E_c} \geq Q_x \geq 10$	$\pm Q_x^2 \frac{E_c}{100}$

Definition of Each Parameter

Dx =	Measurement value of D
Qx =	Measurement value of Q
Ea =	Within $\pm 5^\circ\text{C}$ from the calibration temperature. Measurement accuracy applies when the calibration is performed at $23^\circ\text{C} \pm 5^\circ\text{C}$. When the calibration is performed beyond $23^\circ\text{C} \pm 5^\circ\text{C}$, the measurement accuracy decreases to half that described.
Oscillator level ≥ -33 dBm	
Frequency ≥ 1 MHz, ≤ 100 MHz	± 0.65 [%]
Frequency > 100 MHz, ≤ 500 MHz	± 0.8 [%]

Frequency > 500 MHz, ≤ 1 GHz	±1.2 [%]
Frequency > 1 GHz, ≤ 1.8 GHz	±2.5 [%]
Frequency > 1.8 GHz, ≤ 3 GHz	±5 [%]
Oscillator level < -33 dBm	
Frequency ≥ 1 MHz, ≤ 100 MHz	±1 [%]
Frequency > 100 MHz, ≤ 500 MHz	±1.2 [%]
Frequency > 500 MHz, ≤ 1 GHz	±1.2 [%]
Frequency > 1 GHz, ≤ 1.8 GHz	±2.5 [%]
Frequency > 1.8 GHz, ≤ 3 GHz	±5 [%]
E _b =	$\pm \left(\frac{Z_s}{ Z_x } + Y_o \cdot Z_x \right) \times 100$ [%] (Z _x : Measurement value of Z)
E _c =	$\pm \left(0.06 + \frac{0.08 \times F}{1000} \right)$ [%] (F: Frequency [MHz])
Z _s =	Within ±5°C from the calibration temperature. Measurement accuracy applies when the calibration is performed at 23°C ±5°C. When the calibration is performed beyond 23°C ±5°C, the measurement accuracy decreases to half that described.
Oscillator level ≥ -33 dBm, Averaging factor ≥ 8	± (20 + 0.5 × F) [mΩ] (F: Frequency [MHz])
Oscillator level ≥ -33 dBm, Averaging factor < 7	± (50 + 0.5 × F) [mΩ] (F: Frequency [MHz])
Oscillator level < -33 dBm	± (100 + 0.5 × F) [mΩ] (F: Frequency [MHz])
Y _o =	Within ±5°C from the calibration temperature. Measurement accuracy applies when the calibration is performed at 23°C ±5°C. When the calibration is performed beyond 23°C ±5°C, the measurement accuracy decreases to half that described.
Oscillator level ≥ -33 dBm, Averaging factor ≥ 8	± (30 + 0.15 × F) [μS] (F: Frequency [MHz])
Oscillator level ≥ -33 dBm, Averaging factor < 7	± (50 + 0.15 × F) [μS] (F: Frequency [MHz])

Specifications and Supplemental Performance Characteristics
Basic Measurement Characteristics

Oscillator level < -33 dBm	$\pm (100 + 0.15 \times F) [\mu\text{S}]$ (F: Frequency [MHz])
----------------------------	--

At the following points, measurement error may exceed the specifications described here due to the 4287A's spurious characteristics:

109.7 MHz, 153.6 MHz, 177.2 MHz, 256.0 MHz, 329.1 MHz, 460.8 MHz, 768.0 MHz

Examples of Calculated Impedance Measurement Accuracy

Figure 12-1 Oscillator Level ≥ -33 dBm, Averaging Factor ≥ 8 , Temperature Deviation $\leq 5^\circ\text{C}$

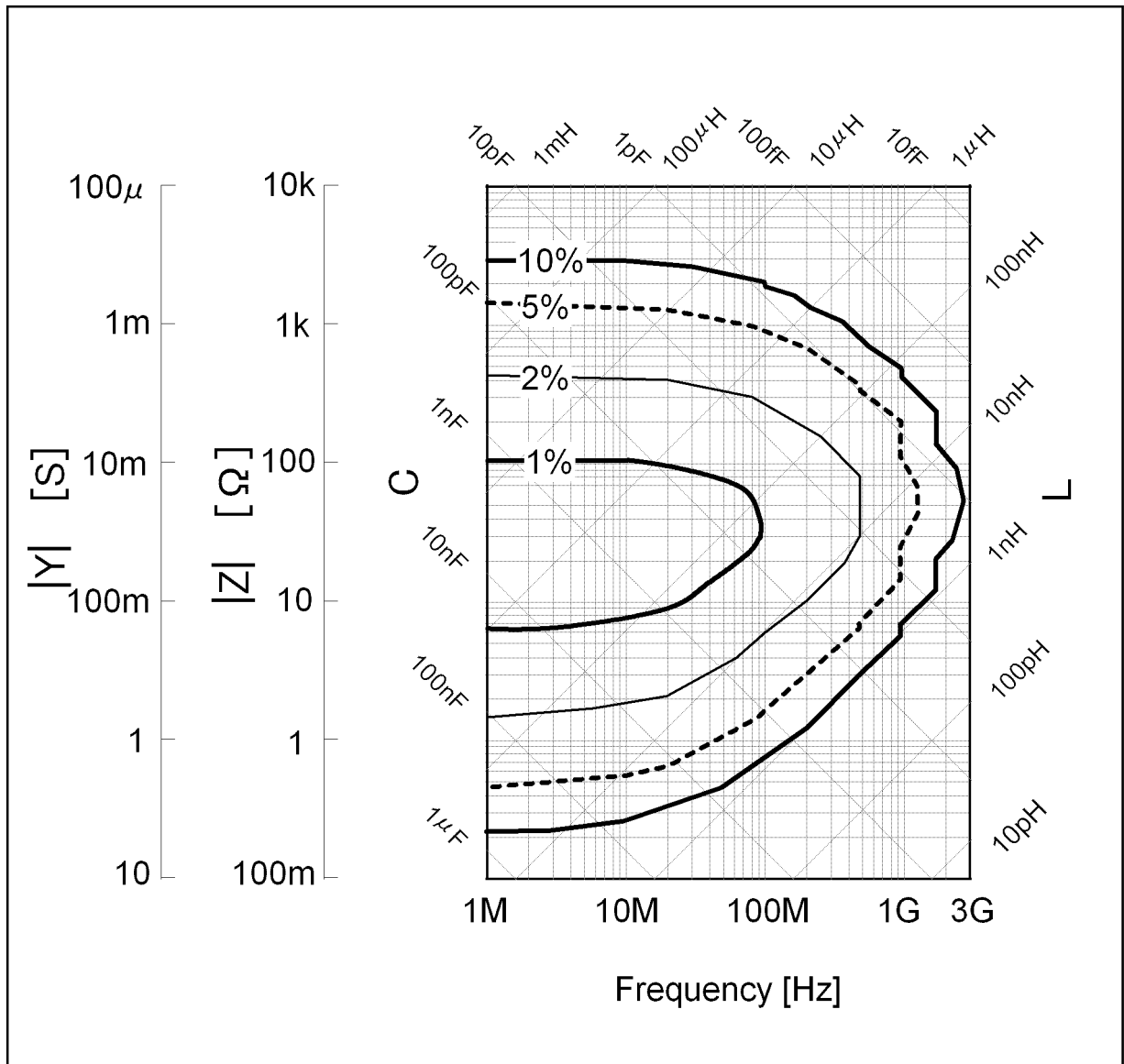

4287aoj152

Figure 12-2 Oscillator Level ≥ -33 dBm, Averaging Factor ≤ 7 , Temperature Deviation $\leq 5^\circ\text{C}$

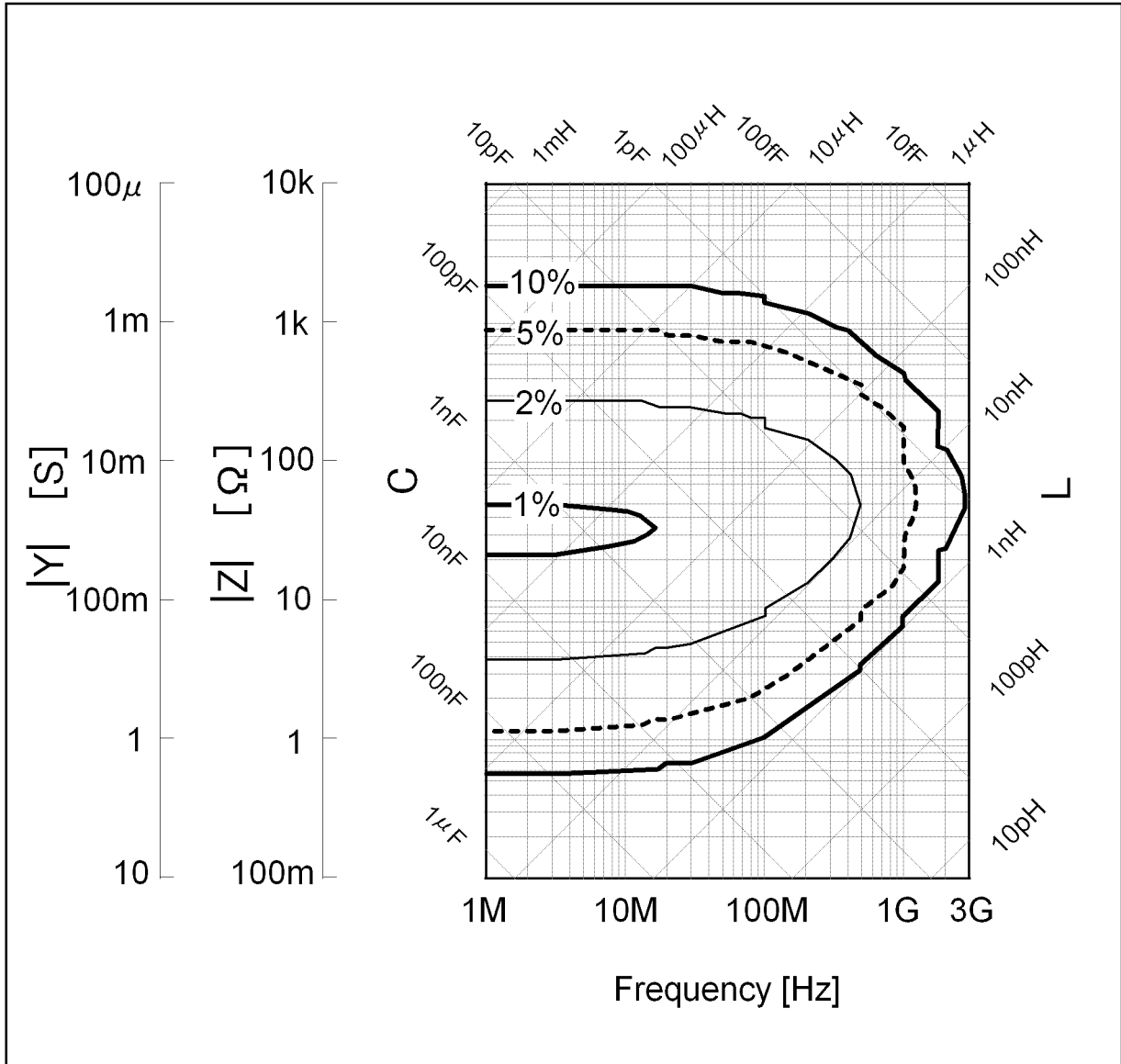

4287aaj153

12. Specifications and Supplemental Performance Characteristics

Figure 12-3 Oscillator Level < -33 dBm, Temperature Deviation $\leq 5^\circ\text{C}$

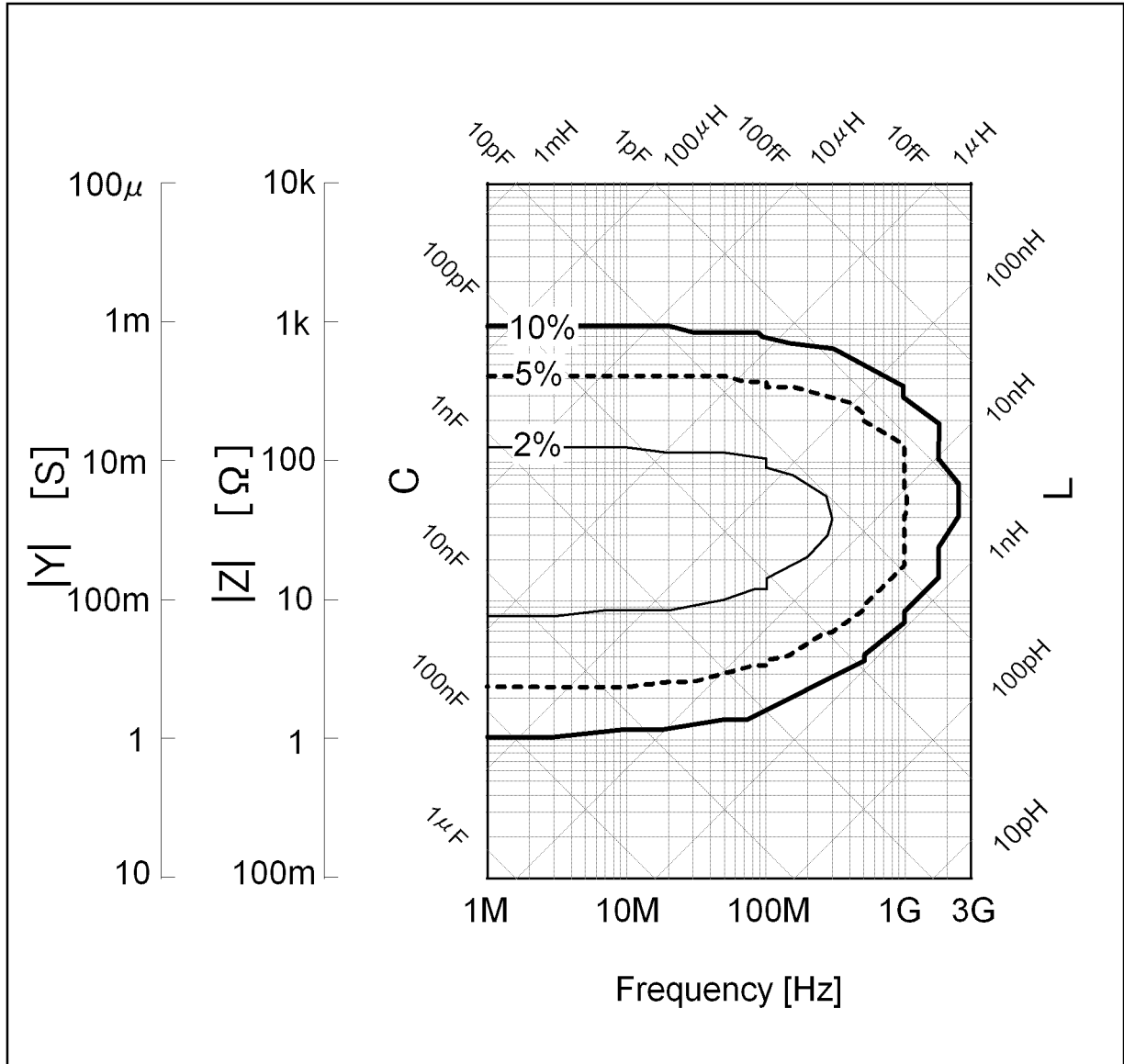

4287aoj154

Timing chart and measurement time (SPC)

Timing Chart of Handler Interface Signal (SPC)

Figure 12-4 Timing Chart of Handler Interface

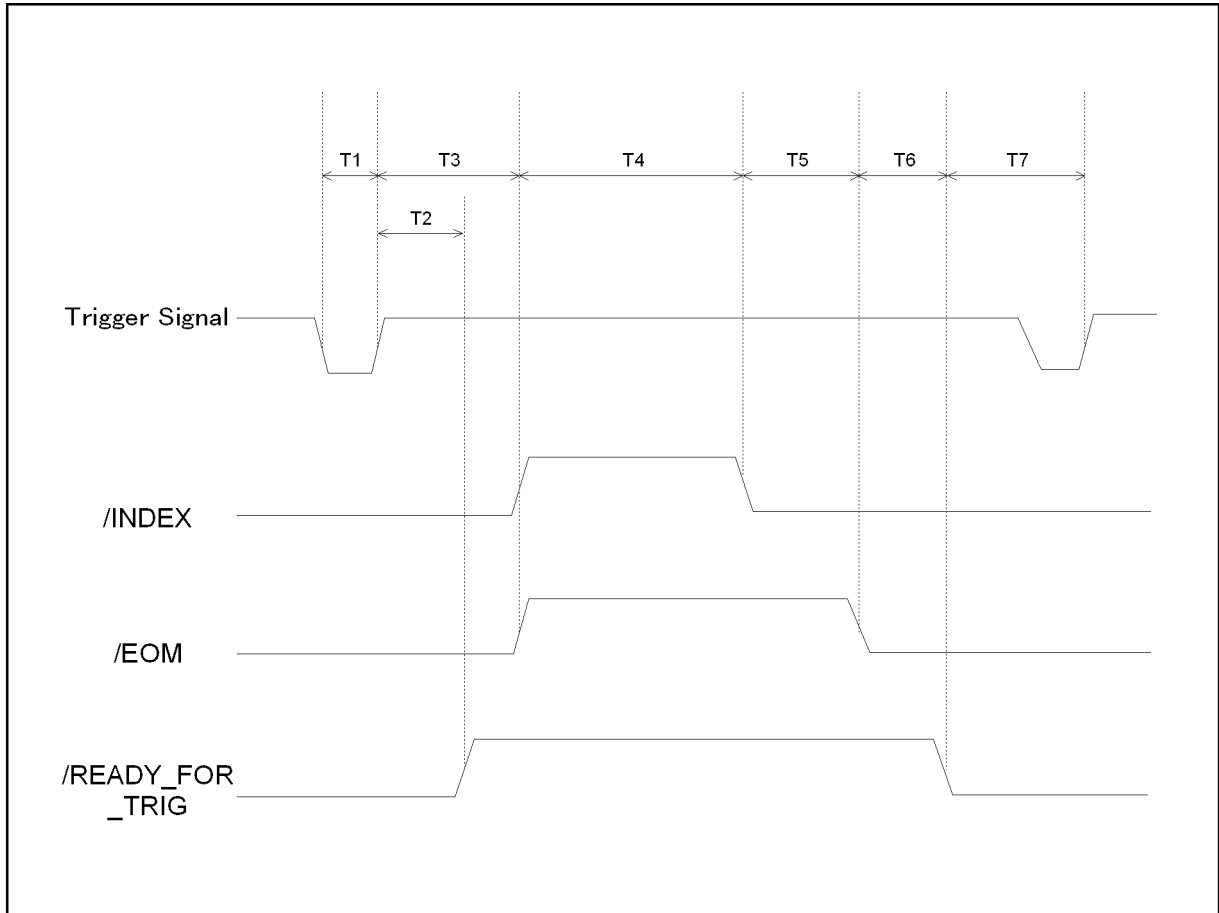

4287a0e155

Specifications and Supplemental Performance Characteristics
Basic Measurement Characteristics

Table 12-1 Value T1 through T (Typical)

Name		Test Condition				Timing		
		Screen Setting	Display	Rdc Meas.	Compa rator	Min.	Median	Max
T1	Trigger pulse width	-	-	-	-	2 μ s	-	-
T2	Trigger response time of Ready_for_Trig	-	-	-	-	-	0.3ms	0.5ms
T3	Trigger response time of INDEX and EOM	-	-	-	-	-	0.4ms	0.6ms
T4	Meas. Time ^{ε*1}	-	-	Off	-	-	5.7ms	5.9ms
		-	-	On	-	-	7.5ms	7.7ms
T5	Meas. data calculation time	-	-	-	Off	-	0.3ms	0.4ms
		-	-	-	On	-	0.4ms	0.4ms
T6	Ready_for_Trig setting time	1-point meas. Ls-Q meas.	Off	-	-	-	0.1ms	0.3ms
		1-point meas. Ls-Q meas.	On	On	On	-	9.8ms	10.2ms
		List Meas. 3-point meas. Ls-Q meas.	On	On	On	-	9.8ms	10.2ms
T7	Trigger wait time	-	-	0	-	0	-	-

*1. 1-point measurement, Trigger delay=0, point delay=0

Test condition for “Typical data”

The measurement time of 4287A is scattered to some extent by an overhead of the internal operation system and other conditions, so it is difficult to define the specification of handler interface timing. Thus, for your reference, we provide “typical” data on it in Table 13-1 by defining the following test condition.

Definition for “typical” data:

Median : Median value of running one minute of measurement data

Max. : Max. value of running one minute of measurement data

NOTE

1. The instrument’s operating system sometimes suffers interruptions during measurement, and we sometimes observe an extremely large overhead in handler interface timings. The table excludes such special cases, thus you can sometimes see timing over the max. value data shown in the table. If you make a handshake using the READY_FOR_TRIGGER signal of the handler interface, your test system can continue to work correctly regardless of such an irregular measurement time drift.

2. If your system communicates with external devices, you will see longer timing results than those on the table.

3. In the case of using a bus trigger in the GPIB system instead of the handler interface, you should measure the test cycle time for yourself, because the system performance depends heavily on the system parameters. Of course, you will see much longer test cycle times from your system's software overhead.

Details of Measurement Time (T4) (Typical)

Figure 12-5 Measurement Time T4 for Single Point Measurement

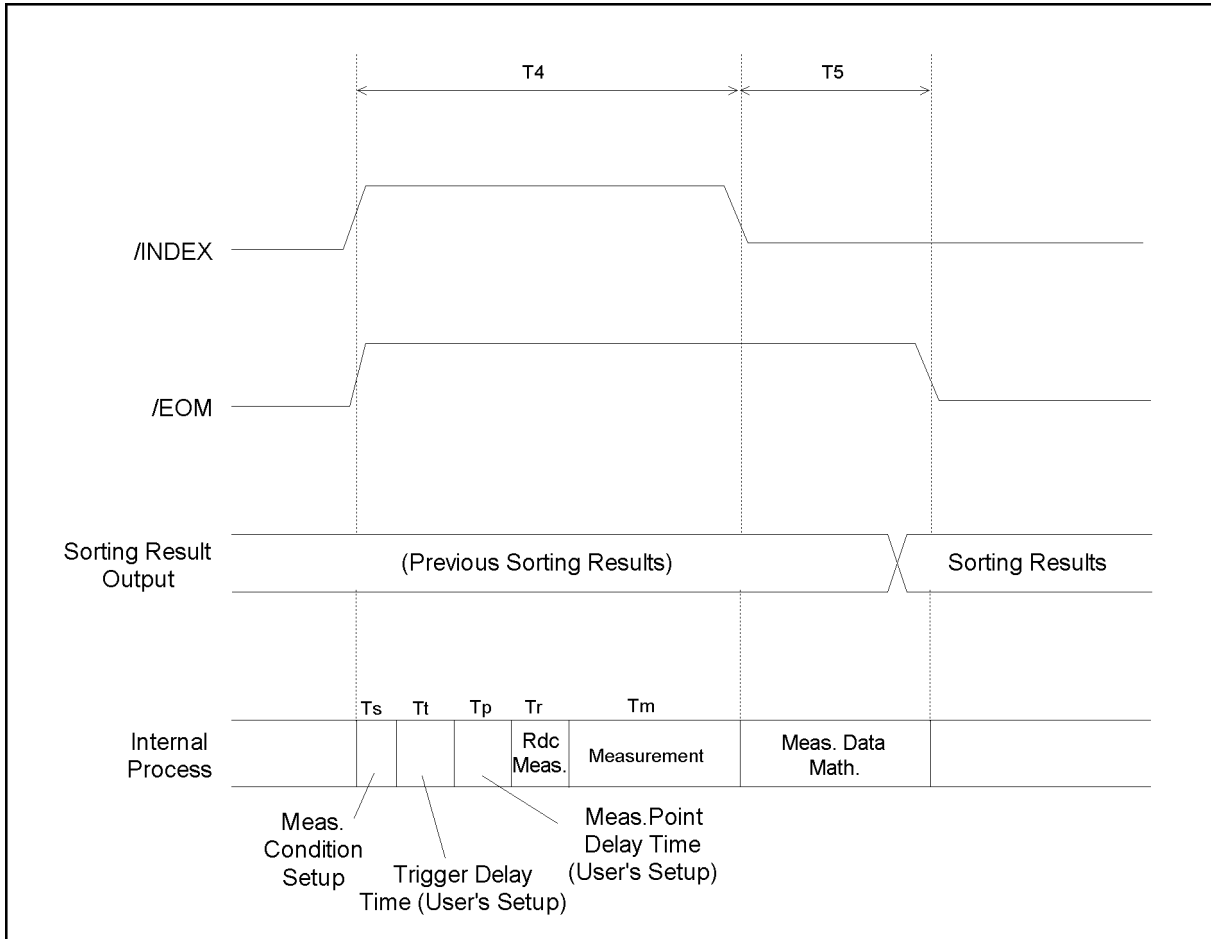

4287a0e157

Figure 12-6 Measurement Time T4 at List Measurement

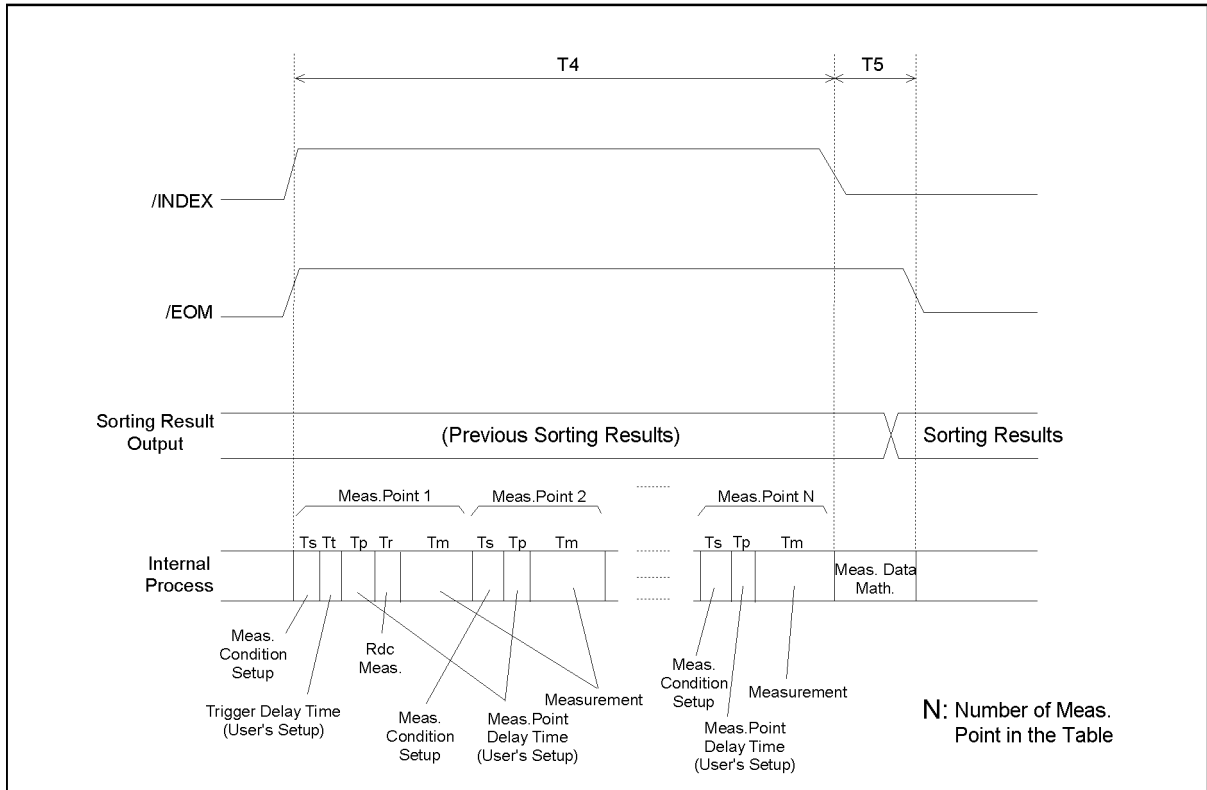

4287ace158

12. Specifications and Supplemental Performance Characteristics

Table 12-2 Values of Ts, Tt, Tp, Tr and Tm (Typical)

		Time [ms]
Ts	Measurement condition setup time	<ul style="list-style-type: none"> •If the test signal level has changed^{*1} crossing -12.95 dBm or -22.95 dBm since the last measurement cycle: 300 ms •If the test signal level has changed^{*2} without crossing -12.95 dBm or -22.95 dBm or if there is no level change in the test signal: see table below.
Tt	Trigger delay time	0.0 ms to 1000.0 ms ^{*3}
Tp	Measurement point delay time	0.0 ms to 1000.0 ms ^{*4}
Tr	Rdc measurement time	2.0 ms ^{*5}
Tm	Measurement data acquirement time	6.9 ms ^{*6}

- *1. For example, this can be a level change from -15 dBm to -10 dBm.
- *2. For example, this can be a level change from -20 dBm to -15 dBm.
- *3. To set this, use the :TRIG:DEL command.
- *4. To set this, use the :TRIG:SEQ2:DEL command.
- *5. This applies when the offset cancel function is turned off. Add 2 [ms] when the offset cancel function is turned on.
- *6. This applies when the averaging factor is 1. Add 3.9 [ms] for every increase of the averaging factor by 1.

NOTE

Time settings Ts, Tt, Tp, Tr and Tm indicated in Table 12-2 are the values taken when the instrument makes a measurement without receiving any external request (such as user actions through the front panel keys, keyboard, or mouse) and without performing non-measurement tasks (such as printout and network connection handling) while the measurement results display is off.

Table 12-3 Values of Ts (Typical)

Change in test signal frequency since last measurement cycle		Ts [ms]
No change		0
Increase	Change in frequency crossing 1.73995 GHz ^{*1}	$3.4 + 1 \times (f - fp) / 1E9$ ^{*2}
	Change in frequency without crossing 1.73995 GHz ^{*3}	$1 \times (f - fp) / 1E9$ ^{*2}
Decrease	Change in frequency crossing 1.73995 GHz ^{*4}	$1.7 + 2 \times (fp - f) / 1E9$ ^{*2}
	Change in frequency without crossing 1.73995 GHz ^{*5}	$2 \times (fp - f) / 1E9$ ^{*2}

- *1. For example, this can be a frequency change from 1.7 GHz to 1.8 GHz.
- *2. f: Test signal frequency [Hz] currently in effect, fp: Test signal frequency [Hz] in the last measurement
- *3. For example, this can be a frequency change from 1.8 GHz to 1.9 GHz.
- *4. For example, this can be a frequency change from 1.8 GHz to 1.7 GHz.
- *5. For example, this can be a frequency change from 1.7 GHz to 1.6 GHz.

Single-point measurement (Typical)

This section provides an example of measurement time calculation based on the conditions shown in the table below.

Measurement point settings	Test signal frequency	100 MHz
	Test signal level	0 dBm
	Averaging factor	2
Trigger delay time		3.0 ms
Measurement point delay time		0 ms
R _{dc} measurement		Off

Here, Ts, Tt, Tp, Tr, Tm are as follows:

$$T_s = 0 \text{ ms}$$

$$T_t = 3.0 \text{ ms}$$

$$T_p = 0 \text{ ms}$$

$$T_r = 0 \text{ ms (R}_{dc} \text{ measurement off)}$$

NOTE

When measurement cycles are repeated at the single point, Ts is normally 0 ms because the test signal settings do not change. However, Ts may not be 0 ms if you start a new measurement cycle with the measurement conditions shown in the table above immediately after performing measurement with different conditions.

$$T_m = 6.9 + 3.9 = 10.8 \text{ ms (averaging factor: 2)}$$

The measurement time would be $0 + 3.0 + 0 + 0 + 10.8 = 13.8 \text{ ms}$ based on these conditions.

List measurement (Typical)

This section provides an example of measurement time calculation for one cycle of list measurement based on the conditions shown in the table below.

Measurement condition table settings (with two measurement points defined)	Point 1	Test signal frequency	100 MHz
		Test signal level	0 dBm
		Averaging factor	2
	Point 2	Test signal frequency	800 MHz
		Test signal level	0 dBm
		Averaging factor	1
Trigger delay time			2.0 ms
Measurement point delay time			1.0 ms
R _{dc} measurement			On (the offset cancel function is off)

For Tt, Tp and Tr, these settings are applied regardless of the measurement point settings:

Specifications and Supplemental Performance Characteristics

Basic Measurement Characteristics

$T_t = 2.0$ ms; $T_p = 1.0$ ms; $T_r = 2.0$ ms (R_{dc} measurement on).

- T_s and T_m at point 1

Between point 2 (previous conditions) and point 1, the test signal changes in frequency from 800 MHz to 100 MHz but does not change in level. Thus, T_s is determined as follows:

$$T_s = 2 \times (0.8E9 - 0.1E9) / 1E9 = 1.4 \text{ ms}$$

The averaging factor is 2 for the point. This determines T_m as follows:

$$T_m = 6.9 + 3.9 = 10.8 \text{ ms}$$

- T_s and T_m at point 2

Between point 1 and point 2, the test signal changes in frequency from 100 MHz to 800 MHz but does not change in level. Thus, T_s is determined as follows:

$$T_s = 1 \times (0.8E9 - 0.1E9) / 1E9 = 0.7 \text{ ms}$$

The averaging factor is 1 for the point. This determines T_m as follows:

$$T_m = 6.9 \text{ ms}$$

Thus, the measurement time is determined as follows:

$$T_s \text{ (at point 1)} + T_t + T_p + T_r + T_m \text{ (at point 1)} + T_s \text{ (at point 2)} + T_p + T_m \text{ (at point 2)} = 1.4 + 2.0 + 1.0 + 2.0 + 10.8 + 0.7 + 1.0 + 6.9 = 25.8 \text{ ms}$$

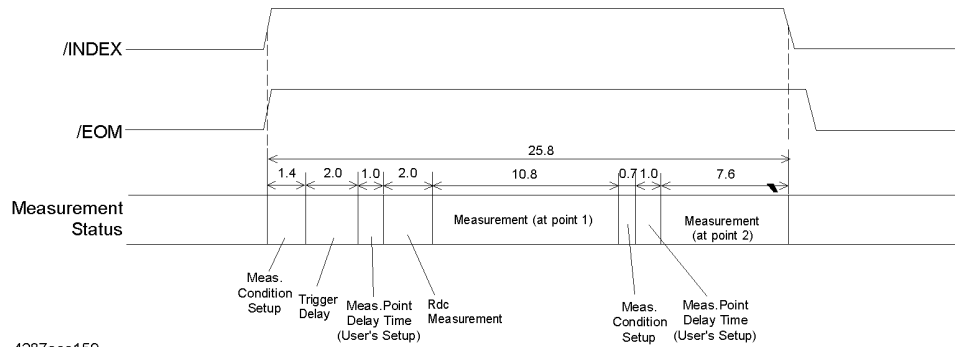

Measurement Data Transfer Time through GPIB (Typical)

Conditions:

4287A: S/N JP1KGxxxxx
 Host computer: HP9000 Series, Model 715
 Display: OFF
 Measurement mode: List measurement
 Measurement parameters: Ls and Q
 Evaluation method: Average value of 10,000 repeated measurements

Table 12-4

Measurement Data Transfer Time through GPIB (Typical)

Number of measurement points	Required time for FETCH? command	
	Rdc measurement OFF	Rdc measurement ON
1	10.0 ms	10.0 ms
2	12.0 ms	13.5 ms
3	15.0 ms	15.0 ms

Switching Time for Setup Change by GPIB (Typical)

Conditions:

Host computer: HP9000 Series, Model 715
 Display: OFF
 Measurement mode: List measurement
 Measurement parameters: Ls and Q
 Evaluation method: Average value of 10,000 repeated measurements

Table 12-5

Switching Time for Setup Change by GPIB (Typical)

Conditions	Time
Measurement table switching at list measurement (required time for executing :SOUR:LIST:TABLE 1 command and *OPC? command)	8.8 ms

Measurement Support Functions

Error correction function

Available Calibration and Compensation

OPEN/SHORT/LOAD Calibration	Connect OPEN, SHORT, and LOAD standards to the desired reference plane and measure each kind of calibration data. The reference plane is called the calibration reference plane.
Low-Loss Capacitor Calibration	Connect the dedicated standard (Low-Loss Capacitor) to the calibration reference plane and measure the calibration data.
Port Extension Compensation (Fixture Selection)	When a device is connected to a terminal that is extended from the calibration reference plane, set the electrical length between the calibration plane and the device contact. Select the model number of the registered test fixtures in the 4287A's softkey menu or enter the electrical length for the user's test fixture.
OPEN/SHORT Compensation	When a device is connected to a terminal that is extended from the calibration reference plane, make OPEN and SHORT states at the device contact and measure each kind of compensation data.

Calibration/Compensation Data Measurement Point

Data Measurement Points	Same as measurement points set in the measurement point setup display. (Changing the frequency or oscillator level settings after calibration or compensation makes the calibration and compensation data invalid.)
-------------------------	---

DC resistance (R_{dc}) measurement

Measurement range	0.1 Ω to 100 Ω
Measurement resolution	1 mΩ
Test signal level	1 mA (maximum)
Error correction	OPEN/SHORT/LOAD Calibration, OPEN/SHORT Compensation. (Changing the frequency or oscillator level settings after the calibration or compensation makes the calibration and compensation data invalid.)
Measurement uncertainty	$\pm \left[1 + \left(\frac{0.05}{R_{dut}} + \frac{R_{dut}}{10000} \right) \times 100 \right] \text{ [%]}$ <p>R_{dut}: DC resistance measurement value [Ω] Within ±5°C from the calibration temperature. Measurement accuracy applies when the calibration is performed at 23°C ±5°C. When the calibration is performed beyond 23°C ±5°C, the measurement accuracy decreases to half that described.</p>

Trigger function

Trigger mode	Internal, External (external trigger input connector or handler interface), Bus (GPIB or LAN), Manual (front key)
--------------	---

Averaging function

Setting range	1 to 100 (integer)
---------------	--------------------

Display

Type/Size	Color LCD, 8.4 inch
Resolution	640 dots × 480 lines

List measurement function

Number of Measurement points	32 points for each table (maximum)
Number of tables	8 tables

Test signal level monitor function

Uncertainty of monitor value	$\pm \left[30 + \left(10^{\frac{A}{20}} - 1 \right) \times 100 + B \right] [\%](SPC)$ <p>A: Uncertainty of oscillator level [dB] B: Uncertainty of impedance measurement [%]</p>
------------------------------	--

Mass Storage

Built-in flexible disk drive	3.5 inch, 720 KByte or 1.44 KByte, DOS format
Built-in hard disk drive	About 18 GByte

Interface

GPIB

Standard conformity	IEEE 488.1-1987, IEEE 488.2-1987
Available functions (function code)*1	SH1, AH1, T6, TE0, L4, LE0, SR1, RL0, PP0, DT1, DC1, C0, E2
Numerical data transfer format	ASCII
Protocol	IEEE 488.2-1987

*1. Refer to the standard for the meaning of each function code.

Handler Interface

Connector type	36 pin centronics connector
Signal type	Negative logic, Opto-isolated, Open collector output
Output signal	<ul style="list-style-type: none"> • BIN sort result (BIN 1 to BIN 13, OUT_OF_GOOD_BINS) • DC resistance pass/fail (DCR_OUT_OF_RANGE) • Overload (OVL D) • Alarm (ALARM) • End of analog measurement (INDEX) • End of measurement (EOM) • Ready for trigger (READY_FOR_TRIG)
Input signal	<ul style="list-style-type: none"> • External trigger (EXT_TRIG) • Key lock (KEY_LOCK)
Pin locations	See Figure 12-7. Refer to Programming Manual for the definition of each pin.

Figure 12-7 Pin Locations of Handler Interface

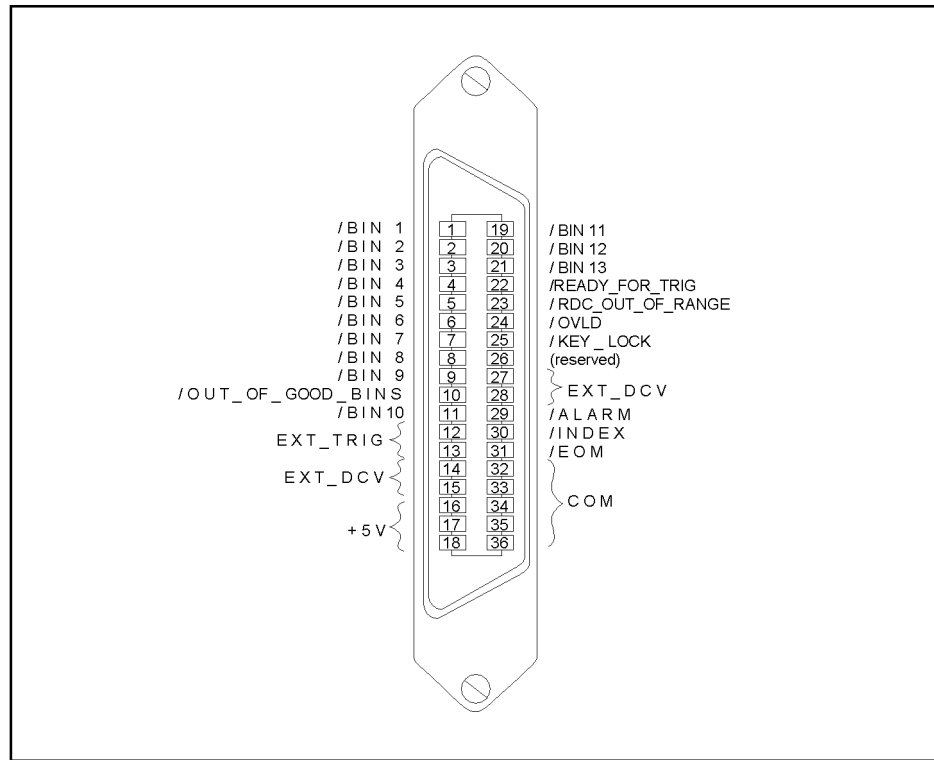

4287apj008

LAN Interface

Standard conformity	10 Base-T or 100 Base-TX (automatically switched), Ethertwist, RJ45 connector
Protocol	TCP/IP
Functions	Telnet, FTP

Measurement terminal (at Test Head)

Connector type	3.5-mm (female) connector (can be converted to 7-mm connector using the 3.5-mm-to-7-mm adapter)
----------------	--

Rear panel connectors

External Reference Signal Input Connector

Frequency	10 MHz \pm 10 ppm (SPC)
Level	\geq 0 dBm (SPC)
Input impedance	50 Ω (nominal)
Connector type	BNC (female)

Internal Reference Signal Output Connector

Frequency	10 MHz (nominal)
Uncertainty of frequency	Same as frequency uncertainty described in "Source characteristics" on page 253
Level	+2 dBm (nominal)
Output impedance	50 Ω (nominal)
Connector type	BNC (female)

External Trigger Input Connector

Level	LOW threshold voltage: 0.5 V HIGH threshold voltage: 2.1 V Input level range: 0 to +5 V
Pulse width (Tp)	\geq 2 μ sec (SPC) See Figure 12-8 for definition of Tp
Polarity	Positive or Negative (selective)
Connector type	BNC (female)

Figure 12-8

Definition of Pulse Width (T_p)

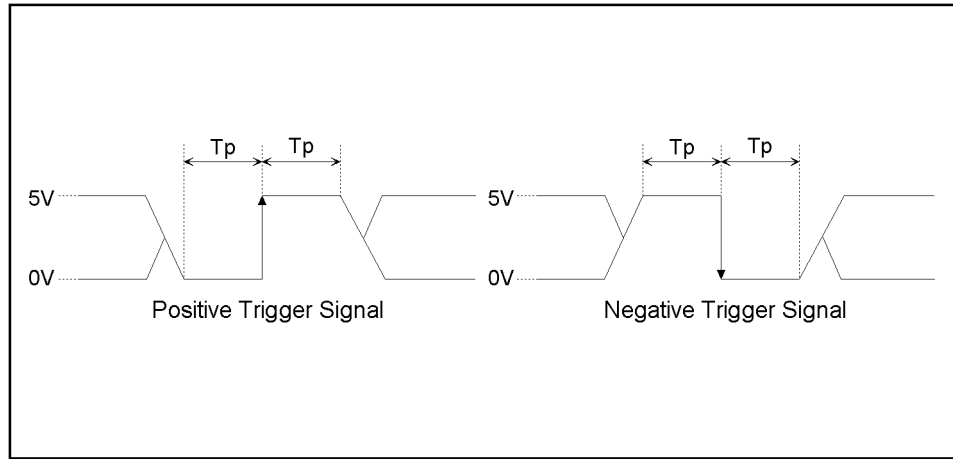

C5010014e

NOTE

An USB and a parallel printer inteaface are not supported.

General Characteristics

Environment conditions

Operating Condition





Temperature	5 °C to 40 °C
Humidity (at wet bulb temperature ≤ 29 °C, without condensation)	
Flexible disk drive non-operating condition	20 % to 80 % RH
Flexible disk drive operating condition	15 % to 90 % RH
Altitude	0 to 2,000 m (0 to 6,561 feet)
Vibration	0.5 G maximum, 5 Hz to 500 Hz
Warm-up time	30 minutes

Non-Operating Storage Condition

Temperature	- 20°C to + 60°C
Humidity (at wet bulb temperature ≤ 45 °C, without condensation)	15% to 90% RH
Altitude	0 to 4,572 m (0 to 15,000 feet)
Vibration	1 G maximum, 5 Hz to 500 Hz

Specifications and Supplemental Performance Characteristics
General Characteristics

Other Specifications

<p>EMC</p>  ISM 1-A	<p>European Council Directive 89/336/EEC IEC 61326-1:1997+A1 CISPR 11:1990 / EN 55011:1991 Group 1, Class A IEC 61000-4-2:1995 / EN 61000-4-2:1995 4 kV CD / 8 kV AD IEC 61000-4-3:1995 / EN 61000-4-3:1996 3 V/m, 27-1000 MHz, 80% AM IEC 61000-4-4:1995 / EN 61000-4-4:1995 1 kV power / 0.5 kV Signal IEC 61000-4-5:1995 / EN 61000-4-5:1995 0.5 kV Normal / 1 kV Common IEC 61000-4-6:1996 / EN 61000-4-6:1996 3 V, 0.15-80 MHz, 80% AM IEC 61000-4-11:1994 / EN 61000-4-11:1994 100% 1cycle NOTE 1: When tested at 3 V/m according to EN 61000-4-3:1996, the measurement accuracy will be within specifications over the full immunity test frequency range of 27 to 1000 MHz except when the analyzer frequency is identical to the transmitted interference signal test frequency. NOTE 2: When tested at 3 V according to EN 61000-4-6:1996, the measurement accuracy will be within specifications over the full immunity test frequency range of 0.15 to 80 MHz except when the analyzer frequency is identical to the transmitted interference signal test frequency. This ISM device complies with Canadian ICES-001. Cet appareil ISM est conforme à la norme NMB-001 du Canada.</p>  N10149
<p>Safety</p>  ISM 1-A	<p>European Council Directive 73/23/EEC IEC 61010-1:1990+A1+A2 / EN 61010-1:1993+A2 INSTALLATION CATEGORY II, POLLUTION DEGREE 2 INDOOR USE IEC60825-1:1994 CLASS 1 LED PRODUCT</p>  LR95111C

<p>Environment</p> 	<p>This product complies with the WEEE Directive (2002/96/EC) marking requirements. The affixed label indicates that you must not discard this electrical/ electronic product in domestic household waste.</p> <p>Product Category : With reference to the equipment types in the WEEE Directive Annex I, this product is classed as a “Monitoring and Control instrumentation” product.</p> <p>Do not dispose in domestic household waste.</p> <p>To return unwanted products, contact your local Agilent office, or see www.agilent.com/environment/product/ for more information.</p>
<p>Power requirements</p>	<p>90 V to 132 V, or 198 V to 264 V (automatically switched), 47 Hz to 63 Hz, 350 VA max.</p>
<p>Weight</p>	
<p>Main unit</p>	<p>16 kg (SPC)</p>
<p>Test head</p>	<p>0.3 kg (SPC)</p>
<p>Dimensions</p>	
<p>Main unit</p>	<p>See Figure 12-9 through Figure 12-11.</p>
<p>Test head</p>	<p>See Figure 12-12.</p>

Figure 12-9 Main Unit Dimensions (front view, in millimeters, typical)



4287aoj146

Figure 12-10 Main Unit Dimensions (rear view, in millimeters, typical)

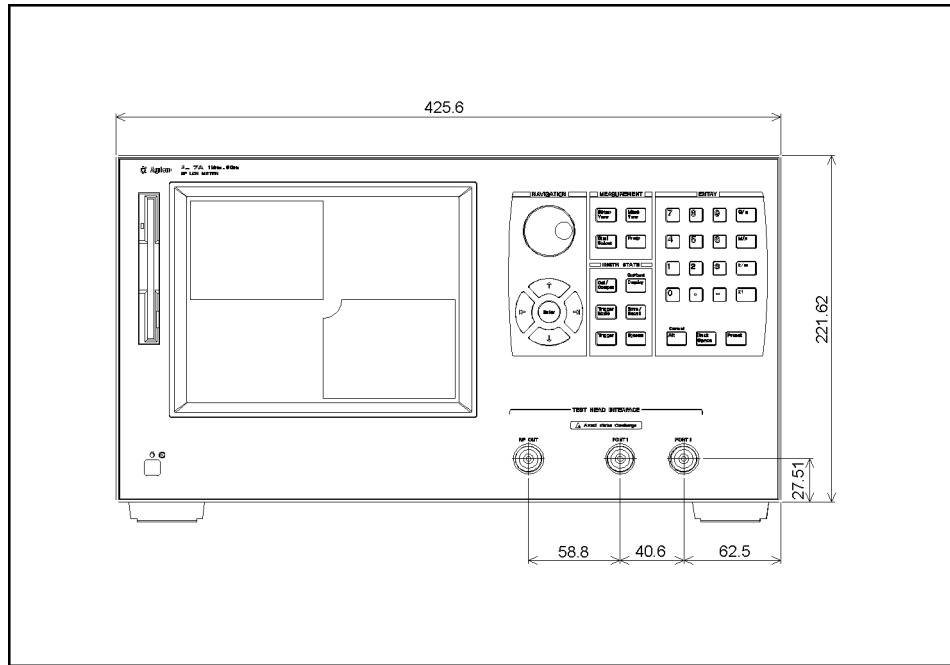
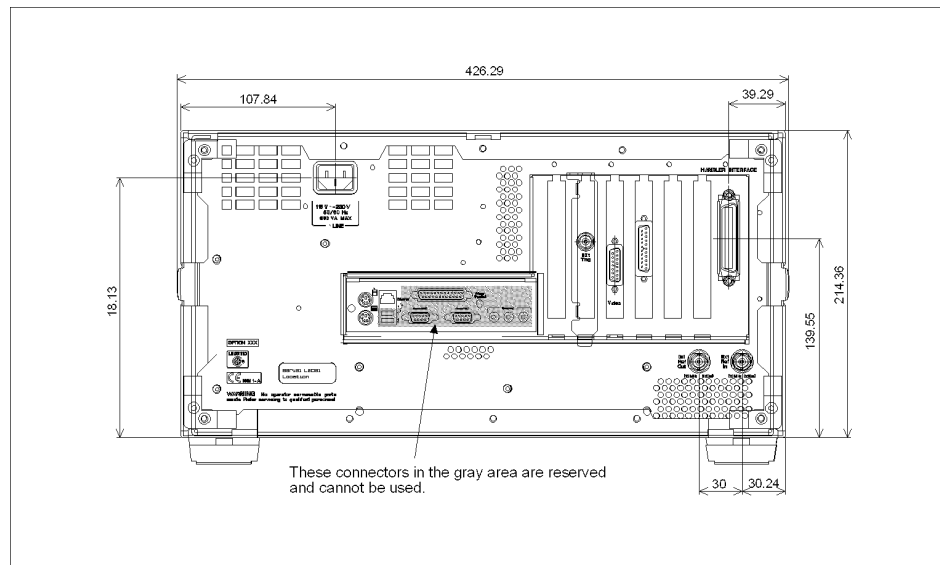

4287aoj10006

Figure 12-11 Main Unit Dimensions (side view, in millimeters, typical)

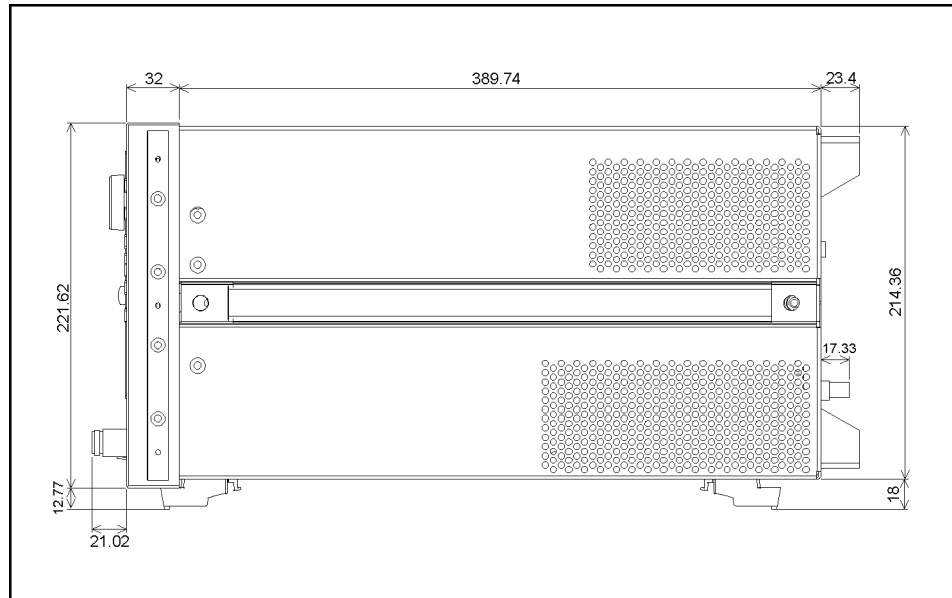

4287aoj148

Figure 12-12 Test Head Dimensions (in millimeters, typical)

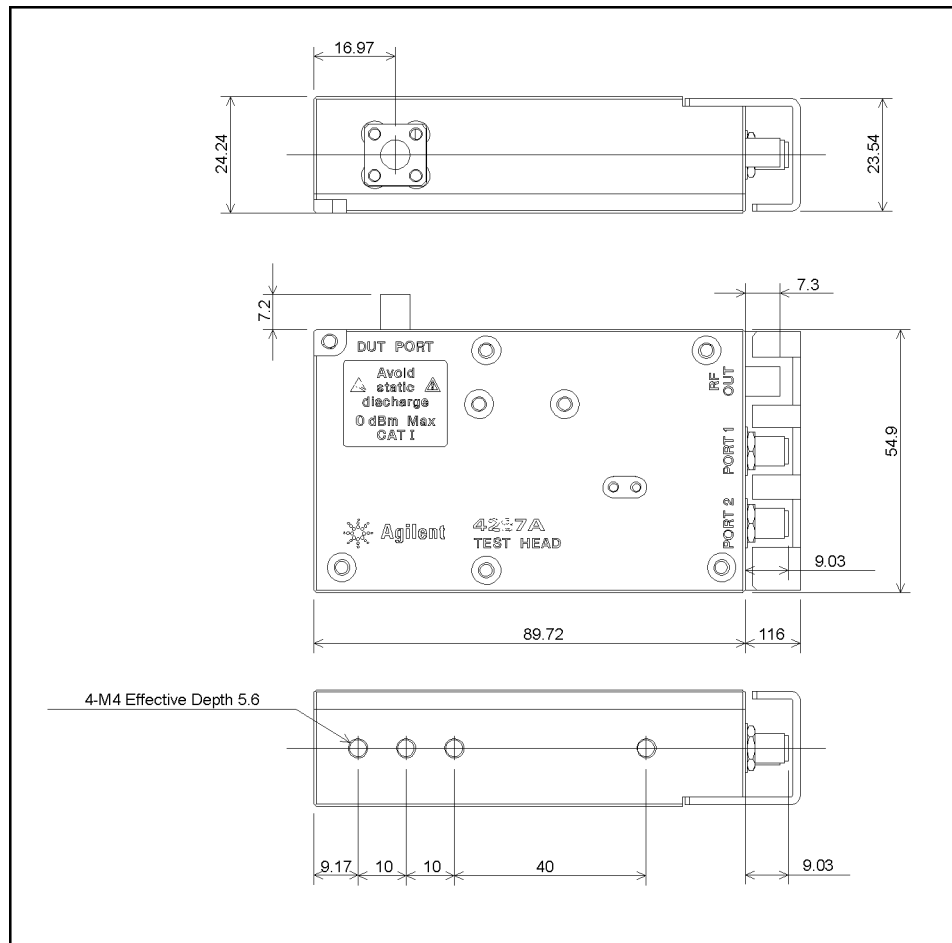

4287aoe149

12. Specifications and Supplemental Performance Characteristics

Specifications and Supplemental Performance Characteristics
General Characteristics

Furnished accessories

Order Model or Option Number	Agilent Part Number	Description	Qty	Check (✓)
Agilent 4287A	-	Agilent 4287A RF LCR Meter (Main Unit)	1	
	-	Test Head (with 1 m cable)	1	
	1250-2879	N(m)-SMA(f) Adapter	3	
	8710-2409	Wrench (for 3.5-mm/SMA connector)	1	
	04287-905xx	CD-ROM (<i>Operation Manual, Programming Manual, Sample Program</i>)* ¹	1	
	E2078-62101	GPIB adapter* ²	1	
	-	Power Cable	1	
Option 700	-	Agilent 16195B 7-mm Calibration Kit	1	
Option 710	-	Test Fixture Stand	1	
Option 720	1250-1746	3.5-mm-to-7-mm Coaxial Adapter	1	
Option 810	-	Keyboard	1	
Option 820	-	Mouse	1	
Option ABA	04287-900x0	<i>Operation Manual</i> * ¹	1	
	04287-900x1	<i>Programming Manual</i> * ¹	1	
	04287-180x0	Sample Program Disk (3.5 inch floppy disk)* ¹	1	
Option 004	16197-29001	Short device 0.6 × 0.3 mm	2	
	16191-29005	Short device 1.0 × 0.5 mm	2	
	16191-29006	Short device 1.6 × 0.8 mm	2	
	16191-29007	Short device 2.0 × 1.25 mm	2	
	16191-29008	Short device 3.2 × 1.6 mm	2	
	0699-6926	Resistor 0.6 × 0.3 mm	5	
	5182-0433	Resistor 1.0 × 0.5 mm	5	
	5182-0434	Resistor 1.6 × 0.8 mm	5	
	5182-0435	Resistor 2.0 × 1.25 mm	5	
	5182-0436	Resistor 3.2 × 1.6 mm	5	
Option 020	-	Test Head Extension Cable (1 m)	1	
	1250-1158	SMA(f)–SMA(f) Adapter	3	
Option 1CM	5063-9216	Rackmount Kit	1	
Option 1CN	5063-9229	Handle Kit	1	
Option 1CP	5063-9223	Rackmount & Handle Kit	1	

*1. The number indicated by “x” in the part number of each manual or sample program disk, 0 for the first edition, is incremented by 1 each time a revision is made. The latest edition comes with the product.

*2. Use this adapter when to connect a GPIB cable to 4287A GPIB connector.

Option 004 Working Standard Set Characteristics

Furnished devices

Short device	0.6 × 0.3 mm (part number: 16197-29001) 1.0 × 0.5 mm (part number: 16191-29005) 1.6 × 0.8 mm (part number: 16191-29006) 2.0 × 1.25 mm (part number: 16191-29007) 3.2 × 1.6 mm (part number: 16191-29008)
Resistor	0.6 × 0.3 mm (part number: 0699-6926) 1.0 × 0.5 mm (part number: 5182-0433) 1.6 × 0.8 mm (part number: 5182-0434) 2.0 × 1.25 mm (part number: 5182-0435) 3.2 × 1.6 mm (part number: 5182-0436)

DC resistance

Resistor	51 Ω \pm 0.5%
----------	------------------------

Specifications and Supplemental Performance Characteristics
Option 004 Working Standard Set Characteristics

A **Manual Changes**

This appendix contains the information required to adapt this manual to versions or configurations of the 4287A manufactured earlier than the current printing date of this manual. The information in this manual applies directly to 4287A units with the serial number that is printed on the title page of this manual.

Manual Changes

To adapt this manual to your 4287A, refer to Table A-1 and Table A-2.

Table A-1 Manual Changes by Serial Number

Serial Number Prefix	Make Manual Changes
JP1KG	“Change 3”
JP1KG , M432	“Change 4”“Change 5”“Change 6”

Table A-2 Manual Changes by Firmware Version

Version	Make Manual Changes
1.1x	“Change 1”, “Change 2”
1.20	“Change 2”
2.0x	“Change 4”“Change 5”“Change 6”“Change 7”

Agilent Technologies uses a two-part, ten-character serial number that is stamped on the serial number plate (Figure A-1). The first five characters are the serial prefix and the last five digits are the suffix.

Figure A-1 Example of Serial Number Plate



4287aaj1101

Change 7

This function is available when the volume label on the C-drive is IZ202 or higher.

- User recovery function

Change 6

“System Recovery” can not be applied. Reffer to the following explation.

System recovery

NOTE

The 4287A with option 011 can not operate this function.

Performing system recovery will allow you to reset the Windows operating system and the firmware of the 4287A to the state when you purchased^{*1}.

If, for some reason, the Windows operating system or firmware failed and cannot be started normally or operation after startup is unstable, execute system recovery.

Notes on executing system recovery

Performing system recovery causes the following:

- The following settings of the 4287A are initialized.
 - Network settings
 - GPIB settings
 - Printer settings
- If the firmware has been updated after purchasing the 4287A, the firmware when you purchased the product^{*1} is recovered.

Files you created using the save function are not affected, but we recommend backing them up before executing system recovery for precautionary purposes.

Procedure to execute system recovery

NOTE

You need the keyboard for this operation.

Step 1. Shut down the 4287A.

Step 2. Connect the keyboard to the 4287A.

Step 3. Press the standby switch of the 4287A to turn it on.

Step 4. When the message in the figure below appears on the screen following the Agilent's logo

^{*1}.If the hard disk failed and has been replaced after purchase, the state when the replacement was performed is recovered.

Manual Changes

Manual Changes

screen, immediately press **R** on the keyboard.

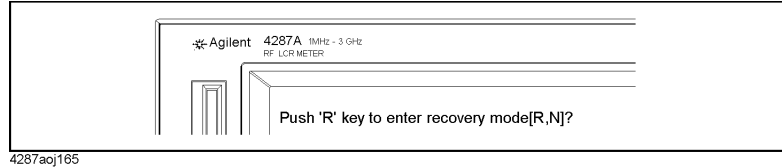

NOTE

Watch the message carefully because after several seconds it will be replaced with the next screen. Note that this is automatically done with no key operations.

If the above message does not appear, the 4287A is at fault; contact your local Agilent customer center listed at the end of this manual or the distributor from which you purchased the instrument.

Step 5. When "Recover Hard disk (C drive) [Y, N]?" is displayed, press **Y** on the keyboard. If you want to quit the system recovery, press **N** to start up the 4287A as usual.

Step 6. The following message appears. This is the final confirmation message asking whether you want to start the system recover. Press **Y** on the keyboard to start the system recovery. If you want to quit the system recovery, press **N** to start up the 4287A as usual.

```
=====
SYSTEM RECOVERY
=====
```

This process will recover the system drive (C:) of this instrument to the factory-shipment state. It takes about 10 minutes. Please refer to the Operation Manual for more information.

This is the last chance to quit the recovery process

Continue [Y,N]?

Step 7. The system recovery will complete in about 10 minutes. The following message is displayed during the system recovery.

```
=====
SYSTEM RECOVERY IN PROGRESS....
=====
```

System recovery in progress. It takes about 10 minutes. Please DO NOT TURN THE POWER OFF DURING THIS TIME.

CAUTION

Never turn off the power during the system recovery because doing so may cause serious damage to the 4287A.

Step 8. When the system recovery is completed, the following message appears below the above message indicating that the system recovery is in progress.

```
"Recovery Completed !"
"Please any key and then restart system."
```

Now the system recovery of the 4287A is complete.

NOTE

If the problem persists even after executing system recovery, the 4287A is at fault; contact your local Agilent customer center listed at the end of this manual or the distributor from which you purchased the instrument.

Change 5

“Configuring the network” can not be applied. Reffer to the following explation.

Checking and Editing the LAN Settings

The following explains how to set the necessary addresses and other settings required for using the LAN (Local Area Network) functions of the 4287A. For details on LAN functions, see the *Programming Manual*.

Checking and editing the network addresses

The 4287A network addresses (IP address, Gateway address, Sub Net Mask) can be checked and edited by the following procedure (IP: Internet Protocol).

NOTE

For how to perform the instruction “press the key (softkey) in the softkey menu” mentioned in the procedure, see “13. Softkeys” on page 87.



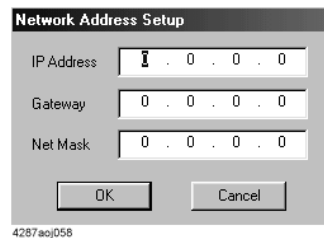

- Step 1.** Press the **[System]** key on the front panel to display the System softkey menu.
- Step 2.** Press the **LAN SETUP** key in the softkey menu to display the LAN SETUP softkey menu.
- Step 3.** Press the **SETUP IP ADDRESS** key in the softkey menu to display the Network Address Setup dialog box (Figure A-2).

Figure A-2

Network Address Setup dialog box



- Step 4.** Perform the following operations to enter the IP address, Gateway address and Net Mask address in their respective input boxes of the dialog box.

Function	Operation		
	Front panel	Keyboard	Mouse
Moving the cursor	Turn  , or press     .	Press [Tab][↑][↓][←][→] .	Click the position where the cursor should be moved to. ^{*1}

A. Manual Changes





Manual Changes
Manual Changes

Function	Operation		
	Front panel	Keyboard	Mouse
Deleting the character to the left of the cursor	Press [Back Space] .	Press [←Backspace].	(Not possible)
Deleting the character to the right of the cursor	(Not possible)	Press [Delete] .	(Not possible)
Entering a digit at the position of the cursor	Press [0][1][2] ... [9] .	Press [0][1][2] ... [9] .	(Not possible)

*1. However, if the **OK** or **Cancel** button is clicked, you will execute Step 5 rather than move the cursor.

NOTE Each of the network addresses can be set using whole numbers from 0 to 255, separated by periods (.).

Step 5. Use the following operations to complete or cancel the input.

Function	Operation		
	Front panel	Keyboard	Mouse
To accept the input (execute)	Move the cursor in the dialog box to the OK button and then press [×1],  , or  .	Press [Enter] .	Click the OK button in the dialog box.
To cancel the input	Press [Cancel] *1, or move the cursor in the dialog box to the Cancel button and then press [×1],  , or  .	Press [Esc] .	Click the Cancel button in the dialog box.

*1. Same as the **[Alt]** key.

Change 4

“Setting the internal Clack” can not be applied. Reffer to the following explation.

Setting the Internal Clock

The 4287A is equipped with an internal clock with clock/date function. The internal clock is used for recording the date and time when data are stored on a storage device, etc. The following procedure can be used to set the date and time of the internal clock of the 4287A.

NOTE Be sure to set the internal clock the first time the power is turned ON after you receive the instrument.

Follow these steps to set the clock by using only the keys on the front panel, i.e., without using a keyboard or mouse.

1. Displaying the Setting Date and Time dialog box









- Step 1.** Press the **[Preset]** key on the front panel to place the 4287A in the mode for presetting the clock.
- Step 2.** Press the **[System]** key on the front panel to display the System softkey menu.
- Step 3.** Press the  key or  key on the front panel the required number of times to move the cursor in the softkey label area in the right side of the screen to the **SET DATE & TIME** key.
- Step 4.** Press the  key on the front panel.
The Setting Date and Time dialog box (Figure A-3) appears.

Figure A-3

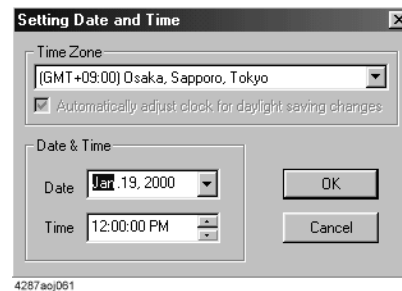
Setting Date and Time dialog box



2. Selecting the time zone and setting the automatic daylight saving time adjustment

- Step 1.** Press the  key or  key on the front panel the required number of times to move the cursor in the dialog box to the Time Zone box.
- Step 2.** Press the  key or  key on the front panel the required number of times to select the time zone.
- Step 3.** Press the  key on the front panel once.

If an area where daylight saving time is implemented was selected in Step 2, the cursor moves to the “Automatically adjust clock for daylight saving changes” setting area. In this case, perform the following steps to execute the setting for automatic adjustment for daylight saving time before proceeding to “3. Setting the date”.

- a. Press the  key on the front panel to switch the function for automatic adjustment for daylight saving time ON or OFF (the setting toggles with each press of the button).

Check box	Automatic adjustment for daylight saving time
√	On
{blank field}	Off

- b. Press the  key on the front panel once to move the cursor to the Date box.



When an area where daylight saving time is not implemented was selected in Step 2, the cursor moves to the Date box, proceeding to “3. Setting the date”.

3. Setting the date

Step 1. Press the [.] key on the front panel the required number of times to move the cursor to the position where the “month” is indicated.

NOTE

Each press on the [.] key moves the cursor inside the Date box in the following order: Month → Day → Year → Month → ..

Step 2. Press the  key or  key on the front panel the required number of times to select the “month.”

Step 3. Press the [.] key on the front panel the required number of times to move the cursor to the position where the “day” is indicated.

Step 4. Use the number keys ([0][1] to [9]) on the front panel to enter the day.

Step 5. Press the [.] key on the front panel to move the cursor to the position where the “year” is indicated.

Step 6. Use the number keys ([0][1] to [9]) on the front panel to enter the year.

NOTE

When a mouse is used, click the down-arrow ▼ to the right of the Date box to display the date setting calendar (Figure A-4). Then click the appropriate date on the calendar to complete the entire setting of the date.

Figure A-4

Date setting calendar



4. Setting the time

Step 1. Press the  key on the front panel once to move the cursor to the Time box.

Step 2. Press the [.] key on the front panel the required number of times to move the cursor to the position where “hour” is indicated.

NOTE



Each press on the [.] key moves the cursor inside the Time box in the following order: Hour → Minute → Second → AM/PM → Hour→ ..

Step 3. Use the number keys ([0][1] to [9]) on the front panel to enter the “hour.”



Step 4. Press the [.] key on the front panel to move the cursor to the position where “minute” is indicated.

Step 5. Use the number keys ([0][1] to [9]) on the front panel to enter the “minute.”



Step 6. Press the [.] key on the front panel to move the cursor to the position where “second” is indicated.

- Step 7.** Use the number keys ([0][1] to [9]) on the front panel to enter the “second.”
- Step 8.** Press the [.] key on the front panel to move the cursor to the position where “AM/PM” is indicated.
- Step 9.** Press the  key or  key on the front panel to select “AM” or “PM.”

5. Completing the setting



- Step 1.** Press the  key on the front panel once to move the cursor to the **OK** button.
- Step 2.** Press the  key on the front panel to complete the date and time setting and close the dialog box.

NOTE

To cancel setting of the date and time, press the  key or the  key on the front panel to move the cursor inside the dialog box to the **Cancel** button and then press the  key. If the setting of the date and time is cancelled, the date and time set and valid before you started to make the new setting will remain in effect.

6. Turning the date and time display On or Off

The set date and time can be displayed in the date/time display area in the lower-right area of the measurement display.

- Step 1.** Press the **[Display]** key on the front panel to show the Display softkey menu.
- Step 2.** Turn the rotary knob () on the front panel to move the cursor in the softkey menu to the **DATE & TIME []** key.
- Step 3.** Press the rotary knob () to switch the date/time display ON or OFF (the setting toggles with each press of the button).

Softkey indicator	Date/time display status
DATE & TIME [LIVE]	Display on (constantly updated)
DATE & TIME [STAMP]	Display on (display not updated)
DATE & TIME [OFF]	Display off

Miscellaneous Changes

The option system of the 4287A has changed since May 2003. Apply the following changes.

New Option Number	Old Option Number	Remark
700 (Agilent 16195B 7-mm Calibration Kit)	-	*1
-	001 (Without Agilent 16195B 7-mm Calibration Kit)	

Manual Changes
Manual Changes

New Option Number	Old Option Number	Remark
710 (Test Fixture Stand)	-	*2
-	002 (Without Test Fixture Stand)	
720 (3.5-mm-to-7-mm Coaxial Adapter)	-	*3
-	003 (Without 3.5-mm-to-7-mm Adapter)	
810 (Mini DIN Keyboard)	-	*4
-	1A2 (Delete Mini DIN Keyboard)	
820 (Mouse)	-	*5
-	1CS (Without Mouse)	
same as the right number	004 (Add Working Standard Set)	
same as the right number	020 (Add Test Fixture Extension Cable Set)	
same as the right number and discontinued in Dec.2004	010 (Hard-Disk Drive Mass Storage)	
same as the right number and discontinued in Dec.2004	011 (Solid-State Mass Storage)	
same as the right number	1CN (Handle Kit)	
same as the right number	1CM (Rack Mount Kit)	
same as the right number	1CP (Rack Mount & Handle Kit)	
ABA (Add Manual set (English))	-	*6
-	ABA (Select Manual set (English))	*7
ABJ (Add Operation Manual set (Japanese))	-	*6
-	ABJ (Select Manual set (Japanese))	*7
same as the right number	0BW (Add Service Manual)	
-	0B1 (Delete Manual Sets)	*8
-	0B1 (Add Manual Sets)	

*1. In the previous option system, the 16195B 7-mm Calibration Kit comes as one of standard accessories. In the new option system, it will be attached only when you choose option 700.

*2. In the previous option system, the Test Fixture Stand comes as one of standard accessories. In the new option system, it will be attached only when you choose option 710.

*3. In the previous option system, the 3.5-mm-to-7-mm Coaxial Adapter comes as one of standard accessories. In the new option system, it will be attached only when you choose option 720.

*4. In the previous option system, the keyboard comes as one of standard accessories. In the new option system, it will be attached only when you choose option 810.

*5. In the previous option system, the mouse comes as one of standard accessories. In the new option system, it will be attached only when you choose option 820.

*6. In the previous system, the option number is used to choose the language of manual set (standard accessory). In the new option system, it is used to add manual set (optional accessory) of the language the customer desires.

*7. In the previous option system, the CD-ROM (Contained Operation Manual, Programming Manual, Sample Program) attached when you choose option ABA. In the new option system, it will be attached as a standard accessories.

*8. No selection of addition/deletion is required for the manual set because it is only available as an optional accessory in the new option system. When 2 or more sets are required, specify option ABA,ABJ * (number of required sets).

Change 3

The serial number prefix JP1KG does not support the system recovery function. Please delete the descriptions about this function in this manual.

Change 2

The firmware revision 1.1x, and 1.20 does not support the R_{dc} offset cancel function. Please delete the descriptions about this function in this manual.

Change 1

The firmware revision 1.1x does not support controlling the BIN count function using the front panel. Please delete the descriptions about this function in this manual.

Manual Changes
Manual Changes

B Differences from Agilent 4286A

This appendix contains information about the differences between the Agilent 4286A (RF LCR Meter) and the Agilent 4287A (this product).

1. Main Differences Between 4286A and 4287A

This section outlines the main differences between the 4286A and 4287A.

Outline of Differences in Calibration/Compensation

Change in concept

The concept of calibration/compensation for the 4286A is to make a calibration plane by calibration and remove the error component from the jig section located at the tip of the plane. However, some users found this procedure troublesome and followed it without proper calibration/compensation. To prevent this, the calibration/compensation procedure of the 4287A was simplified without degrading precision. The same precision as that of the 4286A is implemented by performing only OPEN/SHORT/LOAD calibration for the 4287A instead of the longer procedure for the 4286A (performing OPEN/SHORT/LOAD/LOW LOSS CAPACITOR calibration before OPEN/SHORT/LOAD calibration).

Changes in functions

Changes in LOAD compensation

- The 4286A is provided with LOAD compensation; the 4287A, based on the concept described above, is not provided with LOAD compensation.
- For the 4286A, only one reference value for LOAD calibration can be set for the entire frequency range; for the 4287A, the reference value for LOAD calibration can be set for each of the list sweep frequency points.
- For the 4286A, only two parameters of Ls-Rs and Ls-Q are available for the LOAD reference value; for the 4287A, three parameters of Ls-Rs, Ls-Q, and Cp-D are available.

Change in USER and FIXED POINT modes

- For the 4286A, two modes, USER and FIXED POINT, are available; for the 4287A, only USER mode is available. In addition, the interpolation mode is not available with the 4287A; therefore, calibration/compensation have to be performed again if the frequency setting needs to be changed.

Change in Rdc measurement

- For the 4286A, the compensation data used for Rdc measurement is obtained at the same time the data for ordinary calibration/compensation is obtained; for the 4287A, the compensation data for Rdc measurement can be obtained separately.

New functions added to the 4287A

- The Calibration Wizard function, not available with the 4286A, is available with the 4287A.
- The 4286A is not provided with a function that checks whether calibration/compensation has been completed correctly; for the 4287A, this determination can be made by checking the DCR measured value, provided that the Calibration Wizard is active.

CAUTION

For the 4287A calibration/compensation functions, refer to Chapter 6, “Calibration and Compensation.”

Outline of Differences in Comparator Handler I/F

Change in the comparator function

- For the 4286A, the following functions are available: BINSORTING (sorting data into BINO to BIN9 and OUT_OF_BINS for one frequency point) and Limit Test (making the Go-No Go decision), and both can be used together.
- For the 4287A, four sorting conditions are set to allow more complex sorting, and setting is enabled for up to 13 bins.

CAUTION

For the 4287A comparator function, refer to Chapter 8, “Sorting According to Measurement Results.”

Changes in the Handler I/F

- For the 4286A, either MODE1 or MODE2 signal pattern can be selected; for the 4287A, only one signal pattern is available because the comparator function was changed as above.
- Regarding the electrical characteristics of the handler I/F, for the 4286A, the maximum rated voltage output of the decision output signal is 24 V and the maximum rated voltage output of the control output signal is 15 V; for the 4287A, the maximum rated voltage output is 24 V for both signals.
- For the 4287A, the /READY_FOR_TRIG signal, not output on the 4286A, is output.

CAUTION

For the 4287A handler I/F function, refer to Chapter 12, “Connection with Automatic Machine (Use of Handler I/F)” in the *4287A Programming Manual*.

Other Important Differences

View on the display

- For the 4286A, only two measurement parameters can be shown; for the 4287A, up to four measurement parameters can be shown.
- For the 4286A, the parameter display mode cannot be turned ON/OFF; for the 4287A, it can be turned ON/OFF for each of the parameters.
- For the 4287A, when used with the GPIB, there is an UPDATE ON/OFF function that can be used to minimize the time needed to redraw the images on the screen display; however, there is still a trade-off between the ability to watch real-time results and measurement speed. For more on the UPDATE ON/OFF function, refer to the last section, “Turning ON/OFF Update the LCD Display View,” in Chapter 7, “Executing Measurements and Displaying Results.”
- The 4287A is provided with a statistical processing function and a LAN interface.

CAUTION

For the 4287A statistical processing function, refer to Chapter 9, “Obtaining Statistical Data on Measurement Results.” For the 4287A LAN interface, refer to Chapter 13, “Use of LAN” in the *Programming Manual*.

2. Differences Between 4286A and 4287A Hardware

This section lists the differences between the 4286A and 4287A hardware.

Table B-1 Measurement performance

	4287A	4286A
Frequency	1 MHz to 3 GHz, in 100 kHz steps Max 32 points by 8 boards	1 MHz to 3 GHz, in 10 kHz steps Max 10 points
Test signal level	For open system: 4.47 mV to 0.502 V at ≤ 1 GHz 4.47 mV to 0.447 V at > 1 GHz For short-circuited system: 0.0894 to 10 mA at ≤ 1 GHz 0.0894 to 8.94 mA at > 1 GHz	For open system: 10 mV to 1 V For short-circuited system: 0.2 to 20 mA
Resolution	0.1 dBm (also when voltage and/or current is set)	Refer to the specification.
Basic accuracy	$\pm 1\%$	$\pm 1\%$
Range of Z measurement	200 m Ω to 3 k Ω (at 1 MHz, accuracy $< 10\%$)	200 m Ω to 3 k Ω (at 1 MHz, accuracy $< 10\%$)
Test head	1 m added standard, 1 m added optionally (2 m in total) Right angle only 3.5 mm (male)	1 m added standard, 3 m added optionally Right/straight angle 3.5 mm (male)
Duration of measurement	9 ms/point	15 ms/point

Table B-2 Functions for manufacturing line

	4287A	4286A
DCR measurement	For contact error check, ON/OFF switchable Contact errors are checked during calibration.	For contact check, ON/OFF switchable Contact errors are NOT checked during calibration.
Scanner compensation	Scanner I/F not provided By Table switching, Cal setting is enabled for each of the channels (through GPIB).	Scanner I/F not provided With I-Basic, compensation is enabled for each of the channels.

2. Differences Between 4286A and 4287A Hardware

Table B-2 Functions for manufacturing line

	4287A	4286A
Provision for multi-frequency	Different load reference values can be entered for different frequencies.	One fixed load reference value
Comparator	Max 13 bins Bin setting is enabled by combination of four conditions. - Bin sorting is enabled at each point of multi-frequency - Secondary parameters can be bin-sorted simultaneously.	Max 9 bins (only one frequency) Go/No/Go decision for each list sweep point
Resume	Supported	Supported only for calibration/compensation data
Statistical processing	Supported	Not supported
GPIB	GPIB I/F equipped ASCII, binary data	GPIB I/F equipped ASCII, binary data
Measurement parameters	4 orthogonal coordinate parameters	2 orthogonal coordinate parameters

Table B-3 Calibration

	4287A	4286A
Calibration/compensation	O/S/L/LLC calibration O/S compensation Electrical length calibration Without frequency interpolation Read/write is enabled from an external PC	O/S/L/LLC calibration O/S/L compensation Electrical length calibration With frequency interpolation Read/write is enabled from an external PC
Compensation kit	16195B (provision for high frequency, Load, Low Loss C)	16195A

Table B-4 Other characteristics

	4287A	4286A
Data storage (user area)	About 18 GB HDD 1.44 MB FDD	256 kbyte SRAM 1.44MB FDD
Interface	GPIB, Handler I/F LAN (10Base-T): Telnet, FTP	GPIB, Handler I/F

2. Differences Between 4286A and 4287A Hardware**Table B-4 Other characteristics**

	4287A	4286A
Display	8.4", color	7", monochrome
Dimensions of body	426 (W) x 234 (H) x 426 (D)mm	426 (W) x 234 (H) x 537 (D)mm
Weight of body	20 kg	28 kg
Dimensions of test head	90 (W) x 24 (D) x 55 (H) mm (excluding protrusions)	110 (W) x 28 (D) x 55 (H) mm (excluding protrusions)

3. Functional Differences Between 4286A and 4287A

This section describes the functional differences between the 4286A and 4287A based on the 4286A soft key tree. In the following table, each check mark (√) shows that the function is provided.

Table B-5 Measurement functions

Function			4286A	4287A	Remarks
Meas	Measurement parameter	Select Ls-Q	√	√	For one-point measurement with the 4287A, a maximum of four measurement parameters are randomly selected for simultaneous display.
		Select Ls-D	√	√	
		Select Ls-Rs	√	√	
		Select Lp-Q	√	√	
		Select Lp-D	√	√	
		Select Lp-G	√	√	
		Select Lp-Rp	√	√	
		Select Cs-Q	√	√	
		Select Cs-D	√	√	
		Select Cs-Rs	√	√	
		Select Cp-Q	√	√	
		Select Cp-D	√	√	
		Select Cp-G	√	√	
		Select Cp-Rp	√	√	
		Select R-X	√	√	
		Select Z -Theta (deg)	√	√	
		Select Z -Theta (rad)	√	√	
		Select G-B	√	√	
Select Y -Theta (deg)	√	√			
Select Y -Theta (rad)	√	√			
Display	Input Title	Type Title on Screen	√	√	
	Display Allocation	Select All Instruments	√		Because the 4287A is not provided with the IBASIC function, neither Half Display nor Basic status setting is available.
		Select Half Instrument Half Basic	√		
		Select All Basic	√		
		Select Basic Status	√		
Display Measurement Data	ON/OFF	√	√	For the 4287A, ON/OFF is separately switchable for each piece of the measured data.	
Update Display	ON/OFF		√	The 4287A is provided with a function that turns off update of the display in order to minimize the time needed to redraw the images on the screen display.	

3. Functional Differences Between 4286A and 4287A

Table B-5 Measurement functions

Function			4286A	4287A	Remarks
Calibration	CALIBRATION MENU	Run OPEN	√	√	The concept of calibration/compensation for the 4286A differs from that for the 4287A. In addition, for the 4286A, the compensation data for Rdc measurement is obtained together with that for calibration; for the 4287A, these kinds of data can be obtained separately.
		Run SHORT	√	√	
		Run LOAD	√	√	
		Run LOW-LOSS Capacitor	√	√	
		Select CAL POINT [FIXED] Interpolation Mode	√		Because the interpolation mode is not supported for the 4287A, the FIXED mode is not available; it is always in user mode.
		Select CAL POINT [USER] User Mode	√	√	
	RESUME CAL SEQUENCE		√	√	For the 4287A, even when the Run screen closes temporarily in the course of calibration/compensation, the calibration/compensation data already processed is not cleared.
Calibration	FIXTURE COMPEN	Run COMPEN OPEN	√	√	
		Run COMPEN SHORT	√	√	
		Run COMPEN LOAD	√		For the 4287A, LOAD compensation is not available; calibration should be used for this purpose.
		Select COMPEN POINT [FIXED] Interpolation Mode	√		Because the interpolation mode is not supported for the 4287A, the FIXED mode is not available.
		Select COMPEN POINT [USER] User Mode	√	√	The 4287A is always in user mode.
		RESUME COM SEQUENCE Data Resume	√	√	For the 4287A, even when the Run screen closes temporarily in the course of calibration/compensation, the calibration/compensation data already processed is not cleared.
		OPEN Compensation ON/OFF	√	√	
		SHORT Compensation ON/OFF	√	√	
		LOAD Compensation ON/OFF	√		For the 4287A, LOAD compensation is not available; calibration should be used for this purpose.
		FIXTURE	Select SELECT FIXTURE 16191	√	√
	Select SELECT FIXTURE 16192		√	√	
	Select SELECT FIXTURE 16193		√	√	
	Select SELECT FIXTURE 16194		√	√	
	Select SELECT FIXTURE 16196A			√	
Select SELECT FIXTURE 16196B			√		
	Select SELECT FIXTURE 16196C		√		

Table B-5 Measurement functions

Function			4286A	4287A	Remarks		
Calibration	FIXTURE	SELECT FIXTURE USER	√	√			
		Change and archive SAVE USER FIXTURE KIT	√	√	For the 4287A, the new setting immediately takes effect when change is made, without having to press a specific key.		
		MODIFY DEFINE EXTENSION	√	√			
		MODIFY LABEL FIXTURE	√	√			
		MODIFY KIT DONE (run)	√	√			
	CALIBRATION KIT	Use 7-mm CAL KIT	√	√			
		Use 3.5-mm CAL KIT	√				
		Use CAL KIT User Kit	√	√			
		Change and archive SAVE USER KIT	√	√			
		Input MODIFY OPEN G	√	√			
		Input MODIFY OPEN C	√	√			
		Input MODIFY SHORT L	√	√			
		Input MODIFY SHORT Rs	√	√			
		Input MODIFY LOAD L	√	√	For the 4286A, only Ls-Rs can be set for the equivalent circuit; whereas, for the 4287A, either Ls-Q or Cp-D can also be selected for the equivalent circuit.		
		Input MODIFY LOAD Rs	√	√			
		Change and Run STD DONE	√	√	The 4287A is not provided with a specific key associated with this function; the setting is run at the same time the data is input.		
		Input LABEL KIT Label	√				
		Calibration	COMPEN KIT	Change and archive SAVE COMPEN KIT	√	√	For the 4286A, only one value can be set for all frequencies; for the 4287A, each list sweep frequency can be set.
				Input MODIFY OPEN G	√	√	
Input MODIFY OPEN C	√			√			
Input MODIFY SHORT L	√			√			
Input MODIFY SHORT Rs	√			√			
Input MODIFY LOAD L	√				For the 4287A, LOAD compensation is not available; calibration should be used for this purpose.		
Input MODIFY LOAD Rs	√						
Change and Run STD DONE	√			√			
PORT EXTENSION	Port Extension ON/OFF		√				
	Input Extension Value		√				

Differences from Agilent 4286A
3. Functional Differences Between 4286A and 4287A

Table B-5 Measurement functions

Function			4286A	4287A	Remarks	
Sweep Setup	SEGMENT	Set Segment	√	√		
	EDIT		√	√		
	DELETE		√	√		
	ADD	Set Frequency within SEGMENT FREQ Segment		√	√	
		Set AVG within AVERAGING ON POINT		√	√	
		SEGMENT QUIT		√	√	
		SEGMENT DONE		√	√	
	CLEAR LIST	Clear YES/NO List Sweep Tables	√	√	For the 4287A, tables can be cleared one by one, or all tables can be cleared at once.	
LIST DONE	Complete Setting of List Sweep Tables	√	√			
Test Setup	LIMIT TEST MENU	Limit Test of PRI LIMIT ON/OFF Primary Parameter	√		The 4287A is not provided with the limit test function as provided for the 4286A.	
		Limit Test of PRI LIMIT ON/OFF Secondary Parameter	√			
		Input Limit of EDIT PRI LIMIT Primary Parameter	√			
		Input Limit of EDIT SEC LIMIT Secondary Parameter	√			
	BIN SORT MENU	BIN SORT ON/OFF Comparator ON/OFF	√	√	The concept of the comparator function for the 4287A is completely different from that for the 4286A.	
		Select TEST SEGMENT	√	√		
		Limit Setting of EDIT BIN SORT Bin Sort	√	√		
	BEEP	Select the setting to generate a beep when a test result is PASS.	√	√		
		Select the setting to generate a beep when a test result is FAIL.	√	√		
	HANDLER IF	Output	√	√	MODE: The 4286A is provided with two output lines for MODE1 and MODE2; the 4287A is provided with one output mode because it is based on a comparator concept that is completely different from that of the 4286A. ON/OFF: The 4286A can be set up independently. The 4287A is dependent on the ON/OFF of the comparator function and cannot be set up independently.	
Monitor	AC-V	AC-V Monitor Display	√	√		
	AC-I	AC-I Monitor Display	√	√		

3. Functional Differences Between 4286A and 4287A

Table B-5 Measurement functions

Function			4286A	4287A	Remarks
Delay Time	Sweep Delay Time	Input the sweep delay time inserted first	√	√	
	Point Delay Time	Input the delay time inserted at each measurement point	√	√	
Source	OSC LEVEL	Input Signal Level	√	√	The concept of setting the signal level differs between the 4286A and 4287A.
		Set the measure to V	√	√	
		Set the measure to I	√	√	
		Set the measure to dBm	√	√	
Contact Check	Rdc Meas	Run Rdc Measurement (ON/OFF)	√	√	
		Perform Rdc Pass/Fail Decision (ON/OFF)	√		
		Input Upper Limit of Rdc Pass/Fail Decision	√	√	
		Input Lower Limit of Rdc Pass/Fail Decision	√	√	
Trigger Mode	Sweep	Hold	√		
		Single Measurement	√		
		Continuous Measurement	√	√	
	Trigger	Free RUN Mode	√	√	
		External Trigger Mode	√	√	
		Manual Trigger Mode	√	√	
		(BUS Trigger Mode)	√	√	
	Trigger Event	Trigger at ON SWEEP	√	√	
		Trigger at ON POINT	√		Trigger at ON POINT is only supported for the 4287A.
	Trigger Polarity	Positive Edge Trigger	√	√	
Negative Edge Trigger		√	√		
Trigger		Trigger Button Used for Manual Trigger	√	√	

3. Functional Differences Between 4286A and 4287A

Table B-6 Instrument State functions

Function			4286A	4287A	Remarks
Copy	Print	Output to GPIB Printer	√		For 4287A, the printing function is not supported.
	Plot	Set and Output Plotter Output	√		The 4287A does not support output to a plotter.
	Copy Abort	Copy Abort	√	√	
	Copy Time	Display Time of Copy (ON/OFF)	√	√	
	LIST VALUES	Display Measurement Points and Measured Values	√	√	
	OPERATING PARAMETERS	Display All Measurement Settings	√	√	
	CAL KIT DEFINITION	Display All Calibration Kit Settings	√	√	
	COMPEN KIT DEFINITION	Display All Compensation Kit Settings	√	√	
	LIST SWEEP TABLE	Display List Sweep Table Settings	√	√	
	LIMIT TEST MENU TEST TABLE	Display Limit Test Settings	√	√	
	BIN SORT MENU SORT TABLE	Display All Bin Sort (Comparator) Settings	√	√	

3. Functional Differences Between 4286A and 4287A

Table B-6 Instrument State functions

Function			4286A	4287A	Remarks
Save/Recall	Save File	Save File with STATE	√	√	
		Save File with AUTOREC	√	√	
		Save DATA Only (Binary)	√	√	
		Save DATA Only (ASCII)	√	√	
		Saved Contents of SAVE DATA, RAM	√	√	
		Saved Contents of CAL DATA, CAL	√	√	
		Saved Contents of SAVE DATA, DATA	√	√	
		Saved Contents of SAVE DATA, TRACE	√	√	
		Save Data Graphically	√	√	Saved in HPGL form for the 4286A or BMP form for the 4287A.
	RECALL File	Read Contents of File	√	√	
	FILE UTILITIES	PURGE FILE	√	√	For the 4287A, executable only through the front panel (not executable with a GPIB command).
		CREATE DIRECTORY	√	√	
		CHANGE DIRECTORY	√	√	
		COPY FILE	√	√	
		INITIALIZE	√	√	
		FORMAT LIF	√		
	FORMAT DOS	√	√		
STORE DEV	Select Destination Disk or Memory	√	√		
System	IBASIC	BASIC function	√		
	SET CLOCK	Set Clock	√	√	
	BEEPER	Run Beep (ON/OFF)	√	√	
		Run Beep When Warning Occurs (ON/OFF)	√	√	

3. Functional Differences Between 4286A and 4287A**Table B-6 Instrument State functions**

Function			4286A	4287A	Remarks	
Local	SYSTEM CONTROLLER		√			
	ADDRESSABLE ONLY		√	√	The 4287A is always in addressable only mode.	
	SET ADDRESS	Set GPIB Address of Body		√	√	
		Set GPIB Address of Plotter		√		
		Set GPIB Address of Printer		√		
		Set Address of Controller		√		
Preset		Run Preset	√	√		

C

Improvement of Measurement Throughput by Screen Display Settings

This appendix describes a few ways to improve the throughput of measurement with the 4287A by adjusting the screen display settings.

How to improve 4287A measurement throughput by screen display settings

With the 4287A, you can minimize the measurement time by adjusting the screen display settings used during measurement.

Hiding the Screen Display

If no information needs to be displayed on the 4287A's LCD display (for example, when measurement is made through GPIB), you should hide the screen display. When the screen display is turned off, no time is needed for redrawing the image, and this significantly shortens the measurement time. For the procedure used to hide the screen display, refer to "Hiding the Screen Display" on page 166.

Optimizing the Settings of the Display Contents

If it is not possible to hide the screen display, try the following settings:

(1) Set the screen display to the list measurement display

If it is not necessary to display measured values in the large size of single point measurement display, set the screen display to the list measurement display. The single point measurement display requires a longer time for redrawing images than does the list measurement display because of the wider area used to display the measurement. Use of the list measurement display therefore reduces the measurement time. For the procedure used to set the list measurement display, refer to "Selecting Single Point Measurement or List Measurement" on page 157.

(2) Minimize the number of parameters shown

If one or more parameters do not need to be shown in the list measurement display, turn off the display. Each time measurement runs, the rewrite process occurs for the parameters currently shown on the display; thus, measurement time is accordingly lengthened. For the procedure of hiding the parameters shown, refer to "Selection of Display Parameters in List Measurement Display" on page 162.

(3) Turn off update of the screen display

When the display is in view, turning off update of the screen display reduces the time of internal workings (therefore the measurement time). When using this method, make sure that the measured values are updated but all other information, such as the status, is not updated. For the procedure used to turn off update of the screen display and the restrictions on this feature's use, refer to "Turning ON/OFF Update the LCD Display View" on page 167.

D

Table of Operations When Measurement Errors Occur

This appendix list the operations when errors (overload/error detected outside R_{dc} limit) are detected while using the Agilent 4287A.

Operations When Measurement Errors Occur

Table D-1 shows the LCD screen indications, GPIB output, and the parameters and interface signals that become active when any of the following items is detected.

- Overload
(Detected for ranging failure caused by DUT coming loose during measurement, etc.)
- R_{dc} limit deviation
(Detected when the R_{dc} measurement result does not fall within the limit range.)
- Simultaneous detection of overload and R_{dc} limit deviation.

Table D-1 Operations when errors occur

	LCD screen indication			Comparator sorting result	GPIB output			Parameter and interface signal that become active
	Measurement result				Measurement status	Measurement value *1	Comparator sorting result	
	Parameter 1 to 4	Measurement signal level monitor	R_{dc}					
Overload*2	9.9E37	9.9E37	Measurement value *3	14	1	9.9E37	14	/OVL
R_{dc} limit deviation	Measurement value *4	Measurement value *4	Measurement value *5 (indicated by red characters)		2	Measurement value *6		/RDC_OUT_OF_RANGE
Simultaneous detection of Overload *2 and R_{dc} limit deviation	9.9E37	9.9E37	Measurement value *5 (indicated by red characters)		3	9.9E37		/OVL /RDC_OUT_OF_RANGE

*1. All measurement values of parameters 1 to 4 (impedance measurement), measurement signal level monitor, and R_{dc} measurement.

*2. Ovl lights up red in the instrument status area at the bottom of the display.

*3. Overload is not detected for R_{dc} measurement.

*4. The measurement result is indicated as usual, but the indicated value may have been measured in a condition of improper contact.

*5. The measurement result is indicated as usual, but the characters are displayed in red.

*6. The measurement result is read out as usual, but the readout value may have been measured in a condition of improper contact.

E **Printing Out Measurement Results and Internal Data on a Printer**

This chapter explains how to print out the measurement and setup screens or other data on a printer connected to the printer parallel port on the rear panel of the 4287A.

Printer Support

NOTE

The printing function is not supported at present. This section explains function for the older version of 4287A specified with the serial numbers as below and is not applicable for the newer version

Table E-1 **Compatible printers (as of January 2000)**

Version	Serial number	Printing fuction
Older	JP1KG00xxx MY43200xxx	Yes
Newer	MY43300xxx	No

Printer Support

The printers that can be connected to the printer parallel port on the rear panel of the 4287A are shown in Table E-2.





Table E-2 **Compatible printers (as of January 2000)**

Maker	Model
Hewlett-Packard	DeskJet 895C Series (895Cse, 895Cxi)
	DeskJet 970C Series (970Cse, 970Cxi)
	DeskJet 930C

Procedure for Printing

Follow this procedure to print out the screen information on a printer.



1. Selecting the contents to be printed

- Step 1.** To print a screenshot of the information shown on the LCD display, display the screen that you want to print.
- Step 2.** Press **[Display]** on the front panel (**Capture** is imprinted on the front panel above the key). At this point, the displayed image data are copied to the clipboard (internal temporary memory). At the same time, the Display softkey menu appears.
- Step 3.** Turn the rotary knob  on the front panel to move the cursor in the softkey menu to **PRINT MENU**. Then press  to display the PRINT MENU softkey menu.
- Step 4.** Turn the rotary knob  on the front panel to move the cursor in the softkey menu to **CONTENT []**. Then press  to select the content to be printed (each press switches the selection in order).

Softkey Label	Printed Content
CONTENT [SCREEN]	Image copied to the clipboard.
CONTENT [SETUP]	Contents (measurement point setup table, calibration kit table, BIN sort setup table) of the selected measurement point table (active table).
CONTENT [LIST]	List of the parameters for each measurement point displayed on the list measurement display.

2. Setting the image format

If **CONTENT [SCREEN]** is selected in “1. Selecting the contents to be printed”, the image format is set by following this procedure.



- Step 1.** Turn the rotary knob  on the front panel to move the cursor in the softkey menu to **IMAGE []**. Then press  to select the image format (each press switches the selection in order).

Softkey Label	Printing Format
IMAGE [NORMAL]	Color printing with colors close to those of the actual screen display.
IMAGE [INVERTED]	Color printing with the colors of the actual screen display inverted* ¹ .
IMAGE [MONOCHROME]	Black and white printing with the colors of the actual screen display inverted* ¹ .

*1. Colors changed as follows: Yellow ↔ Blue, Red ↔ Light blue, White ↔ Black.

3. Setting paper orientation

The paper orientation (landscape or portrait) is set by following this procedure.

- Step 1.** Turn the rotary knob  on the front panel to move the cursor in the PRINT MENU softkey menu to **ORIENTATION []**. Then press  to select the orientation of the paper (the setting toggles with each press of the button).

Softkey Label	Paper Orientation
ORIENTATION [PORTRAIT]	Horizontal print orientation.
ORIENTATION [LANDSCAPE]	Vertical print orientation.

4. Selecting the printer model



- Step 1.** Turn the rotary knob  on the front panel to move the cursor in the PRINT MENU softkey menu to **SELECT DEFAULT PRINTER**. Then press  to display the Available Printers dialog box for selecting the printer (Figure E-1).



Figure E-1

Available Printers dialog box for selecting printer

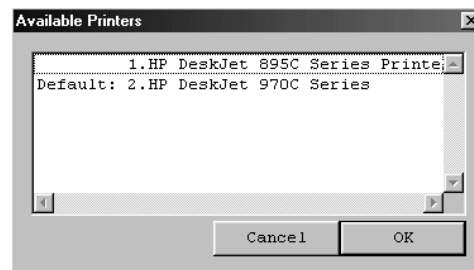

NOTE

If the printer to be used is already selected in the Available Printers dialog box (“Default:” is indicated to the left of the model name), the following operations for selecting the printer model are not required.

Step 2. Press  or  on the front panel to highlight the desired printer model.

NOTE

When you use the DeskJet 930C, select “HP DeskJet 970C Series”.

Step 3. Press  on the front panel the required number of times to move the cursor to the OK button.

Step 4. Press  on the front panel to close the Available Printers dialog box.

NOTE



To cancel the printer selection, move the cursor to the Cancel button in Step 3. Then press  to close the Available Printer dialog box. In this case, the printer selection remains unchanged from the last time a selection was made.

5. Starting and stopping printing

Step 1. Check that the printer is properly connected to the printer parallel port on the rear panel of the 4287A.

Step 2. Check that paper is properly loaded in the printer.

Step 3. Check that the printer is turned ON.



Step 4. Turn the rotary knob  on the front panel to move the cursor in the softkey menu to **PRINT**. Then press  to start printing.

NOTE

If you have selected CONTENT [SCREEN] as the item to be printed, save the image to the clipboard before starting print.

When there is no saved image on the clipboard, the image at the start of print is printed. Therefore, if you start print with the menu bar at the top of the screen using a mouse and the like, the pull-down menu displayed for the operation may partly hide the image you want to print. To avoid this, before starting print, press **[Display]** (**Capture** is shown above it) with the image you want displayed to save the image to the clipboard.

NOTE

To stop printing after it has been started, turn the rotary knob  on the front panel to move the cursor in the softkey menu to **ABORT PRINTING**. Then press  to stop printing.

F Error Messages

The Agilent 4287A provides error messages to indicate its operating status. This appendix describes the error messages of the 4287A in alphabetical order. To search error messages in order of error number, refer to the *4287A Programming Manual*.

Error Messages

A21 board can't be detected. The instrument will be automatically shutdown in 20 seconds.

Error messages are displayed at the top of the 4287A's LCD. Error messages generated during the execution of GPIB commands are preceded by the string “[GPIB]” or “[TELNET]” and can be read out using the GPIB command. This section gives you the description of each error message and its remedy.

NOTE

Errors with a negative error number are basically general errors for GPIB instruments defined by IEEE488.2. On the other hand, errors with a positive error number are those defined specifically for the 4287A.

Order of Error Number

A

A21 board can't be detected. The instrument will be automatically shutdown in 20 seconds.

The A21 board cannot be detected.

The 4287A will be automatically shut down in approximately 20 seconds after the occurrence of this error. The 4287A is at fault and needs repair.

Contact the Agilent Technologies sales office or the company you purchased this instrument.

NOTE

This is a special error that occurs at the startup of the 4287A. The error message, unlike other ones, is displayed in the box that appears at the center of the LCD display, instead of the top of it. No error number is assigned.

A24 GPIB board can't detected. Press OK to continue.

The A24 board cannot be detected.

Although the measurement screen appears normally, the instrument has started up abnormally (GPIB is disabled). To recover the normal status, reboot the 4287A (turn OFF the standby switch and then ON again).

If this error persists after rebooting the 4287A, or occurs frequently, the 4287A is at fault and needs repair. Contact the Agilent Technologies sales office or the company you purchased this instrument.

NOTE

This is a special error that occurs at the startup of the 4287A. The error message, unlike other ones, is displayed in the box that appears at the center of the LCD display, instead of the top of it. No error number is assigned.

6 **Additional standards needed**

Before the completion of all of the data measurement required for calculating the calibration/compensation coefficients, a GPIB command requiring any of the measurement data was sent. For example, when only the OPEN and SHORT measurements of the calibration kit have been complete, the **:CORR1:COLL:SAVE** command, which performs calculation of the calibration coefficients, was sent.

Measure all the required data.

B

-168 **Block data not allowed**

A block data element was received where the 4287A does not accept any block data element.

C

7 **Calibration required**

Though the calibration was not turned on, a GPIB command was sent that is valid only when the calibration is turned on. For example, the **:CORR2:COLL** command, which obtains the data for calculating the compensation coefficients, was executed.

Turn on the calibration.

62 **Can't execute data examination**

The data for statistical analysis has been acquired, but change was made to the settings during the data acquisition, so statistical analysis cannot be executed.

Acquire the data for statistical analysis with the current settings.

-148 **Character data not allowed**

A character data element (that did not violate the standard) was received where the 4287A does not accept any character data element.

-100 **Command error**

A comprehensive syntax error occurred for which the 4287A could not detect further details. This error code simply indicates the occurrence of a command error that is defined in IEEE488.2,11.5.1.1.4.

11 **Compensation required**

Although compensation was not turned on, a GPIB command that is valid only when compensation is turned on was sent. For example, the **:DATA:CMP{1-3}** command, which reads out the compensation coefficients, was executed when compensation was turned off.

Turn on the compensation.

D

-230 **Data corrupt or stale**

The data may be invalid or a newly initiated read operation has not been completed since the latest access.

-222 **Data out of range**

A data element (that did not violate the standard) out of the defined range of the 4287A was received.

-104 **Data type error**

The parser recognized impossible data elements. For example, numeric value or string data was expected, but block data was sent.

E

-200 **Execution error**

A comprehensive execution error occurred for which the 4287A could not detect further details. This error code simply indicates the occurrence of an execution error that is defined in IEEE488.2,11.5.1.1.5.

-123 **Exponent too large**

The absolute value of the exponent exceeds 32,000. (Refer to IEEE488.2,7.7.2.4.1.)

-178 **Expression data not allowed**

An equation data element was received where the 4287A does not accept any equation data element.

-170 **Expression error**

An error not included in error numbers between -171 and -179 occurred during the syntax analysis of equation data.

F

-256 **File name not found**

The specified filename was not found and, as a result, the command was not executed correctly. For example, you attempted to read a file that does not exist on the disk.

This message is also displayed when you attempt to read a file on a floppy disk drive but no floppy disk is correctly inserted into the drive.

G

-105 **GET not allowed**

A group execution trigger (GET) was received in a program message. (Refer to IEEE488.2,7.7.)

I

- 224 **Illegal parameter value**
The value of the parameter is illegal.
- 213 **Init ignored**
Another measurement was being executed and the measurement start request (: INIT command) was ignored.
- 161 **Invalid block data**
Block data was expected but the sent block data was invalid for some reasons. (Refer to IEEE488.2,7.7.6.2.) For example, the END message was received before the length of the block data was reached.
- 101 **Invalid character**
Invalid characters exist in the program message string. For example, for a correct program message, “: CALC: PAR1: FORM LS”, an ampersand (&) is inserted by mistake as “: CALC: PAR1: FORM&LS”.
- 121 **Invalid character in number**
An invalid character for the data type of the syntax analysis target was received. For example, alphabetical characters exist in a decimal value, or “9” exists in octal data.
- 171 **Invalid expression**
The equation data element is invalid. (Refer to IEEE488.2,7.7.7.2.) For example, parentheses are not paired or a character violates the standard.
- 106 **Invalid File Name**
When executing the save/recall file command, a file name string was invalid. For example, when executing the save command, no extension for the file was specified.
Specify a valid file name.
This error also occurs if the floppy disk has not been correctly inserted into the drive or the disk is write-protected when you attempt to save a file onto it.
- 103 **Invalid separator**
The parser (syntax analysis program) expected a separator, but a character other than a separator was sent. For example, although the correct way is using “;” to separate two sent program messages such as “: CALC: PAR1: FORM LS; *OPC?”, the semicolon (;) needed to separate the program messages is missing, as in “: CALC: PAR1: FORM LS *OPC?”.
- 151 **Invalid string data**
Character string data was expected but the sent string data was invalid for some reasons. (Refer to IEEE488.2,7.7.5.2.) For example, the END message was received before the end quotation mark character appeared.
- 131 **Invalid suffix**
The suffix does not meet the syntax defined in IEEE488.2,7.7.3.2 or is inappropriate for the 4287A.

M

-109 **Missing parameter**

The number of parameters is less than that the command requires. For example, although the **:SOUR:LIST:TABL** command requires one parameter such as “**:SOUR:LIST:TABL 3**”, no parameter is added, as in “**:SOUR:LIST:TABL**”.

N

0 **(No error)**

No error has occurred.

This message is not displayed on the LCD. It is returned as the error number if no error has occurred in the instrument when the **:SYST:ERR?** command is sent through GPIB.

61 **No data available on memory**

Although no data for statistical analysis has been acquired, the **:CALC:EXAM:GET?** command that executes statistical analysis and acquires the results was sent.

Acquire the data for statistical analysis.

-120 **Numeric data error**

Numeric data (including numeric data without a decimal point) causes an error. A numeric value error other than -121 to -129 occurred.

-128 **Numeric data not allowed**

A numeric value data element (that did not violate the standard) was received where the 4287A does not accept any numeric value data element.

O

-321 **Out of memory**

An internal operation needed more memory than was available.

P

-108 **Parameter not allowed**

The number of parameters is larger than that the command requires. For example, although the **:SOUR:LIST:TABL** command requires one parameter such as “**:SOUR:LIST:TABL 3**”, two parameters are added, as in “**:SOUR:LIST:TABL 3,5**”.

120 **PLL unlock**

Phase lock loop was not locked

If you entered the external reference signal, check to see if it is correct. If you entered the correct signal or you did not enter it, the instrument needs adjustment or repair. Contact your local Agilent Technologies sales office or the company you purchased this instrument from.

198 **Power on test failed**
In the power-on self test, a fault was detected.
Contact your local Agilent Technologies sales office or the company you purchased this instrument from.

22 **Printer error**
The printer does not respond to control from the 4287A.
Check the power to the printer, cable connections, paper, and so on.

-112 **Program mnemonic too long**
The length of the header exceeds 12 characters. (Refer to IEEE488.2,7.6.1.4.1.)

Q

-430 **Query DEADLOCKED**
Status that causes a “DEADLOCKED” query error. (Refer to IEEE488.2,6.3.1.7.) This error occurs, for example, when both input and output buffers become full and the 4287A cannot continue processing.

-400 **Query error**
A comprehensive Query error occurred for which the 4287A could not detect further details. This code simply indicates the occurrence of a query error that is defined in IEEE488.2,11.5.1.1.7 and 6.3.

-410 **Query INTERRUPTED**
Status that causes an “INTERRUPTED” query error. (Refer to IEEE488.1,6.3.2.3.) This error occurs, for example, when data byte (DAB) or GET is received after Query has been initiated but before the response has been completely sent.

-420 **Query UNTERMINATED**
Status that causes an “UNTERMINATED” query error. (Refer to IEEE488.2,6.3.2.) This error occurs, for example, when the 4287A is specified as a talker and an incomplete program message is received.

-440 **Query UNTERMINATED after indefinite response**
In a certain program message, after a Query that requested an ambiguous response was executed, another Query was received. (Refer to IEEE488.2,6.5.7.5.7.)

R

105 **Recall error**
An error occurred while reading out (recalling) a file. For example, you attempted to read out a file with invalid contents, such as an instrument setting file with extension “.sta” that was saved using an instrument other than the 4287A).
Check to see if the contents of the file is valid.

S

- 104 **Save error**
- When saving a file, anomalies in the storage media were detected. For example, if you attempt to save a file on a floppy disk when there is not enough space on the disk.
- Ensure that there is enough space on the floppy disk.
- 221 **Setting conflict**
- A program data element complying with the syntax standard was analyzed but the 4287A could not execute it at the time.
- 150 **String data error**
- An error not included in error numbers between -151 and -159 occurred during the syntax analysis of a string data element.
- 158 **String data not allowed**
- A string data element was received where the 4287A does not accept any string data element. For example, a parameter that should not be enclosed with double quotation marks (“”) such as **ABC** is sent with them, as in **“ABC”**.
- 138 **Suffix not allowed**
- A suffix is added to a numeric value element to which no suffix can be added.
- 134 **Suffix too long**
- The suffix contains the notation of 12 characters or more. (Refer to IEEE488.2,7.7.3.4.)
- 102 **Syntax error**
- There is a command or data type that cannot be recognized. For example, for a correct program message, “**:SYST:PRES**”, an extra colon (:) is inserted by mistake, as in “**:SYST: :PRES**”.
- 310 **System error**
- One of the “system errors” defined for the 4287A occurred.

T

- 124 **Too many digits**
- The number of digits of the mantissa of the decimal value data element exceeds 255, aside from preceding 0s. (Refer to IEEE488.2,7.7.2.4.1.)
- 223 **Too much data**
- The received block, equation, or string type program data complied with the standard but its amount exceeded the limit that the 4287A can deal with due to memory or device-specific conditions related to memory.
- 211 **Trigger ignored**
- A trigger command or trigger signal was received and recognized by the 4287A but was ignored due to the timing relationship with the 4287A (for example, when the 4287A’s trigger system is not in Waiting for Trigger state).

U

-113

Undefined header

A header not defined for the 4287A was received. For example, “*XYZ”, which is not defined for the 4287A, was received.

Error Messages
Undefined header

G Information on Maintenance

This appendix explains the measures you should take to maintain the Agilent 4287A.

Cleaning this Instrument

This section describes how to clean the instrument.

WARNING

To protect yourself from electrical shock, be sure to unplug the power cable from the outlet before cleaning the instrument.

Never clean the internal components of the instrument.

Cleaning an LCD

Use one of the following methods to clean the display surface regularly.

- For normal cleaning, wipe the surface gently with a soft cloth that is dry or wetted with a small amount of water and wrung tightly.
- When stains are difficult to remove, gently wipe the surface with cloth dampened with a small amount of ethanol or isopropyl alcohol.

NOTE

Do not use chemicals other than ethanol and isopropyl alcohol to wet the cleaning cloth.

Maintenance of Connectors/Ports

A 3.5-mm connector (7-mm connector when the conversion adapter is connected) is used for the test head of the 4287A. The N-type connector is used for the front panel. In the RF band, dirt or damage to connectors significantly affects measurement accuracy. Take special care about the following.

- Always keep the connectors free from stains and dust.
- Do not touch the contact surface on the connectors.
- Do not plug damaged or scratched connectors into the test ports.
- Use compressed air for cleaning connectors. Do not use abrasives under any circumstance.

Observe the above instruction for the connectors and ports not on the test head or the front panel.

Procedure to replace center conductor collet of 7-mm connector.

Required tools

	Agilent part number
Collet removal tool	5060-0370
6-slot precision collet	85050-20001

Removing center conductor collet

Follow these steps to remove the center conductor collet of the 7-mm connector.

- Step 1.** Turn the outer part of the 7-mm connector clockwise viewed from above to completely expose the connector sleeve.

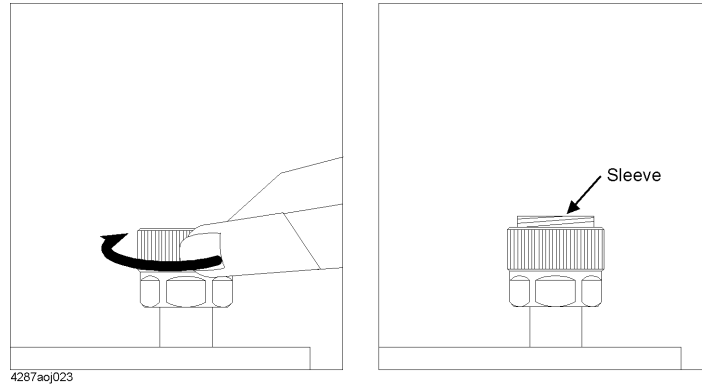

- Step 2.** Pull up the handle of the collet replacement tool (Figure A below) and, while keeping pulling the handle, insert the replacement tool slowly until it touches the end of the connector (Figure B below).

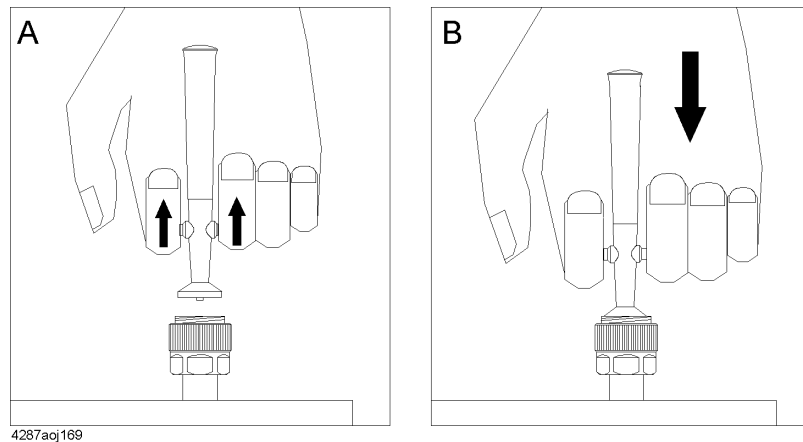

- Step 3.** After releasing the handle (Figure A below), pull up the collet removal tool (Figure B below) to remove the old collet.

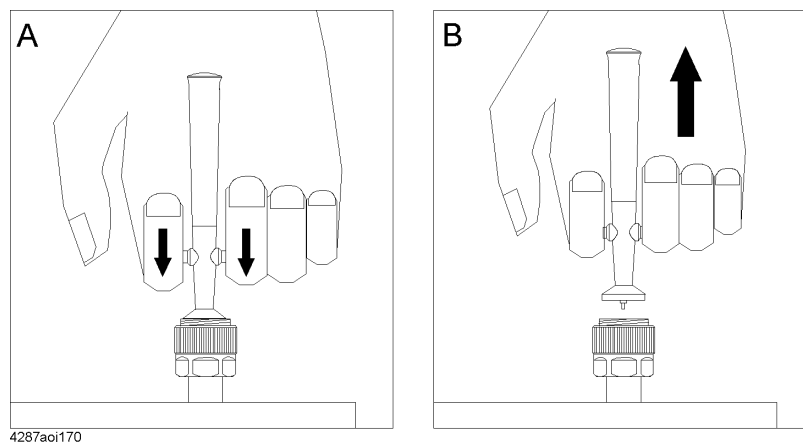

Information on Maintenance
Cleaning this Instrument

Installing center conductor collet

Follow these steps to install the center conductor collet of the 7-mm connector.

Step 1. Insert the collet into the center conductor of the connector.

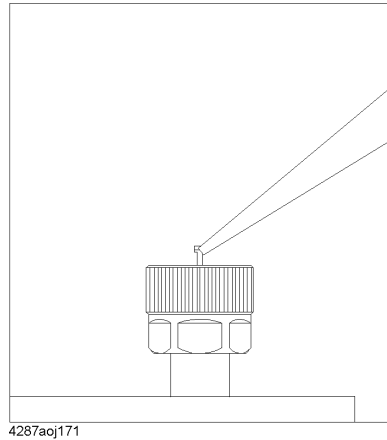

Step 2. Push the collet slowly as far as it will go.

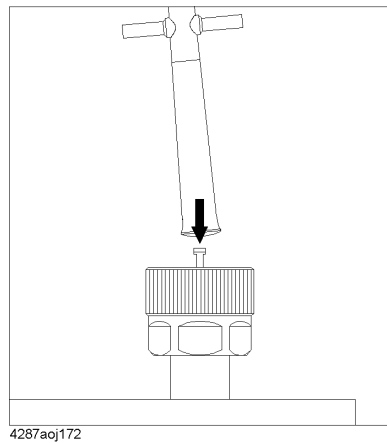

Cleaning a Display Other than an LCD

To remove stains on parts other than the LCD, test ports, and other connectors/ports of the instrument, wipe them gently with a soft cloth that is dry or wetted with a small amount of water and wrung tightly.

Cautions Applicable to Requesting Repair, Replacement, Regular Calibration, etc.

Devices to be Sent Back for Repair or Regular Calibration

If it is necessary to send the unit to the Service Center of Agilent Technologies for repair or regular calibration, please follow the instructions below.

Sending Back Your Instrument Set

When you request our service center for repair or periodical calibration of this instrument, please include the test head (with 1-m cable), the calibration kit (if Option 001 is not specified), the test fixture stand (if Option 002 is not specified), and the 3.5-mm-to-7-mm conversion adapter (if Option 003 is not specified) in the 4287A to be sent. You do not have to send other accessories.

Packing

Use the original package and shock absorbers, or equivalent antistatic packing materials, when sending the unit.

Shipping Address

For the location of the nearest Agilent Technologies Service Center, contact the Customer Contact listed at the end of this brochure.

Recommended Calibration Period

The recommended calibration period for this instrument is one year. The user is recommended to request the Company's Service Center to perform regular calibration every year.

Information on Maintenance

Cautions Applicable to Requesting Repair, Replacement, Regular Calibration, etc.

Symbols

Δ , 164
[Capture] key, 76

Numerics

16191A
 selection guideline, 45
16192A
 selection guideline, 45
16193A
 selection guideline, 45
16194A
 selection guideline, 45
16195B
 contents, 18, 280
16196A
 selection guideline, 45
16196B
 selection guideline, 45
16196C
 selection guideline, 45
3*SD/Mean
 statistical analysis parameter, 206
3.5-inch floppy disk drive, 74
3.5-mm-to-7-mm Adapter
 contents, 18, 280
4286A
 Differences Between 4286A and 4287A Hardware, 298
 Functional Differences Between 4286A and 4287A, 301
 Main Differences Between 4286A and 4287A, 296
7-mm Calibration Kit
 contents, 18, 280

A

abnormal measurements
 statistical analysis parameter, 206
ABS
 Limit mode, 181
Absolute mode
 Limit mode, 181
Absolute value of admittance
 BIN sort measurement parameter, 179
 Selection of Measurement Parameters, 160
Absolute value of impedance
 BIN sort measurement parameter, 179
 Selection of Measurement Parameters, 160
Additional standards needed
 Error message, 320
Admittance phase (deg.)
 BIN sort measurement parameter, 179
 Selection of Measurement Parameters, 160
Admittance phase (radian)
 BIN sort measurement parameter, 179
 Selection of Measurement Parameters, 160
ALL, 185
[Alt] key

 function, 77
Altitude
 General Characteristics, 275
 Operation environment, 20
Arrow keys
 function, 75
assistance, 6
Automatic Equipment
 precautions required when connecting, 47
automatic setting file
 specifying creation, 127, 130, 133, 140, 144
autorec.sta, 127
Averaging factor
 How to change, 109
 Names and Functions of Display Areas, 86, 92
 Selection of Display Parameters, 162
 setting range, 271
AVG
 Selection of Display Parameters, 162

B

B, 179
 BIN sort measurement parameter, 179
 Selection of Measurement Parameters, 160
BACK LIGHT, 239
[Back Space] key
 function, 77
Backlight
 turning OFF, 239
Basic Measurement Characteristics
 Specifications and Supplemental Performance
 Characteristics, 253
Basic Operations, 49
Beep
 completion beep ON or OFF, 233
 warning beep ON or OFF, 233
BEEP COMPARATOR, 234
BEEP DONE, 233
Beep Sound
 BIN sort function result, 234
 Setting, 233
BEEP WARN, 234
BIN count
 display results, 190
 on/off, 190
 reset, 191
BIN COUNT MENU soft key, 190, 191
BIN number
 Names and Functions of Display Areas, 97
BIN ON/OFF
 Concept of BIN sort setting, 175
 Names and Functions of Display Areas, 97
 setting, 186
Bin ON/OFF, 175
BIN range
 Setting, 183
BIN range mode, 185

-
- Concept of BIN sort setting, 175
 - selecting, 185
 - BIN range setting
 - Example of Settings for BIN Sorting, 193
 - BIN Sort Function
 - Overview, 172
 - BIN sort judgment
 - Internal flow, 176
 - BIN sort result
 - Beep sound, 234
 - Names and Functions of Display Areas, 85
 - BIN sort setting
 - Concept, 175
 - BIN Sorting
 - example, 192
 - turning on, 189
 - BIN sorting setup display
 - Function, 82
 - How to set, 177
 - Names and Functions of Display Areas, 97
 - BIN sorting setup tab
 - Names and Functions of Display Areas, 97
 - BINs
 - setting concept, 174
 - bmp, 216
 - Built-in 3.5-inch floppy disk drive, 74
 - Built-in Speaker
 - Setting, 233
 - Bus
 - equipment status display, 87
 - C**
 - [Cal/Compen] key
 - function, 76
 - Calibration
 - Basic Operations, 57
 - overview, 116
 - Calibration and Compensation
 - Preventing Mistakes, 151
 - Specifications and Supplemental Performance Characteristics, 270
 - Calibration and Compensation Procedures
 - Dedicated Test Fixture, 120
 - Non-Dedicated Test Fixture, 135
 - calibration and compensation wizard
 - Basic Operations, 57
 - calibration data
 - erase, 123
 - Calibration Dialog box, 122, 131, 136
 - Calibration Kit
 - circuit model, 145
 - definition procedure, 145
 - How to Define, 145
 - Calibration kit selection
 - Names and Functions of Display Areas, 93
 - Calibration kit setup display
 - Function, 82
 - Names and Functions of Display Areas, 93
 - Calibration kit setup tab
 - Names and Functions of Display Areas, 93
 - Calibration kit Setup Table
 - Saving in CSV Format, 219
 - calibration reference plane, 117
 - DUT connection terminal
 - calibration and compensation procedure, 131, 142
 - required calibration and compensation, 117
 - Test head coaxial terminal
 - calibration and compensation procedure, 121, 135
 - [Cancel] key
 - function, 77
 - [Capture] key
 - function, 76
 - Capture key
 - Saving Screen Display, 216
 - certification, 4
 - Circuit model
 - Names and Functions of Display Areas, 94
 - Cleaning, 330
 - instructions, 46
 - CLEAR soft key
 - BIN count Function, 191
 - clock
 - setting the internal clock, 43
 - Cmp
 - equipment status display, 87
 - Color LCD display, 75
 - comparator
 - turning on, 189
 - Comparator setup tab
 - Names and Functions of Display Areas, 97
 - Compatible Printers, 314, 315
 - Compensation
 - Basic Operations, 57
 - overview, 116
 - port extension, 116
 - compensation dialog box, 128
 - Compensation Kit
 - circuit model, 147
 - definition procedure, 147
 - How to Define, 147
 - Compensation kit selection
 - Names and Functions of Display Areas, 95
 - Compensation kit setup display
 - Function, 82
 - Names and Functions of Display Areas, 95
 - Compensation kit setup tab
 - Names and Functions of Display Areas, 95
 - Compensation kit Setup Table
 - Saving in CSV Format, 219
 - completion beep
 - ON or OFF, 233
 - Comptr
 - equipment status display, 87
 - condensation

- Operation environment, 20
- Conditions for Defining Accuracy
 - Measurement accuracy, 255
- Connectors
 - Maintenance, 330
- CONTENT [LIST]
 - Printing, 316
- CONTENT [SCREEN]
 - Printing, 316
- CONTENT [SETUP]
 - Printing, 316
- contents
 - 4287A shipping container, 18
- Cor
 - equipment status display, 87
- Cp
 - BIN sort measurement parameter, 179
 - Selection of Measurement Parameters, 160
- Cs
 - BIN sort measurement parameter, 179
 - Selection of Measurement Parameters, 160
- csv, 217, 219, 221
- CSV Format
 - Saving the List Measurement Display, 217, 221
- D**
- D
 - BIN sort measurement parameter, 179
 - Selection of Measurement Parameters, 160
- Data Logging
 - Statistical Analysis, 207
- Data Logging Size, 207
- Data Measurement Points
 - Measurement Support Functions, 270
- date
 - setting the date/time, 43
 - setting the internal clock, 290
- DATE & TIME [LIVE]soft key, 291
- DATE & TIME [OFF]soft key, 291
- DATE & TIME [STAMP]soft key, 291
- Date and Time
 - Names and Functions of Display Areas, 87
 - setting dialog box, 288
 - turning On or Off the display, 291
- daylight saving time
 - setting the automatic daylight saving time adjustment, 289
- DC open/short compensation data
 - How to measure, 130, 140
- DC open/short/load calibration data
 - How to measure, 144
 - at DUT connection terminal, 133
 - at Test head coaxial terminal, 126, 137
- DC resistance (Rdc)
 - calibration data, 122, 132, 136
 - compensation data, 128
 - measurement precautions, 47
 - Setting the limit, 151
- DC resistance (Rdc) measurement
 - Offset cancel function, 113
 - On/Off, 113
 - Specifications and Supplemental Performance Characteristics, 270
- DC resistance (Rdc) measurement value
 - Names and Functions of Display Areas, 86
 - Selection of Display Parameters, 162
- DC resistance (Rdc) upper and lower limit values
 - Names and Functions of Display Areas, 97
 - setting, 188
- DC standard value
 - Names and Functions of Display Areas, 94, 96
- Dedicated Test Fixture
 - Calibration and Compensation Procedures, 120
- Definition of Each Parameter
 - Measurement accuracy, 256
- Del
 - equipment status display, 87
- Δ , 164
- DEV
 - Limit mode, 181
- Deviation, 164
- Deviation measurement mode, 164
- Deviation mode
 - Limit mode, 181
 - setting reference value, 182
- dialog box
 - Date and Time setting, 288
- Differences
 - Differences from Agilent 4286A, 295
- Dimensions
 - General Characteristics, 278
- disconnecting device, 21
- DISPLAY, 165, 166
- display
 - switching, 83
 - turning the date/time display ON and OFF, 44
 - Type/Size, Resolution, 271
- Display contents
 - update OFF, 167
- [Display] key
 - function, 76
- Dissipation factor
 - BIN sort measurement parameter, 179
 - Selection of Measurement Parameters, 160
- documentation map, 7
- DUT
 - about connection, 46
 - connection and measurement, 69
- DUT port, 78
- E**
- Edit
 - Setup display menu, 91
- ELEC. LENGTH [], 149
- Electrical Length, 149

-
- Registering the Unregistered Test Fixtures, 149
 - EMC
 - General Characteristics, 276
 - Enter keys
 - function, 75
 - entire range, 185
 - ENTRY, 76
 - Entry block, 76
 - Environmental Requirements, 20
 - Equipment status
 - Names and Functions of Display Areas, 87
 - Equivalent parallel capacitance
 - BIN sort measurement parameter, 179
 - Selection of Measurement Parameters, 160
 - Equivalent parallel conductance
 - BIN sort measurement parameter, 179
 - Selection of Measurement Parameters, 160
 - Equivalent parallel inductance
 - BIN sort measurement parameter, 179
 - Selection of Measurement Parameters, 160
 - Equivalent parallel resistance
 - BIN sort measurement parameter, 179
 - Selection of Measurement Parameters, 160
 - Equivalent parallel susceptance
 - BIN sort measurement parameter, 179
 - Selection of Measurement Parameters, 160
 - Equivalent series capacitance
 - BIN sort measurement parameter, 179
 - Selection of Measurement Parameters, 160
 - Equivalent series inductance
 - BIN sort measurement parameter, 179
 - Selection of Measurement Parameters, 160
 - Equivalent series reactance
 - BIN sort measurement parameter, 179
 - Selection of Measurement Parameters, 160
 - Equivalent series resistance
 - BIN sort measurement parameter, 179
 - Selection of Measurement Parameters, 160
 - Error correction
 - DC resistance (Rdc) measurement, 270
 - Error message
 - List, 320
 - exclusive remedies, 5
 - Ext
 - equipment status display, 87
 - Ext Ref In, 80
 - Ext Trig, 79
 - Extension
 - .bmp, 216
 - .csv, 217, 219, 221
 - .sta, 214
 - External monitor output terminal, 80
 - External Reference Signal Input Connector
 - Specifications and Supplemental Performance Characteristics, 273
 - External reference signal input terminal, 80
 - External Trigger Input Connector
 - Specifications and Supplemental Performance Characteristics, 273
 - External trigger input terminal, 79
 - ExtRef
 - equipment status display, 87
 - F**
 - Faulty BIN
 - setting, 187
 - File
 - Setup display menu, 91
 - Fixture selection
 - How to carry out, 127
 - overview, 116
 - floppy disk drive, 74
 - FPANEL LOCK, 235
 - free space
 - required free space in case of emergency, 21
 - FREQ
 - Selection of Display Parameters, 162
 - Frequency
 - Check the power supply, 35
 - How to change, 108
 - Source characteristics, 253
 - Front Handles
 - How to Install, 22
 - Front Panel
 - Names and Functions, 74
 - Front panel keys
 - locking, 235
 - Furnished accessories, 280
 - fuse
 - blown fuse, 37
 - spec, 37
 - G**
 - G, 179
 - BIN sort measurement parameter, 179
 - Selection of Measurement Parameters, 160
 - Gateway address
 - checking and editing, 287
 - GPIB
 - Measurement Data Transfer Time, 269
 - Specifications and Supplemental Performance Characteristics, 271
 - Switching Time for Setup Change, 269
 - Switching time of setup, 262
 - GPIB ADDR [], 226
 - GPIB Address
 - Checking and Editing, 226
 - GPIB connector, 80
 - H**
 - Handle Kit
 - contents, 19, 280
 - How to Install, 22

-
- Handler
 - precautions required when connecting, 47
 - Handler interface, 80
 - Specifications and Supplemental Performance Characteristics, 272
 - history,
 - manual printing, 2
 - How to Use This Operation Manual, 15
 - Humidity
 - General Characteristics, 275
 - I**
 - IMAGE [INVERTED]
 - Printing, 317
 - IMAGE [MONOCHROME]
 - Printing, 317
 - IMAGE [NORMAL]
 - Printing, 317
 - Image format
 - setting, 316
 - I-mon
 - Selection of Display Parameters, 162
 - Impedance Measurement Accuracy
 - Calculated Examples, 258
 - Impedance phase (deg.)
 - BIN sort measurement parameter, 179
 - Selection of Measurement Parameters, 160
 - Impedance phase (radian)
 - BIN sort measurement parameter, 179
 - Selection of Measurement Parameters, 160
 - In, 185
 - Incoming Inspection, 18
 - Initial registration, 40
 - initialize, 102
 - Inside, 185
 - Installation, 17
 - INSTR STATE, 76
 - Instrument state block, 76
 - Int
 - equipment status display, 87
 - Int Ref Out, 80
 - Internal Clock
 - setting, 288
 - Internal Reference Signal Output Connector
 - Specifications and Supplemental Performance Characteristics, 273
 - Internal reference signal output terminal, 80
 - IP address
 - checking and editing, 287
 - K**
 - KBD LOCK, 236
 - Key Operation
 - Overview, 99
 - Keyboard
 - contents, 18, 280
 - How to connect, 29
 - locking, 236
 - keyboard port, 81
 - KYBD, 81
 - L**
 - Label
 - Names and Functions of Display Areas, 89
 - LAN
 - How to connect, 30
 - LAN Interface, 273
 - LAN port, 80
 - LAN Settings
 - Checking and Editing, 287
 - LCD Display, 75
 - Names and Functions of Display Areas, 82
 - turning OFF the Backlight, 239
 - turning ON/OFF update, 167
 - Limit Mode
 - Concept of BIN sort setting, 175
 - setting, 181
 - limitation of warranty, 5
 - LINE, 79
 - List Measurement
 - Details of Measurement Time, 265
 - measurement and display, 71
 - measurement time example, 267
 - Number of Measurement points, 271
 - Number of tables, 271
 - Selecting, 157
 - List measurement display
 - Function, 82
 - Names and Functions of Display Areas, 89
 - Saving in CSV Format, 217, 221
 - load calibration
 - Basic Operations, 63
 - overview, 116
 - load calibration data
 - How to measure, 144
 - at DUT connection terminal, 133
 - at Test head coaxial terminal, 125, 137
 - Load standard value
 - Names and Functions of Display Areas, 94
 - Lock
 - all, 238
 - Front panel keys, 235
 - Keyboard, 236
 - keyboard, 236
 - mouse, 237
 - LOCK ALL, 238
 - lower limit value
 - DC resistance(Rdc), 188
 - Setting BIN Range, 184
 - Low-loss capacitor calibration
 - Basic Operations, 62
 - Measurement Support Functions, 270
 - overview, 116
 - low-loss capacitor calibration data

- How to measure
 - at Test head coaxial terminal, 126, 138
- Lp
 - BIN sort measurement parameter, 179
 - Selection of Measurement Parameters, 160
- Ls
 - BIN sort measurement parameter, 179
 - Selection of Measurement Parameters, 160
- M**
- maintenance, 329
- Man
 - equipment status display, 87
- manual changes, 283
- manual printing history, 2
- Maximum power consumption
 - Check the power supply, 35
- Maximum value (Max)
 - statistical analysis parameter, 206
- Mean value (Mean)
 - statistical analysis parameter, 206
- [Meas View] key
 - function, 75
- MEASUREMENT, 75
- Measurement accuracy
 - Basic Measurement Characteristics, 255
 - Calculated Impedance Measurement Accuracy Examples, 258
- Measurement block, 75
- Measurement condition setup time, 266
- Measurement data acquirement time, 266
- measurement display, 82
- Measurement display menu bar
 - Names and Functions of Display Areas, 84
- Measurement frequency
 - Names and Functions of Display Areas, 85, 92, 93, 95
 - Selection of Display Parameters, 162
- Measurement parameter
 - Basic Measurement Characteristics, 253
 - BIN sorting, 179
 - Concept of BIN sort setting, 175
 - Example of Settings for BIN Sorting, 193
 - how to change, 70
 - Names and Functions of Display Areas, 88
- Measurement Point
 - BIN sorting, 177
 - How to add, 105
 - how to change, 69
 - How to Set, 103
 - Selection, 159
- Measurement point delay time, 266
- Measurement point number, 193
 - Concept of BIN sort setting, 175
 - Names and Functions of Display Areas, 85, 89, 92, 93, 95
- Measurement point setup display
 - Function, 82
 - How to bring up, 103
 - Names and Functions of Display Areas, 91
- Measurement point setup tab
 - Names and Functions of Display Areas, 91
- Measurement point Setup Table
 - Saving in CSV Format, 219
- Measurement Point Table
 - How to Select, 158
- Measurement point table selection buttons
 - Names and Functions of Display Areas, 92
- Measurement range
 - Basic Measurement Characteristics, 253
 - DC resistance (Rdc) measurement, 270
- Measurement resolution
 - DC resistance (Rdc) measurement, 270
- Measurement terminal
 - Specifications and Supplemental Performance Characteristics, 273
- Measurement Throughput
 - Improvement of Measurement Throughput by Screen Display Settings, 309
- Measurement Uncertainty, 255
 - DC resistance (Rdc) measurement, 270
 - Measurement accuracy, 255
- Measurement uncertainty
 - , 270
- measurement value
 - Names and Functions of Display Areas, 88
- Measurement value range
 - Example of Settings for BIN Sorting, 197
- Messages, 320
- Mini-DIN keyboard port, 81
- Minimum value (Min)
 - statistical analysis parameter, 206
- MOUSE, 80
- Mouse
 - contents, 18, 280
 - How to connect, 29
 - locking, 237
 - MOUSE LOCK, 237
 - Mouse port, 80
- N**
- N(m)-SMA(f) Adapter
 - contents, 18, 280
- NAVIGATION, 75
- Navigation block, 75
- Network
 - Configuring, 228
 - network addresses
 - checking and editing, 287
 - Network Identification Wizard, 40
- normal measurements
 - statistical analysis parameter, 206
- numeric entry keys
 - function, 76

O

- Offset cancel function, 113
 - Offset delay
 - Names and Functions of Display Areas, 94
 - open calibration
 - Basic Operations, 61
 - overview, 116
 - open calibration data
 - How to measure, 143
 - at DUT connection terminal, 132
 - at Test head coaxial terminal, 123, 137
 - open compensation
 - Basic Operations, 67
 - overview, 116
 - open compensation data
 - How to measure, 129, 140
 - Open standard value
 - Names and Functions of Display Areas, 94, 96
 - OPEN/SHORT Compensation
 - , 270
 - OPEN/SHORT/LOAD Calibration
 - Measurement Support Functions, 270
 - Operation environment
 - installation guideline, 20
 - Operation Manual
 - contents, 18, 280
 - Option 004, 281
 - Characteristics, 281
 - contents, 19, 280
 - Option 010
 - Mass Storage, 271
 - Option 011
 - Mass Storage, 271
 - Option 020
 - contents, 19, 280
 - Option 1CM
 - contents, 19, 280
 - How to Install, 24
 - Option 1CN
 - contents, 19, 280
 - How to Install, 22
 - Option 1CP
 - contents, 19, 280
 - How to Install, 26
 - Option ABJ
 - contents, 18, 280
 - Option plate, 81
 - ORIENTATION [LANDSCAPE]
 - Printing, 317
 - ORIENTATION [PORTRAIT]
 - Printing, 317
 - oscillator level
 - How to chang, 110
 - How to change setup unit, 111
 - setting resolution, 112
 - Source characteristics, 253
 - Oscillator level setup unit
 - Names and Functions of Display Areas, 92
 - Oscillator level(power)
 - Names and Functions of Display Areas, 86
 - Out, 185
 - OUT OF GOOD BINS
 - Example of Settings for BIN Sorting, 202
 - setting, 187
 - OUT OF GOOD BINS line
 - Example of Settings for BIN Sorting, 202
 - Names and Functions of Display Areas, 98
 - Output Impedance
 - Source characteristics, 255
 - Outside, 185
 - Overload
 - Operations when errors occur, 312
 - overloads (Ovld)
 - statistical analysis parameter, 206
 - Ovld
 - equipment status display, 87
- P**
- Parameter
 - Definition, 256
 - Pass or Fail
 - BIN sort result beep sound, 234
 - PCNT
 - Limit mode, 181
 - Percentage mode
 - Limit mode, 181
 - setting reference value, 182
 - Port extension compensation
 - How to carry out, 127
 - Measurement Support Functions, 270
 - overview, 116
 - POWER
 - Selection of Display Parameters, 162
 - Power
 - cutting off the power supply, 39
 - turning on and off, 38
 - Power Cable
 - contents, 18, 280
 - Power cable receptacle, 79
 - Power requirements
 - General Characteristics, 276
 - power supply
 - check the requirements, 35
 - power cable options, 36
 - preparation, 35
 - Verification and connection of power cable, 35
 - [Preset]
 - Basic Operations, 54
 - [Preset] key
 - function, 77
 - initialize, 102
 - Presetting
 - Basic Operations, 54
 - Printer model

-
- selecting, 317
 - Printing
 - Procedure, 316
 - Selecting the contents, 316
 - starting and stopping, 318
 - [Prmtr] key
 - function, 76
 - Professional Setup wizard, 40
 - Programming Manual
 - contents, 18, 280
 - Q**
 - Q**
 - BIN sort measurement parameter, 179
 - Selection of Measurement Parameters, 160
 - Quality factor
 - BIN sort measurement parameter, 179
 - Selection of Measurement Parameters, 160
 - R**
 - R**
 - Selection of Measurement Parameters, 160
 - R_dc
 - Selection of Display Parameters, 162
 - Rack Mounting Flanges
 - How to Install, 22
 - Rackmount & Handle Kit
 - contents, 19, 280
 - How to Install, 26
 - Rackmount Kit
 - contents, 19, 280
 - How to Install, 24
 - Rdc
 - measurement precautions, 47
 - Rdc Limit Check, 151
 - Rdc limit deviation
 - Operations when errors occur, 312
 - Rdc limit deviations
 - statistical analysis parameter, 206
 - Rdc measurement
 - Offset cancel function, 113
 - On/Off, 113
 - Rdc measurement time, 266
 - Rdc upper and lower limit values
 - Names and Functions of Display Areas, 97
 - /RDC_OUT_OF_RANGE, 188
 - Rear Panel
 - Names and Functions, 79
 - Recovery, 285
 - Reference Value
 - Concept of BIN sort setting, 175
 - setting, 182
 - Registration, 40
 - Relative humidity
 - Operation environment, 20
 - Reserved ports, 81
 - Rotary knob
 - function, 75
 - Rp**
 - BIN sort measurement parameter, 179
 - Selection of Measurement Parameters, 160
 - Rs**
 - BIN sort measurement parameter, 179
 - Selection of Measurement Parameters, 160
 - S**
 - Safety
 - General Characteristics, 276
 - safety
 - symbols, 4
 - safety summary, 3
 - Sample Program Disk
 - contents, 18, 280
 - [Save/Recall] key
 - function, 76
 - Screen Display
 - hiding, 166
 - Saving, 216
 - section titles, 45
 - Serial number plate, 81, 284
 - Setting Status
 - Saving, 214
 - setup display, 82
 - Setup display exit button
 - Names and Functions of Display Areas, 92
 - Setup display menu bar
 - Names and Functions of Display Areas, 91
 - SETUP IP ADDRESS, 287
 - [Setup View]
 - How to bring up the measurement point setup display, 103
 - [Setup View] key
 - function, 75
 - short calibration
 - Basic Operations, 58
 - overview, 116
 - short calibration data
 - How to measure, 144
 - at DUT connection terminal, 133
 - at Test head coaxial terminal, 124, 137
 - short compensation
 - Basic Operations, 66
 - overview, 116
 - short compensation data
 - How to measure, 130, 140
 - Short standard value
 - Names and Functions of Display Areas, 94, 96
 - shutdown,
 - power, 38
 - Single Point Measurement
 - Details of Measurement Time, 264
 - measurement time example, 267
 - Selecting, 157
 - Single point measurement display
 - Function, 82

- Names and Functions of Display Areas, 84
 - SMA(f)-SMA(f) Adapter
 - contents, 19, 280
 - Softkey menu name
 - Names and Functions of Display Areas, 86
 - Softkeys
 - Names and Functions of Display Areas, 87
 - Sorting condition, 177
 - Names and Functions of Display Areas, 98
 - Source characteristics
 - Basic Measurement Characteristics, 253
 - Speaker
 - Setting, 233
 - Specifications, 251
 - spurious characteristics, 258
 - sta, 214
 - Standard Deviation (SD)
 - statistical analysis parameter, 206
 - Stand-by switch, 74
 - Statistical Analysis, 206
 - Data Logging, 207
 - Executing and Displaying Results, 209
 - parameters, 206
 - Saving the Results, 210
 - [Stml Select] key
 - function, 75
 - Sub Net Mask
 - checking and editing, 287
 - Supplemental Performance Characteristics, 251
 - Svc
 - equipment status display, 87
 - Switching time of setup, 262
 - [System] key
 - function, 76
 - System Recovery
 - How to Execute, 240
 - System recovery, 285
- T**
- Table
 - Setup display menu, 91
 - Table number
 - How to specify, 104
 - Names and Functions of Display Areas, 85, 97
 - Temperature
 - General Characteristics, 275
 - Operation environment, 20
 - Test Fixture
 - about connection, 46
 - connection to the Test Fixture Stand, 66
 - selection guideline, 45
 - Test Fixture Connection
 - Basic Operations, 65
 - Test Fixture Stand
 - connection to the 4287A, 32
 - contents, 18, 280
 - Test Head, 77
 - contents, 18, 280
 - Dimensions, 279
 - How to connect, 31
 - Test Head Extension Cable
 - contents, 19, 280
 - TEST HEAD INTERFACE, 77
 - Test Head Interface, 77
 - Test Ports
 - Maintenance, 330
 - Test signal current level monitor value
 - Names and Functions of Display Areas, 86
 - Selection of Display Parameters, 162
 - Test signal level
 - DC resistance (Rdc) measurement, 270
 - Names and Functions of Display Areas, 92
 - Uncertainty of monitor value, 271
 - Test signal level (power)
 - Selection of Display Parameters, 162
 - Test signal voltage level monitor value
 - Names and Functions of Display Areas, 86
 - Selection of Display Parameters, 162
 - The, 116
 - qy (deg)
 - BIN sort measurement parameter, 179
 - qy (rad)
 - BIN sort measurement parameter, 179
 - qz (deg)
 - BIN sort measurement parameter, 179
 - qz (rad)
 - BIN sort measurement parameter, 179
 - theta z (deg)
 - Selection of Measurement Parameters, 160
 - theta z (rad)
 - Selection of Measurement Parameters, 160
 - theta z(rad)
 - Selection of Measurement Parameters, 160
 - Throughput
 - Improvement of Measurement Throughput by Screen Display Settings, 309
 - time
 - setting the date/time, 43
 - setting the internal clock, 290
 - time zone
 - setting, 289
 - Timing Chart
 - Handler Interface, 261
 - Title
 - Names and Functions of Display Areas, 84
 - Total number of measurements (All)
 - statistical analysis parameter, 206
 - Trigger delay time, 266
 - Trigger function
 - Measurement Support Functions, 271
 - [Trigger] key
 - function, 76
 - [Trigger Mode] key
 - function, 76

typeface conventions, 6

U

UnCal

equipment status display, 87

unit keys

function, 77

UPDATE DISPLAY, 167

Update the LCD Display View

turning ON/OFF, 167

Upper limit value, 183

Concept of BIN sort setting, 175

DC resistance(Rdc), 188

V

Ventilation space

required ventilation space at installation site, 20

Vertical scroll bar

Names and Functions of Display Areas, 90

VGA connector, 80

Vibration

General Characteristics, 275

VIDEO, 80

View

Setup display menu, 91

V-mon

Selection of Display Parameters, 162

W

Warm-up time

General Characteristics, 275

warning beep

ON or OFF, 233

warranty, 5

limitation of, 5

Weight

General Characteristics, 276

Windows 2000, 40

Wrench

contents, 18, 280

X

X

BIN sort measurement parameter, 179

Selection of Measurement Parameters, 160

Y

|Y|

BIN sort measurement parameter, 179

Selection of Measurement Parameters, 160

Z

|Z|

BIN sort measurement parameter, 179

Selection of Measurement Parameters, 160