

Operation and Service Guide

Agilent Technologies 8648A/B/C/D Signal Generator

Serial Number Prefixes:

This manual applies directly to the following model/serial prefix combinations and below.

8648A	8648B	8648C	8648D
3847A/U	4037A/U	4037A/U	4037A/U



Part Number 08648-90048

Printed in USA

March 2001

Supersedes September 2000

© Copyright 1996, 1998-2001 Agilent Technologies, Inc.

WEEE Directive



This product complies with the WEEE Directive (2002/96/EC) marking requirements. The affixed label indicates that you must not discard this electrical/electronic product in domestic household waste.

Product Category: With reference to the equipment types in the WEEE Directive Annex 1, this product is classed as a “Monitoring and Control instrumentation” product.

Do not dispose in domestic household waste.

To return unwanted products, contact your local Agilent office, or see <http://www.agilent.com/environment/product/> for more information.



Contents

1. Operation

Quick Overview	1-2
1. Power Key	1-2
2. Display	1-2
3. Function and Data Keys	1-3
4. Increment Set Keys	1-4
5. Knobs	1-4
6. MEMORY	1-4
7. Modulation Source	1-5

1a. Operation Examples

Setting the RF Output Signal	1a-3
Setting the Frequency	1a-3
Setting the Amplitude	1a-3
Turn on the RF Output	1a-3
Setting the Modulation	1a-4
Incrementing or Decrementing the RF output Signal	1a-5
Preliminary Steps	1a-5
Using the Knob	1a-5
Using the Increment Keys	1a-5
Using the Memory Registers	1a-7
Saving Instrument Setting in Register Sequences	1a-8
Deleting a Register from the Sequence	1a-11
Renumbering the Registers in a Sequence	1a-12
Inserting a Register in a Sequence	1a-13
Offsetting the RF Output from a Reference	1a-16
Setting the Reference Value	1a-16
Offsetting the RF Output	1a-17
Holding the Output Attenuator Range	1a-19
Set the Amplitude Level	1a-19
Holding the Attenuator	1a-19
Adjusting the Amplitude	1a-20
Setting a User Selectable Modulated Frequency and Waveform (Option 1E2 or 1EP Only)	1a-21
Setting the Modulation Level	1a-21
Setting the Modulated Waveform	1a-21
Setting the Modulated Frequency	1a-22
Signaling a Numeric-Type FLEX Pager (Option 1EP Only)	1a-23
Setting Up Pager Encoding	1a-23
Entering Pager Encoding Settings	1a-24
Selecting the Format Settings	1a-24
Selecting the Data Rate and Pager Type Settings	1a-25
Selecting the Message Settings	1a-26
Selecting the Transmission Repetitions and Amplitude	1a-26
Selecting the Pager Capcode (Address)	1a-27
Selecting the Protocol Settings	1a-28
Selecting the Roaming Mode Settings	1a-29
Encoding	1a-29

Contents

1b. Operation Reference

Frequency and Amplitude.	1b-2
1. Knob	1b-2
2. Digit-Select Arrow Keys.	1b-2
3. REF SET.	1b-2
4. REF ON/OFF	1b-3
Function.	1b-4
1. FREQUENCY.	1b-4
2. AMPLITUDE	1b-5
3. FM, AM, Φ M.	1b-5
Setting Up the Pager Encoder.	1b-6
Pulse Modulation	1b-29
Increment Set.	1b-31
Data.	1b-32
Instrument Preset	1b-34
GPIB	1b-38
Memory.	1b-39
Modulation Source	1b-43
RF Output.	1b-47
Rear Panel.	1b-49
Remote Interface (Accessory).	1b-51
Memory Interface (Accessory)	1b-53

1c. Operation messages

Front Panel Operation Messages	1c-2
GPIB Command Messages	1c-5
GPIB Execution Errors	1c-8
GPIB Device-Specific Errors.	1c-9
GPIB Query Errors	1c-10
Service Messages	1c-11

2. GPIB Programming

Background	2-1
Programming Guidelines	2-2
GPIB Definition	2-2
What is Programmable	2-2
GPIB Address	2-2
Error Messages.	2-2
Programming Language	2-2
Query.	2-2
Advanced Programming.	2-2
Programming Examples	2-3
Programming RF Frequency	2-3
Programming RF Frequency and FM Modulation.	2-3
Querying RF Frequency.	2-4
Programming RF Amplitude	2-4
Programming Pulse Modulation (Option 1E6)	2-4
Programming Pager Encoder (Option 1EP)	2-5

Contents

GPIB Status Reporting	2-12
External Modulation Input Level Status.	2-14
Reverse Power Protection Status.	2-16
Unspecified Power (Amplitude) Entry Status	2-17
Pager Encoding Status (Option 1EP Only)	2-18
SCPI Command Reference.	2-20
ABORt Subsystem (Option 1EP Only).	2-21
AM Subsystem.	2-21
CAL Subsystem.	2-22
DM Subsystem (Option 1EP Only)	2-22
FM Subsystem.	2-23
FREQuency Subsystem	2-24
INITiate Subsystem (Option 1EP Only)	2-24
OUTPut Subsystem	2-24
PAGing Subsystem (Option 1EP Only)	2-25
PM Subsystem.	2-37
POWer Subsystem.	2-38
PULM Subsystem	2-38
STATus Subsystem.	2-39
SYSTem Subsystem	2-40
TRIGger Subsystem (Option 1EP Only)	2-40
Changing Parameters While Encoding (Option 1EP Only)	2-41
Using the Buffer Memory for the Arbitrary Messages.	2-41
GPIB Capabilities.	2-43
GPIB Connector Information.	2-44
8656/57 Compatible Language	2-45
Program Code Implementation	2-46
Receiving the Clear Message	2-48
Additional Programming Information.	2-48

3. Installation

Unpacking Your Signal Generator	3-2
Connecting AC Power.	3-3
Power Requirements.	3-3
Replacing the Fuse	3-3
Turning On the Signal Generator	3-6
Connecting to Other Instruments	3-7
Storing the Signal Generator.	3-8
Shipping the Signal Generator	3-9

4. Specifications

Options	4-1
Option Specifications	4-1
Frequency Specifications	4-2
Internal Reference Oscillator	4-2
Output.	4-3
Spectral Purity	4-4
Frequency Modulation	4-5

Contents

Phase Modulation	4-6
Amplitude Modulation	4-7
Modulation Source	4-8
Remote Programming	4-8
Environmental	4-9
General	4-9
Modulation Generator Option 1E2	4-10
Pulse Modulation Option 1E6	4-11
Pager Encoder/Signalling Option 1EP	4-11
Frequency Modulation	4-12
Paging Signaling	4-12
Modulation Source	4-12
General	4-12
Regulatory Information	4-13
ISO 9002 Compliant	4-13
Statement of Compliance	4-13
Noise Declaration	4-13
5. Service	
Shipping Your Instrument Back to Agilent Technologies	5-2
Recommended Test Equipment	5-3
Post-Repair	5-6
Safety Notes	5-9
5a. Theory of Operation	
Overview	5a-4
A1 Front Panel	5a-5
A2 Power Supply	5a-7
A3 Motherboard	5a-8
A4 Reference	5a-9
A5 Sig Gen Synth	5a-10
A6 Output (8648A)	5a-11
A6 Output (8648B/C/D)	5a-12
A7 Attenuator (8648A)	5a-13
A10 Frequency Extension (8648B/C/D)	5a-14
A11 Attenuator (8648B/C/D)	5a-15
A12 Reverse Power Protection(8648B/C/D)	5a-16
A13 Pulse Modulator (8648B/C/D Option 1E6)	5a-17
A14 Modulation Generator (Option 1E2)	5a-18
A30 Pager Encoder (8648A Option 1EP)	5a-19
5b. Troubleshooting Information	
Troubleshooting Checklist	5b-2
AC Mains (Line) Fuse Removal	5b-3
To Remove the Fuse	5b-3
Modulation Test Points and Power Supply LEDs	5b-4
Power Supply Distribution	5b-5

Contents

5c. Service Error Messages

6. Replaceable Parts

Assembly Replacements	6-1
8648A Replaceable Parts	6-3
8648B/C/D Replaceable Parts	6-9

7. Adjustments

Test Equipment	7-2
Equipment Setup for Automated Tests	7-2
Test Point Extender	7-2
Manual Adjustments	7-4
Internal Reference Oscillator Adjustment	7-5
Pager Encoder Timebase Frequency Adjustment	7-7
Automated Adjustments	7-9
AM Level and Distortion (8648A Only)	7-10
AM Level (8648B/C/D Only)	7-12
Detector Offset (8648A Only)	7-14
Output Level (8648A Only)	7-15
AM Level: FE (8648B/C/D Only)	7-16
Predistortion and Detector Offset (8648B/C/D Only)	7-18
Prelevel (8648B/C/D Only)	7-19
Output level: Frequency Extension Calibration (8648B/C/D Only)	7-20
AM Modulator (8648A Only)	7-21
Time Base DAC (All 8648A/B/C/D)	7-23
Motherboard Audio Path (All 8648A/B/C/D)	7-24
DCFM (All 8648A/B/C/D)	7-26
Audio Generator (Options 1E2 and 1EP Only)	7-27
HF Power Level Accuracy (All 8648A/B/C/D)	7-28
LF Output Level (Most 8648B/C/D)	7-31
LF Power Level Accuracy (Most 8648B/C/D)	7-32
FSK Deviation (Option 1EP Only)	7-34
Filter Path (Option 1EP Only)	7-35
Agilent Service Support Software	7-36
Required Test Equipment	7-36
Installing the Software	7-37
Uninstalling the Software	7-41
Service Support Software Administration	7-42
Running the Service Support Software	7-53
Motherboard Repair Utility	7-58

8. Performance Tests

Calibration Cycle	8-2
Required Test Equipment	8-3
Performance Test Descriptions	8-6
Manual Performance Tests	8-6
Automated Performance Tests	8-6
FM Accuracy Performance Test	8-7

Contents

Connect the Test Equipment	8-7
Configure the Measuring Receiver	8-7
Configure the 8648	8-7
Measure Deviations	8-7
Test Record	8-7
8648B/C/D Only	8-8
Connect the Test Equipment	8-8
Configure the Synthesized Signal Generator	8-8
Measure Deviations	8-8
Test Record	8-9
FM Accuracy Performance Test (Option 1E2 Only)	8-10
Connect the Test Equipment	8-10
Configure the Measuring Receiver	8-10
Configure the 8648	8-10
Measure Deviations	8-10
Test Record	8-11
8648B/C/D Option 1E2 Only	8-11
Connect the Test Equipment	8-11
Configure the Synthesized Signal Generator	8-11
Measure Deviations	8-12
Test Record	8-12
FM Distortion Performance Test	8-13
Connect the Test Equipment	8-13
Configure the Measuring Receiver	8-13
Configure the Audio Analyzer	8-13
Configure the 8648	8-13
Measure Distortion	8-14
Test Record	8-14
8648B/C/D Only	8-14
Connect the Test Equipment	8-14
Configure the Synthesized Signal Generator	8-15
Measure Deviations	8-15
Test Record	8-15
AM Accuracy Performance Test	8-16
Connect the Test Equipment	8-16
Configure the Measuring Receiver	8-16
Configure the 8648	8-16
Measure Depths	8-16
Test Record	8-16
AM Accuracy Performance Test (Option 1E2 Only)	8-17
Connect the Test Equipment	8-17
Configure the Measuring Receiver	8-17
Configure the 8648	8-17
Measure Depths	8-17
Test Record	8-18
AM Distortion Performance Test	8-19
Connect the Test Equipment	8-19
Configure the Measuring Receiver	8-19
Configure the Audio Analyzer	8-19

Contents

Configure the 8648	8-19
Measure Distortion Amplitudes	8-20
Test Record	8-20
Phase Modulation Distortion Performance Test	8-21
Connect the Test Equipment	8-21
Configure the Measuring Receiver	8-21
Configure the Audio Analyzer	8-21
Configure the 8648	8-21
Measure Distortion	8-22
Test Record	8-22
8648B/C/D Only	8-22
Connect the Test Equipment	8-22
Configure the Synthesized Signal Generator	8-23
Measure Deviations	8-23
Test Record	8-23
Residual FM Performance Test	8-24
Connect the Test Equipment	8-24
Configure the Measuring Receiver	8-24
Configure the Audio Analyzer	8-25
Configure the Synthesized Signal Generator	8-25
Configure the 8648	8-25
Measure Deviations	8-25
Test Record	8-25
Harmonics Performance Test	8-26
Connect the Test Equipment	8-26
Configure the Spectrum Analyzer	8-26
Configure the 8648	8-26
Measure Harmonic Levels	8-26
Test Record	8-26
Spurious Performance Test	8-27
Connect the Test Equipment	8-27
Configure the Spectrum Analyzer	8-27
Configure the 8648	8-27
Measure Spurious Levels	8-27
Test Record	8-27
DC FM Frequency Error Performance Test	8-28
Connect the Test Equipment	8-28
Configure the Frequency Counter	8-28
Configure the 8648	8-28
Measure Deviations	8-28
Test Record	8-29
RF level Accuracy Performance Test	8-30
Description	8-30
Connect the Test Equipment	8-30
Configure the Measuring Receiver	8-30
Configure the 8648	8-31
Measure Amplitudes	8-31
Test Record	8-31
8648B/C/D Only	8-31

Contents

Connect the Test Equipment	8-32
Configure the Power Meter	8-32
Configure the 8648B/C/D	8-32
Measure High Level Power Accuracy (≤ 13 dBm)	8-32
Test Record	8-32
Configure the 8648 Option 1EA	8-33
Measure the High Power Level Accuracy	8-33
Test Record	8-34
Configure the Power Meter	8-34
Measure Low Level Power accuracy (< -20 dBm)	8-34
Test Record	8-34
Pulse Modulation On/Off Ratio Performance Test (Option 1E6 Only)	8-35
Connect the Test Equipment	8-35
Configure the Spectrum Analyzer	8-35
Configure the 8648	8-35
Measure the On/Off Ratio	8-36
Test Record	8-36
Pulse Modulation Rise Time Performance Test (Option 1E6 Only)	8-37
Connect the Test Equipment	8-37
Configure the Pulse Generator	8-37
Configure the 8648	8-37
Configure the Oscilloscope	8-37
Measure the Rise Time	8-38
Test Record	8-38
Pager Encoder Timebase Accuracy Performance Test (Option 1EP Only)	8-39
Connect the Test Equipment	8-39
Configure the Frequency Counter	8-39
Configure the 8648	8-39
Measure the Frequency	8-39
Test Record	8-39
FSK Deviation Accuracy Performance Test (Option 1EP Only)	8-40
Connect the Test Equipment	8-40
Configure the Vector Signal Analyzer	8-40
Configure the 8648	8-42
Measure FSK Deviation	8-43
Test Record	8-45
Internal Timebase: Aging Rate Performance Test (Option 1E5 Only)	8-46
Description	8-46
Connect the Test Equipment	8-47
Configure the Oscilloscope	8-47
Measure the Phase Change Time	8-48
Test Record	8-48
Power Level Accuracy Performance Test (Automated)	8-49
Description	8-49
Required Test Equipment	8-49
Procedure	8-49
8648A Test Record	8-52
8648B Test Record	8-72
8648C Test Record	8-96

8648D Test Record	8-122
-------------------------	-------

9. Supplemental Verification Tests

Required Test Equipment List	9-2
CW Frequency Accuracy Supplemental Verification Test	9-3
Connect the Test Equipment	9-3
Configure the Frequency Counter	9-3
Configure the 8648	9-3
Measure Frequency Accuracy	9-3
Test Record	9-4
9 kHz RF Level Accuracy Supplemental Verification Test	9-8
Connect the Test Equipment	9-8
Configure the Multimeter (DMM)	9-8
Configure the 8648	9-8
Measure RF levels	9-8
Test Record	9-9

1 Operation

“Operation” contains the following information:

- 1. Operation: Provides a quick overview of the instrument’s operation.
- 1a. Operation Examples: provides examples to help you learn how to operate the instrument.
- 1b. Operation reference: Provides quick access to information about each of the instrument’s functions.
- 1c. Operation Messages: Provides information about both front panel and GPIB remote operation messages.

NOTE For Information about service messages numbered 500 and above, refer to Chapter 5c, “Service Error Messages”.

Quick Overview

Figure 1-1. The 8648 Signal Generator

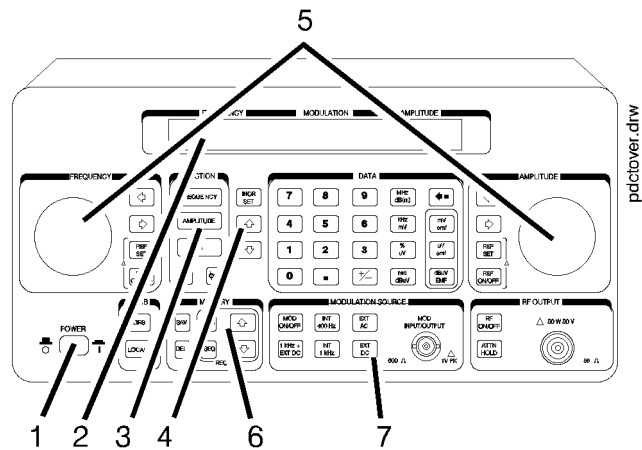

1. Power Key

Press **POWER** to power up the instrument. The instrument powers up to the same state it was in when power was turned off, except that the RF output will be turned off and the digit-select arrow keys (\leftarrow and \rightarrow) will be reset to the least significant digit.

2. Display

The display can be one of two displays depending on the serial number prefix of your instrument as illustrated below.

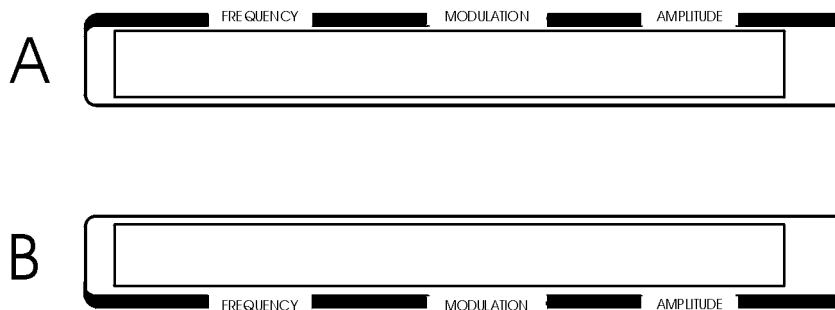

of77a

The following table describes the prefixes that apply to the various 8648 models equipped with an LCD.

A. Liquid Crystal Display (LCD) (labels located above the display)			
8648A Prefix	8648B Prefix	8648C Prefix	8648D Prefix
3636A and below	3623A and below	3623A and below	3613A and below
3643U and below	3642U and below	3642u and below	3642U and below

The display contrast of the LCD can be achieved using the adjustment that is located on the rear panel of these instruments. Note that this adjustment is only available for instruments equipped with an LCD. It allows you to adjust the contrast of the LCD. Turn the adjustment to optimize the display for viewing from most angles. If the display is blank, first attempt to adjust the display contrast before returning the instrument for service.

The following table describes the prefixes that apply to the various 8648 models equipped with a VFD.

A. Vacuum Fluorescent Display (VCD) (labels located below the display)			
8648A Prefix	8648B Prefix	8648C Prefix	8648D Prefix
3636A and above	3623A and above	3623A and above	3613A and above
3643U and above	3642U and above	3642u and above	3642U and above

The VFD is a 2x40 display. The intensity of this display is at 100% and cannot be adjusted.

3. Function and Data Keys

The keys in the FUNCTION and DATA blocks allow you to enter values for setting the frequency, amplitude, and modulation level of the RF output signal.

If Option 1EP is present, the **FM** (ENCODER) key will toggle between pager encoder (ENCODER) mode and FM mode.

If Option 1EP is present and the signal generator is in the ENCODER mode, the **rad dB μ V** key functions as a SHIFT key. This key lets you input alphabetical characters using the DATA and MODULATION SOURCE blocks when you are in pager encoder mode.

If Option 1EP is present and the signal generator is in the ENCODER mode, the **MHz dB(m)** key functions as an ENTER key. The ENTER key must be used to store any numeric or alphabetic characters entered by way of the DATA and MODULATION source blocks.

4. Increment Set Keys

When you press a FUNCTION key, that function becomes the active function. Press **INCR SET** to view or change the increment value for the active function. Press \uparrow or \downarrow at any time to change the active function setting by the increment value. (If Option 1EP is present and the signal generator is in the ENCODER mode, these keys have alternate functions.)

If Option 1EP is present and the signal generator is in the ENCODER mode, the **INCR SET** key functions as a START/STOP key. This key starts or stops any pager encoding activity. In addition, in this mode, the \uparrow and \downarrow function as PREV and NEXT keys. These keys let you move the blinking cursor between each parameter when you are entering the pager encoding settings.

5. Knobs

The knobs are always active when the instrument is in local (front panel) control. Turn them to increase or decrease the frequency or the amplitude of the RF output. Press \Leftarrow or \Rightarrow , next to each knob, to adjust the knobs resolution.

Press **REF SET**, next to each knob, to set the displayed value as the reference value and turn on the reference mode. Press **REF ON/OFF** to turn on and off the reference mode without changing the reference value. When the reference mode is on, the displayed value indicates the offset between the reference value and the RF output signal.

If Option 1EP is present and the signal generator is in the ENCODER mode, the AMPLITUDE/ENCODER knob is used to enter a setting for a pager encoding parameter.

6. MEMORY

memory registers allow you to save instrument setups and recall them whenever you wish. Press **SAV** and enter a two-digit register number to save the instrument's current settings. To recall the settings, press **REG** and enter the register number. The arrow keys allow you to recall registers in numerical sequence. You can arrange your registers in up to ten different sequences.

The number of the currently selected sequence and the last register selected are always displayed in the lower-left corner of the display to help you keep track of where you are in your testing process. (If Option 1EP is present, the sequence and register are not displayed on any pager encoding menu.) The memory register examples provided in Chapter 1a, "Operation Examples," show you how to create a sequence and how to delete or add registers in your sequence.

7. Modulation Source

Press **MOD ON/OFF** to turn on or off the modulation source. Press **INT 400 kHz** or **INT 1 kHz** to select one of the internal source tones for modulating the RF output signal. These tones are also available as an output signal at the MOD INPUT/OUTPUT port when they are selected. Press **EXT AC** or **EXT DC** to ac- or dc-couple an external audio source via the MOD INPUT/OUTPUT port.

Press **1kHz + EXT DC** to frequency modulate the RF signal with the internal 1 kHz tone and an external source at the same time. (Additional internal plus external modulation capabilities are available for GPIB operation.) **1kHz + EXT DC** will also amplitude or phase modulate the RF signal with the internal 1 kHz tone but it will not be dc-coupled.

If Option 1EP is present, the **INT 1kHz (FREQUENCY)** key, or if Option 1E2 is present, the **INT 1kHz (FREQUENCY/WAVEFORM)** key scrolls between five states: a fixed 1 kHz internal source and a variable-frequency internal source with four different waveform selections. The four modulation waveforms are sine, triangle, square, and sawtooth (or ramp).

1a Operation Examples

This section contains operating examples to help you learn how to operate the signal generator. These examples can be performed without any additional equipment. The pager testing example can only be performed if Option 1EP is present.

If this is the first time you have operated this instrument, perform each of the following examples for a quick introduction to general operation. After you have completed the examples, try operating the instrument's remaining functions on your own. If you have trouble or want additional information on a function, refer to Chapter 1b, "Operation Reference." If a message is displayed that you do not understand, refer to Chapter 1c, "Operation Messages."

The item numbers of the following operation examples correspond to the numbers called out on drawing of the instrument front panel.

1. Setting the RF Output Signal
2. Incrementing or Decrementing the RF Output Signal
3. Using the Memory Registers
4. Offsetting the RF Output from a Reference
5. Holding the Output Attenuator Range
6. Setting a User Selectable Modulated Frequency and Waveform (Option 1E2 or 1EP Only)
7. Signaling a Numeric-Type FLEX Pager (Option 1EP Only)

Operation Examples

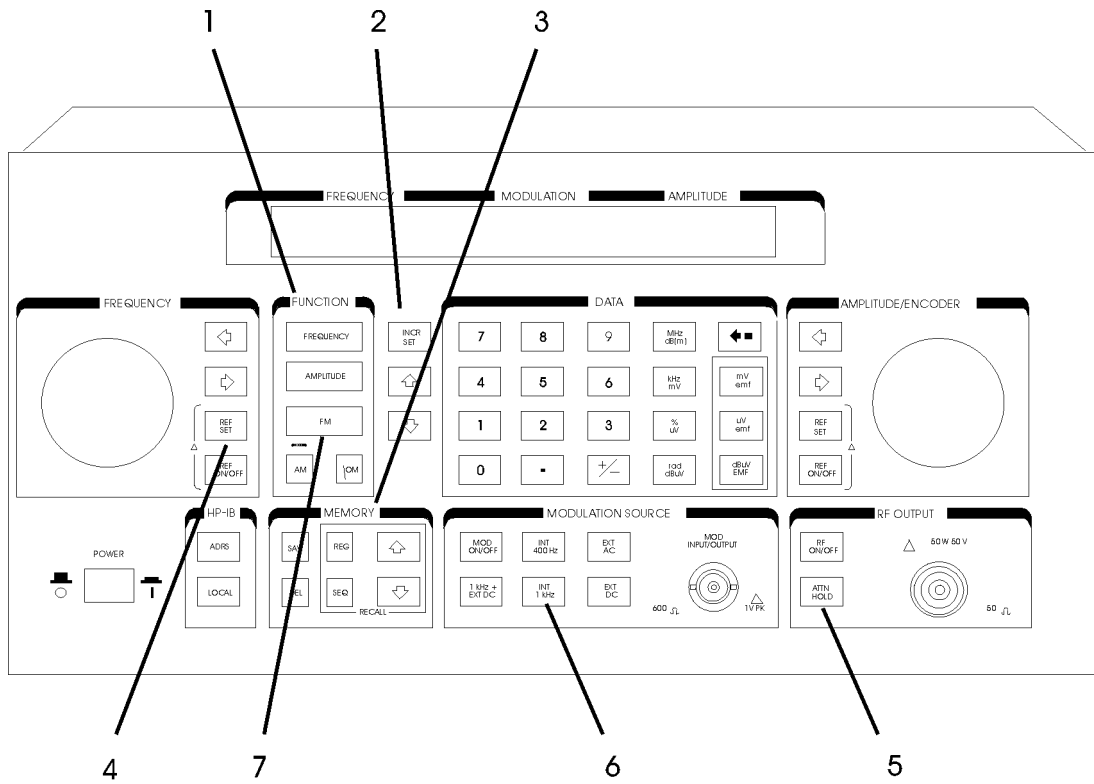

an622a2d

Setting the RF Output Signal

In this example, you will set the frequency, amplitude, and modulation level of the RF output signal.

Setting the Frequency

1. Set the frequency to 100 MHz using the keys shown below the instrument diagram.
If you make a mistake while entering a value, press \leftarrow to correct it.

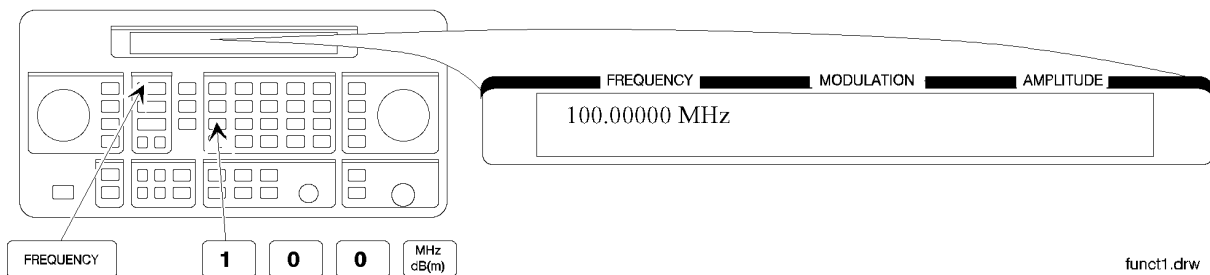

Setting the Amplitude

2. Set the amplitude to -100 dBm.

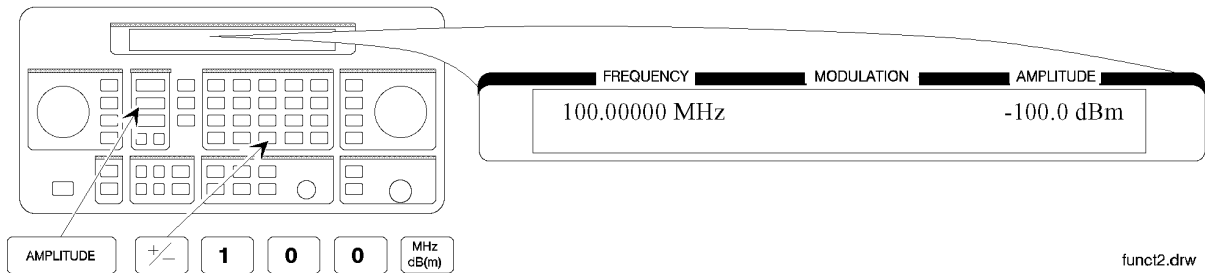

Turn on the RF Output

3. Press RF ON/OFF to turn on the RF output.
RF OFF is displayed below the amplitude setting when the RF output is turned off.

Operation Examples
Setting the RF Output Signal

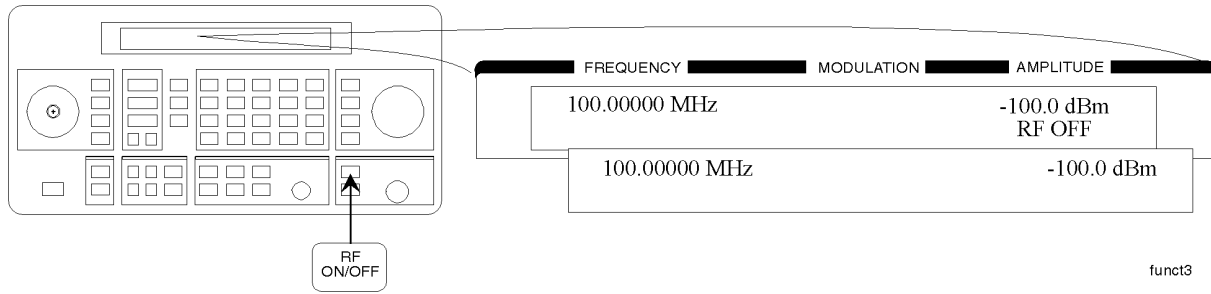

Setting the Modulation

4. Set the FM deviation to 3 kHz.

The modulation rate is displayed below the deviation setting. Use the MODULATION SOURCE keys to select a modulation source and turn modulation on or off.

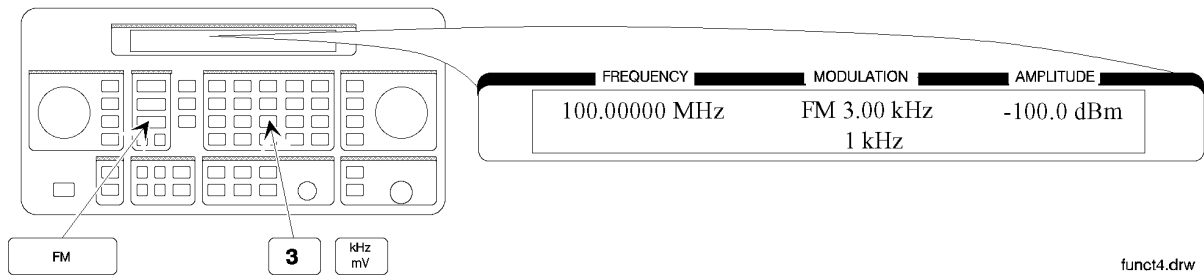

Incrementing or Decrementing the RF output Signal

In this example, you will increment the amplitude and frequency of the RF output signal.

Preliminary Steps

1. If they are not already set, set the frequency to 100 MHz and the amplitude to -100 dBm.

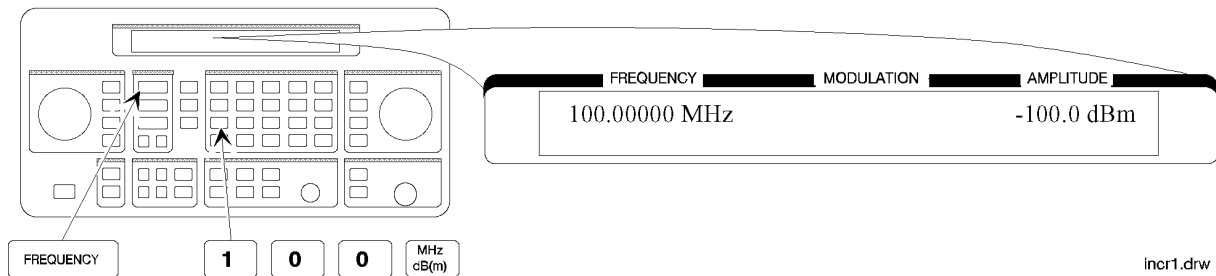

Using the Knob

2. Increment the amplitude using the knob.
Press \leftarrow or \rightarrow when you wish to adjust the increment resolution.

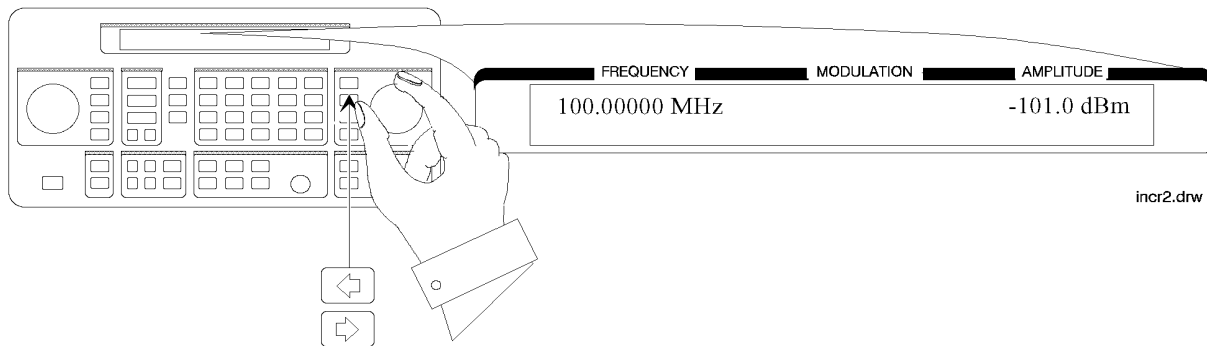

Using the Increment Keys

3. Enter a frequency increment of 25 kHz

The \diamond symbol is displayed when you press INCR SET to indicate that the displayed value is the increment set value.

Operation Examples

Incrementing or Decrementing the RF output Signal

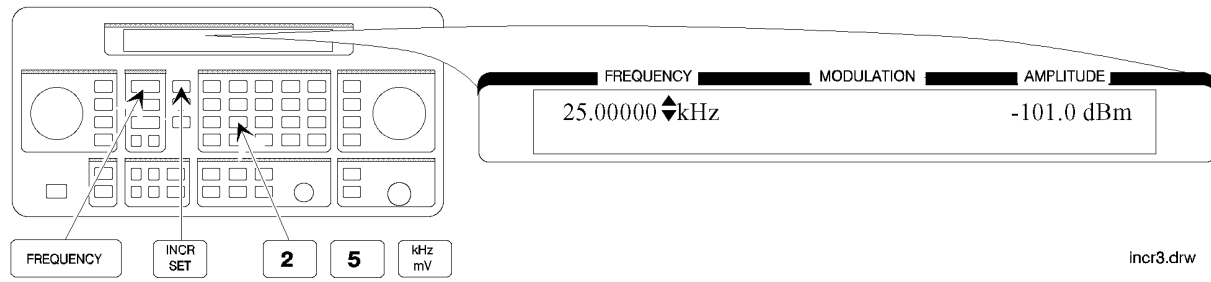

4. Increment the Rf output frequency in 25 kHz steps.

The increment keys affect the last FUNCTION selected (FREQUENCY, AMPLITUDE, FM, AM, OR ϕ M).

Using the Memory Registers

The memory register examples show you how to create a sequence of registers, delete a register from that sequence, renumber the registers in the sequence, and insert a new register in the sequence.

Up to 10 register sequences can be defined (0 through 9). A sequence can contain up to 100 registers (00 through 99). There are a total of 300 registers available in the instrument. The registers can be used in the sequences in any combination (such as 10 sequences of 30 registers each, or 3 sequences of 100 registers each) as long as the total does not exceed 300 registers. It is not possible to have all 10 sequences each contain 100 registers as that would be 1000 registers. (If Option 1EP is present, there are a total of 70 registers available.)

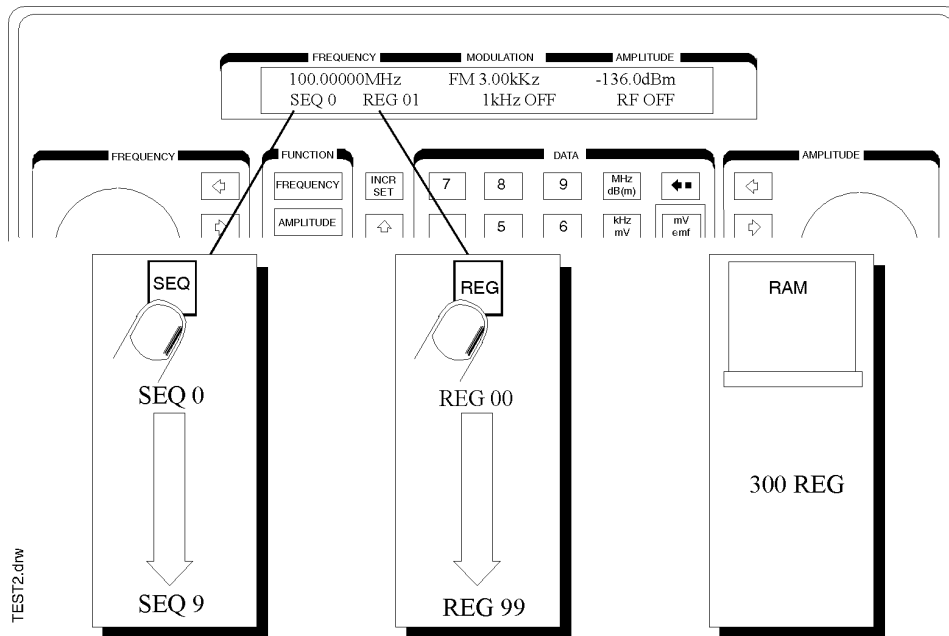

Saving Instrument Setting in Register Sequences

In this ten step example, you will use the memory keys to create a sequence containing three registers. Each register will contain a different frequency setting.

Selecting the Sequence

1. Select sequence 0.

If there are registers saved in sequence 0, the message shown in the display below will not appear. Note that the steps in this example will cause the settings in registers 00, 01, and 02 of sequence 0 to be changed.

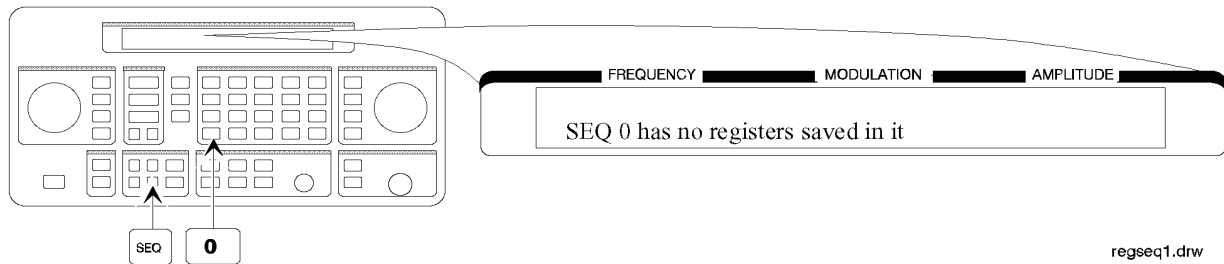

Saving Settings in Registers

2. Set the frequency to 10 MHz.

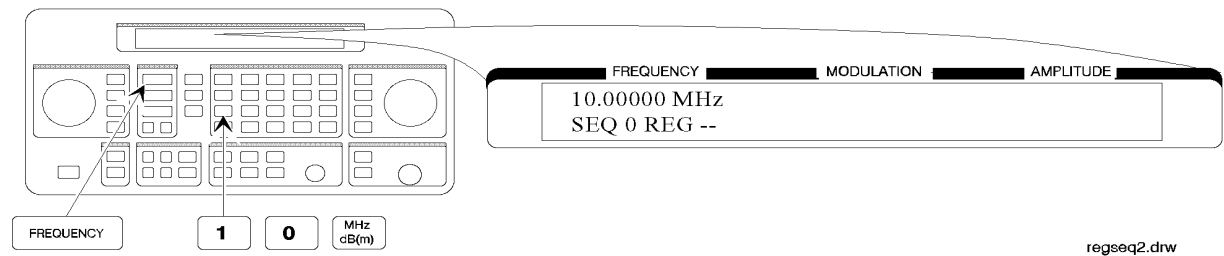

3. Save the instrument settings in register 00.

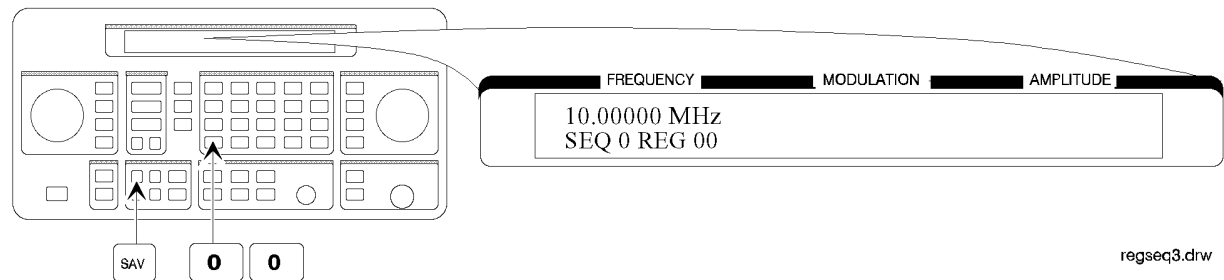

4. Set the frequency setting to 11 MHz.

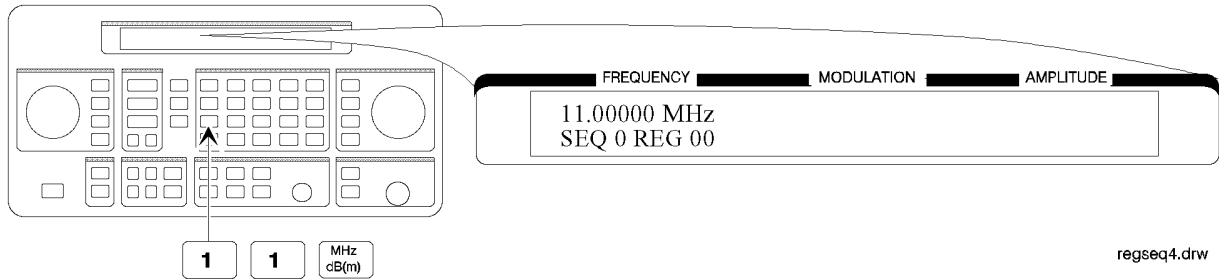

5. Save the instrument settings in register 01.

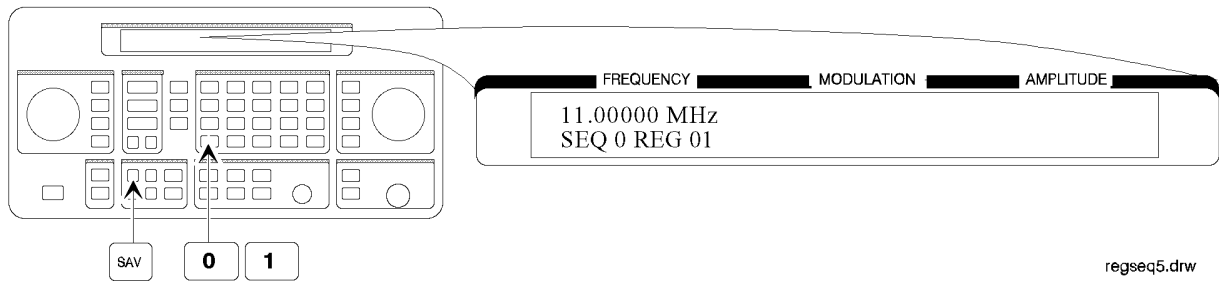

6. Set the frequency to 12 MHz.

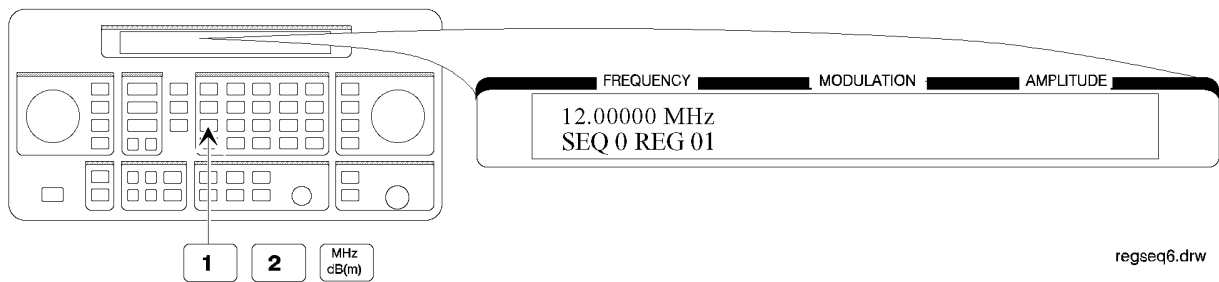

7. Save the instrument settings in register 02.

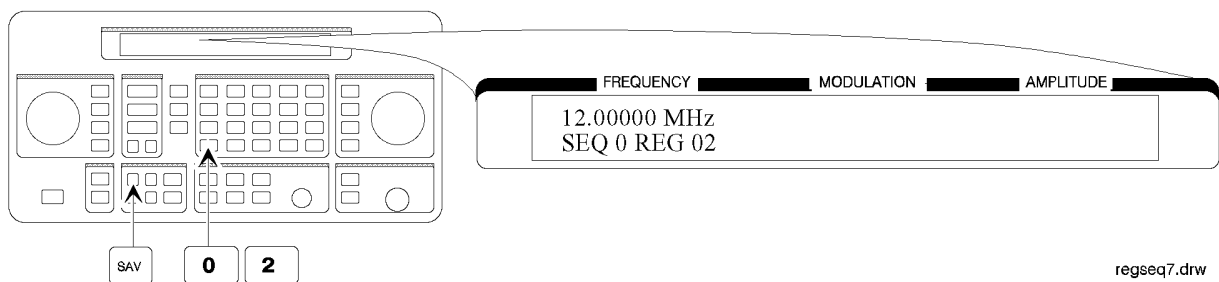

Checking the Sequence

8. Recall the registers in sequence 0.

The \uparrow and \downarrow keys recall registers or sequences depending on which key was pressed last (REG or SEQ).

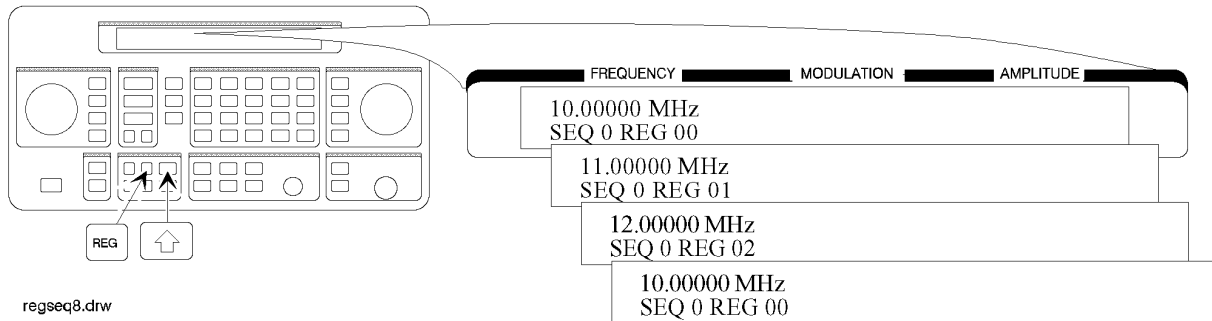

Checking a Different Sequence

9. Select sequence 1.

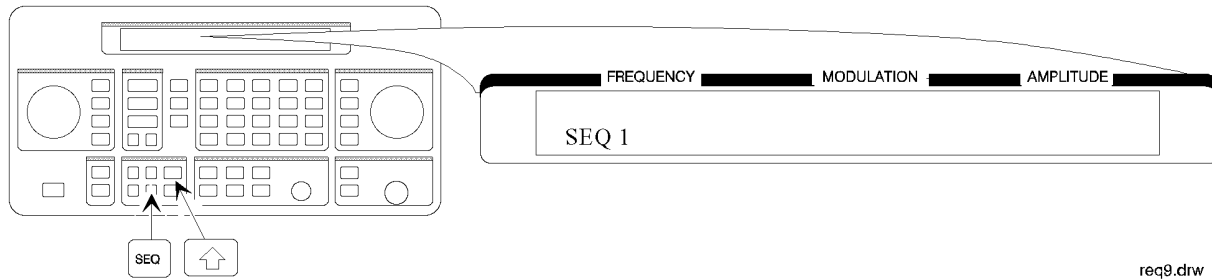

10. Step through the registers in sequence 1 if there are registers saved in it.

NOTE

Sequence 1 does not contain the settings you saved in sequence 0. The instrument enables you to save different settings in each sequence to create up to ten different sequences for your testing. Remember when you save or recall a register, be sure that the correct sequence is also selected.

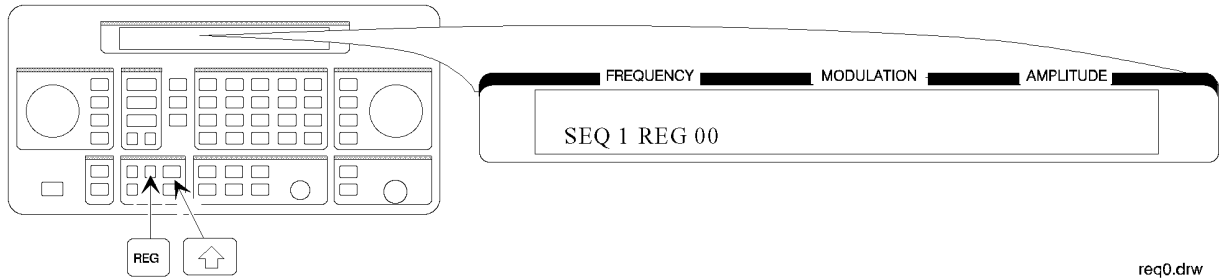

Deleting a Register from the Sequence

In this example, you will delete a register from the sequence you created in the preceding example.

Selecting the Sequence

1. Select sequence 0.

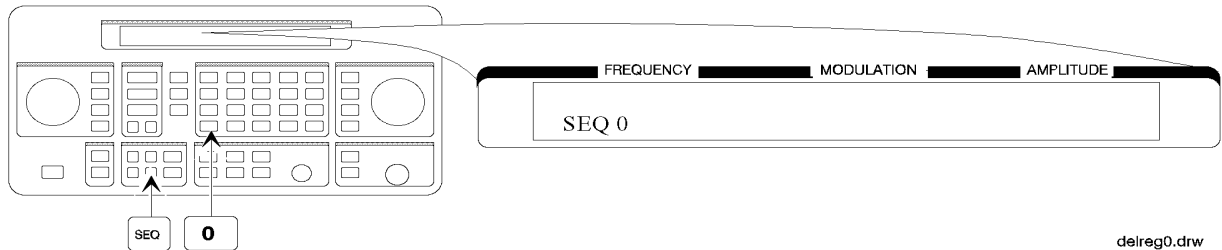

Deleting a Register

2. Delete register 01 from sequence 0.

NOTE The contents of the register are recalled when it is deleted. This allows you to re-save the contents if you need to.

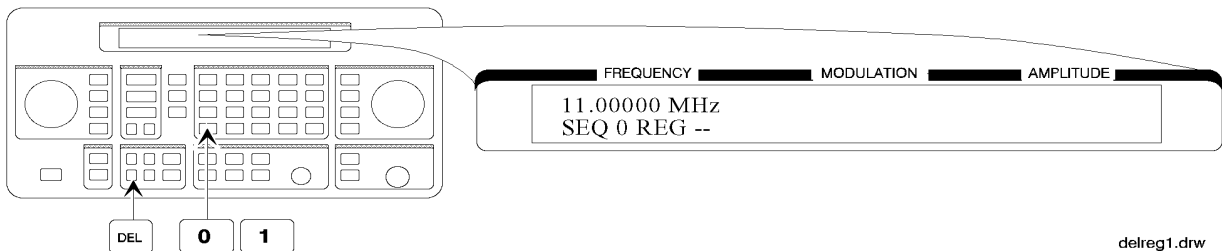

3. Step through the remaining registers in sequence 0.

The deleted register number has been removed from the sequence. Note that the instrument does not renumber the registers when one is deleted.

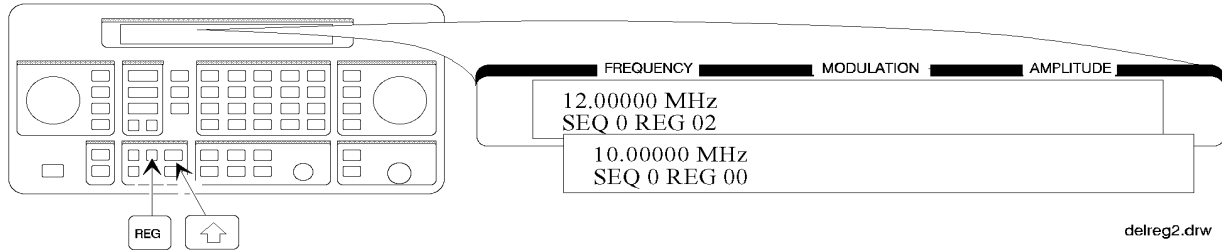

Renumbering the Registers in a Sequence

In this example, you will eliminate the skip from register 00 to register 02 in sequence 0 caused when you deleted register 01 in the previous example.

Decreasing the Register Number

1. Delete register 02.

The settings saved in register 02 are recalled when it is deleted.

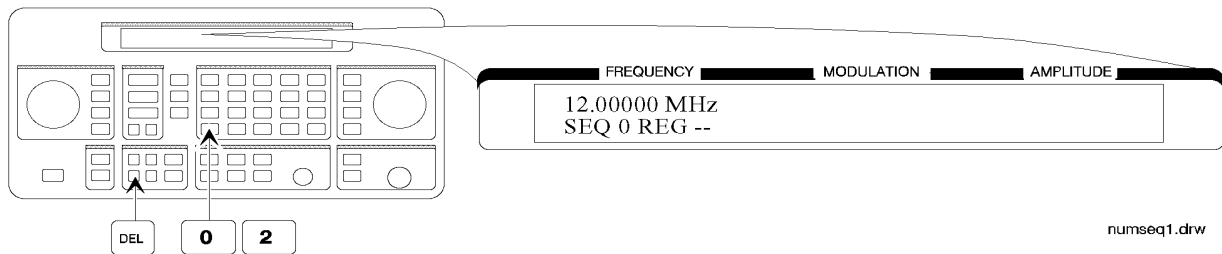

2. Save the settings from register 02 into register 01.

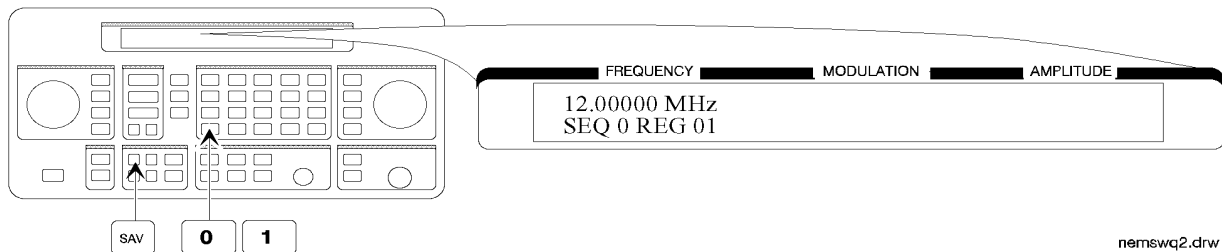

Checking the Sequence

3. Step through the register sequence.

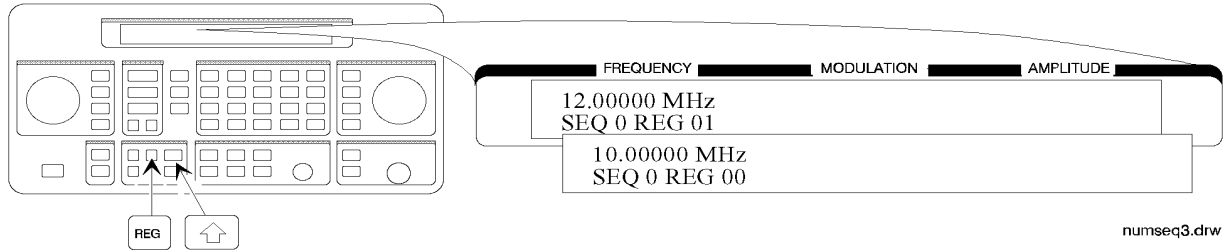

NOTE In this example, you renumbered one register. when you need to renumber two or more registers, use **REG** instead of **DEL** to recall each register until you get to the last register in the sequence, then use **DEL**.

Inserting a Register in a Sequence

In this example, you will insert a register into the sequence you created in the previous example. The process involves incrementing each register number that comes after the point in the sequence where you wish to insert a register.

1. Recall the last register in sequence 0.

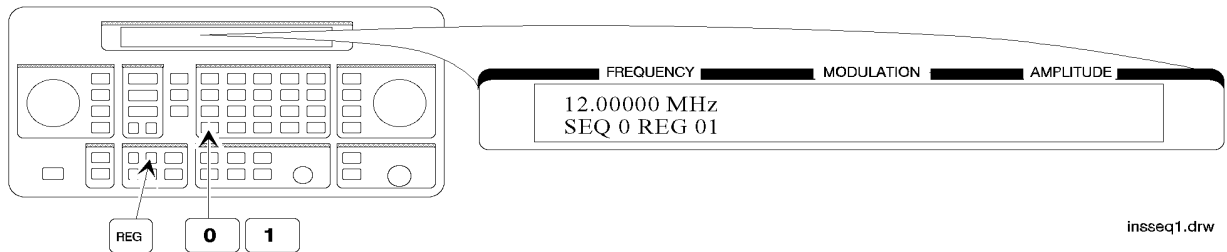

2. Save the recalled settings into register 02.

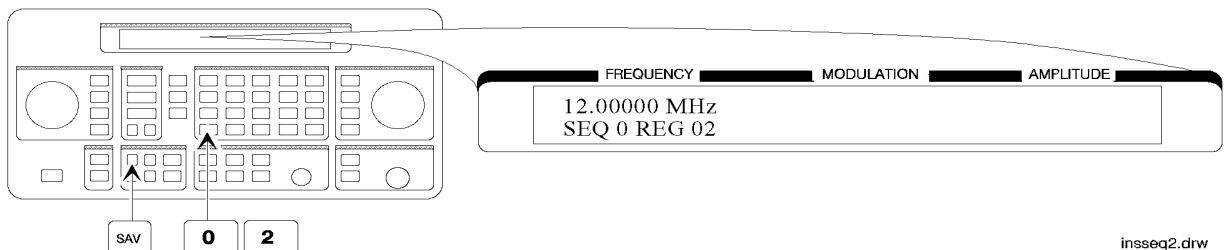

3. Recall register 00.

Register 01 can now be used to save the settings that are saved in register 00.

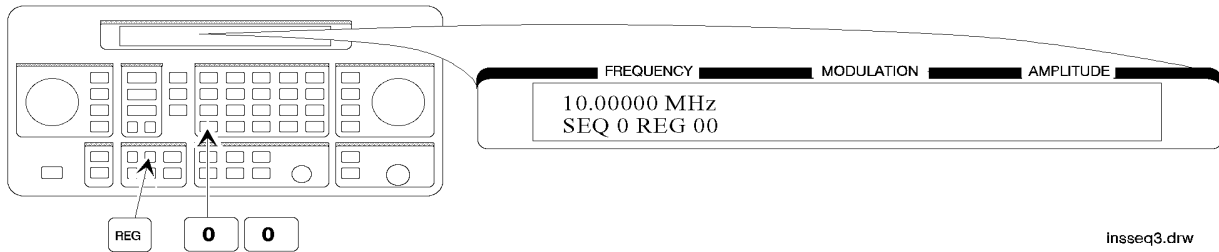

4. Save the recalled settings into register 01.

Register 00 can now be used to save the new settings.

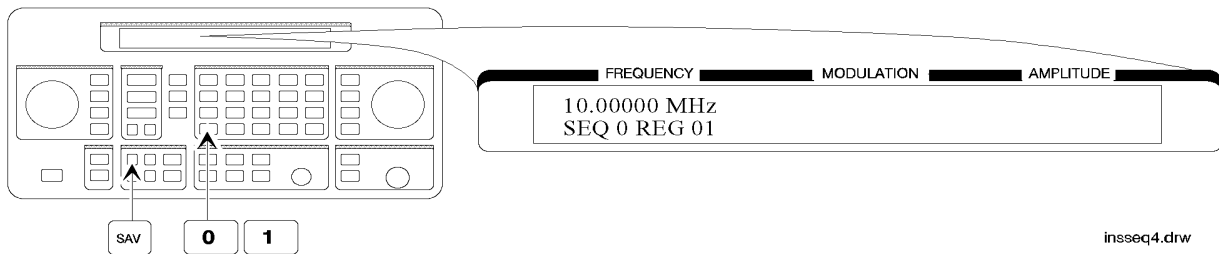

Saving a New Register

5. Set the frequency to 8 MHz.

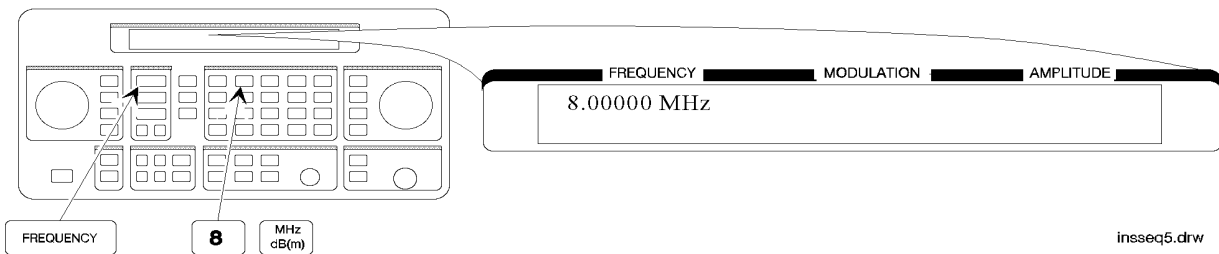

6. Save the settings in register 00.

Press \uparrow to check the new sequence.

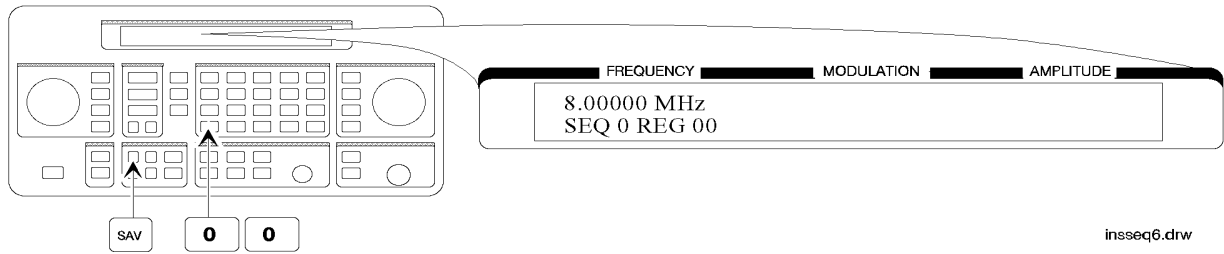

Offsetting the RF Output from a Reference

In this example, you will enter an RF output frequency, set it as the reference value, and then offset the RF output frequency 10 MHz below the reference value.

Setting the Reference Value

1. Set the frequency to 500 MHz.

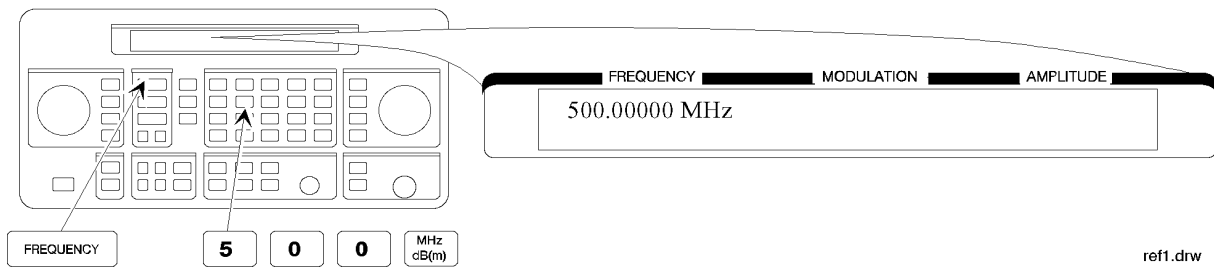

2. Set 500 MHz as the reference frequency.

The Δ symbol appears in the display to indicate that the reference mode is selected. The output frequency is still 500 MHz.

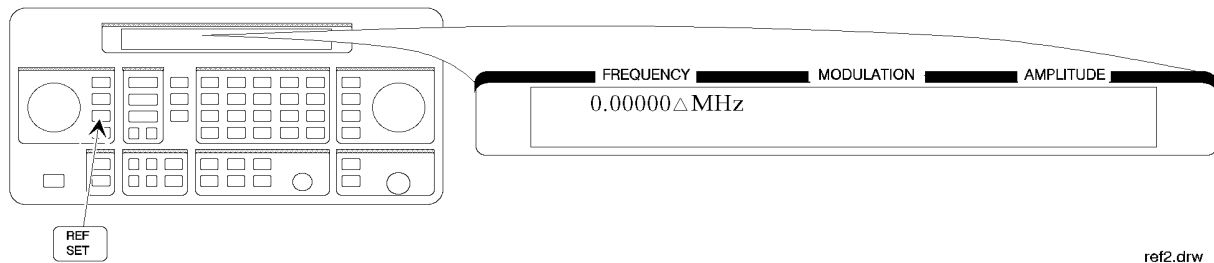

Offsetting the RF Output

3. Offset the output frequency 10 MHz below the reference frequency.

You can enter in the offset value directly, or use the knob or \uparrow and \downarrow keys.

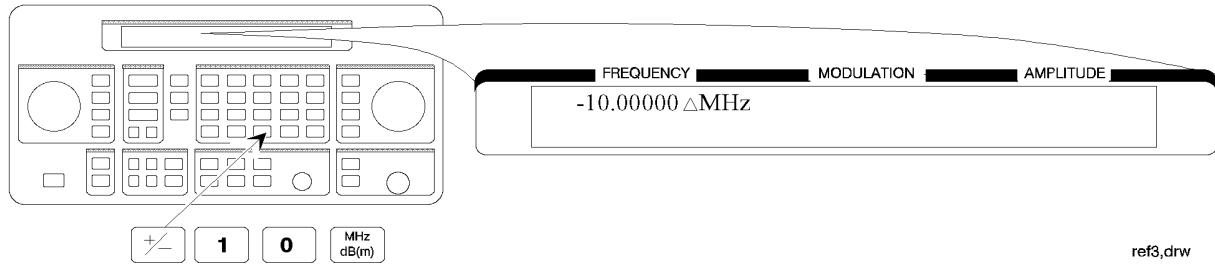

Attention! In the reference mode, the output frequency equals the reference frequency \pm the displayed offset frequency.

Turning the Reference Mode Off or On

4. Turn off the reference mode to display the actual output frequency.

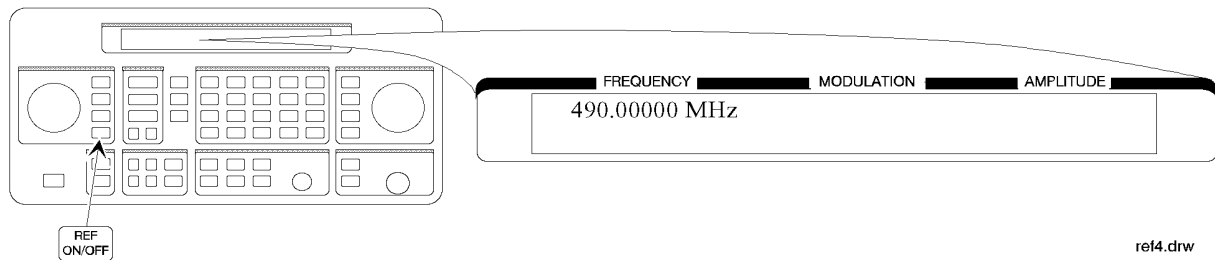

5. Turn on the reference mode without changing the reference frequency.

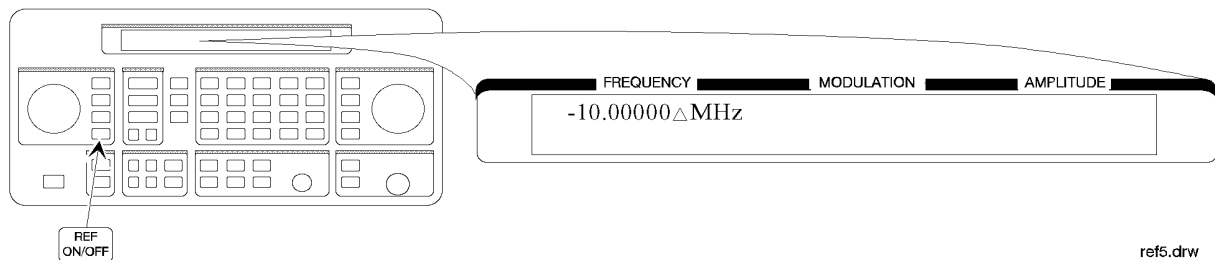

6. Change the displayed units to kHz.

Note that for amplitude, reference settings are displayed in dB units only.

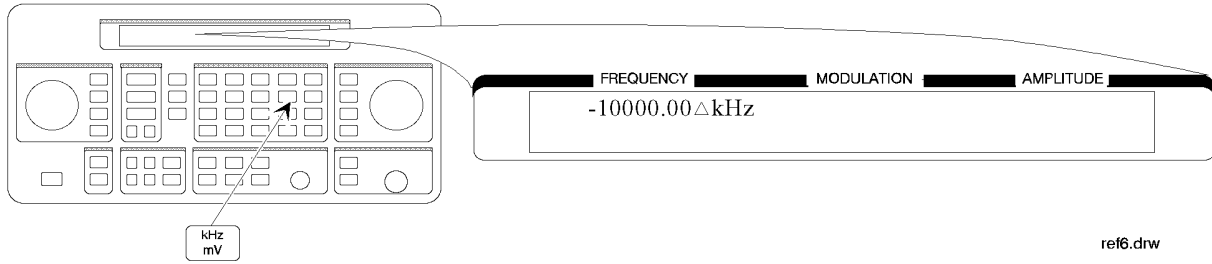

Setting a New Reference Value

7. Set the current output frequency as the new reference frequency at any time.

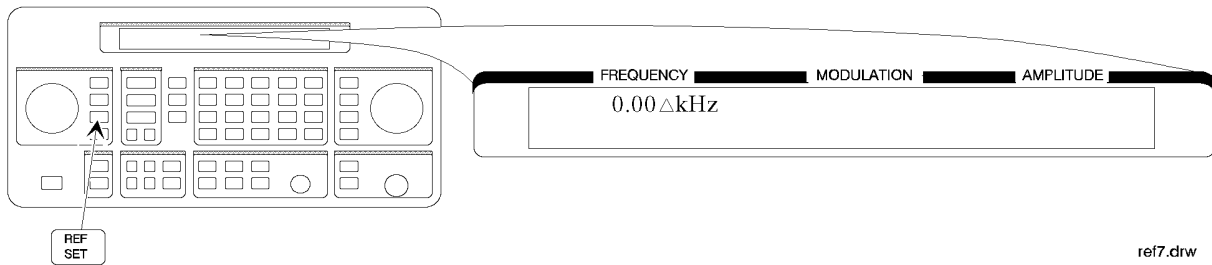

Holding the Output Attenuator Range

In this example, you will hold the output attenuator so it does not change ranges when you change the amplitude setting. This will prevent attenuator range changes from affecting the output signal.

Set the Amplitude Level

1. Set the amplitude level to -82 dBm.

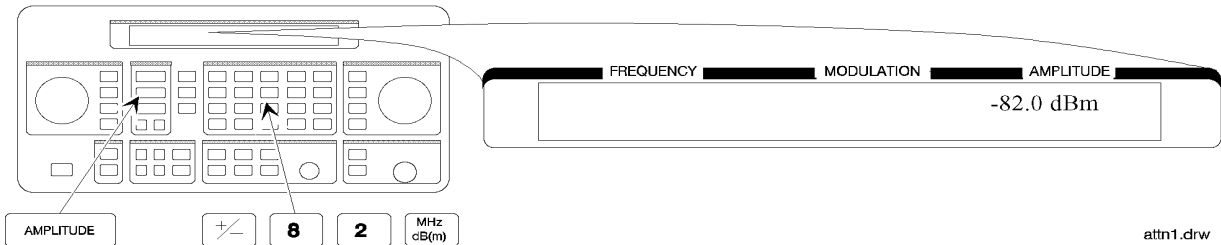

Holding the Attenuator

2. Hold the attenuator at this setting.

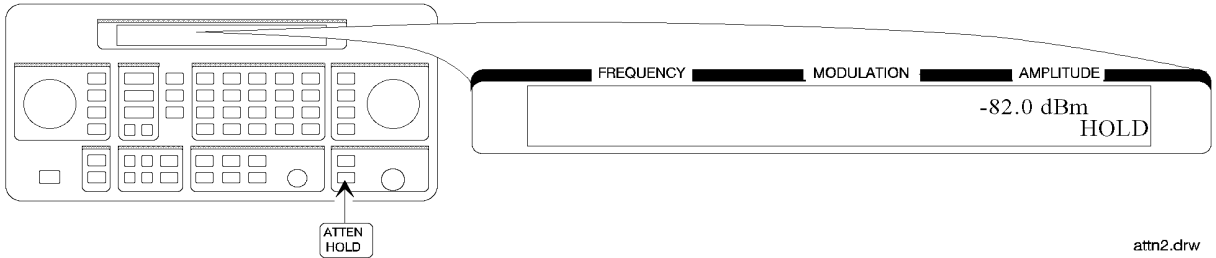

Adjusting the Amplitude

3. Adjust the amplitude setting.

Now amplitude changes do not cause the attenuator to change its range setting. Consequently, amplitude changes are limited to the range provided by the instrument's vernier. For information about the instrument's vernier ranges, refer to Chapter 1b, "Operation Reference."

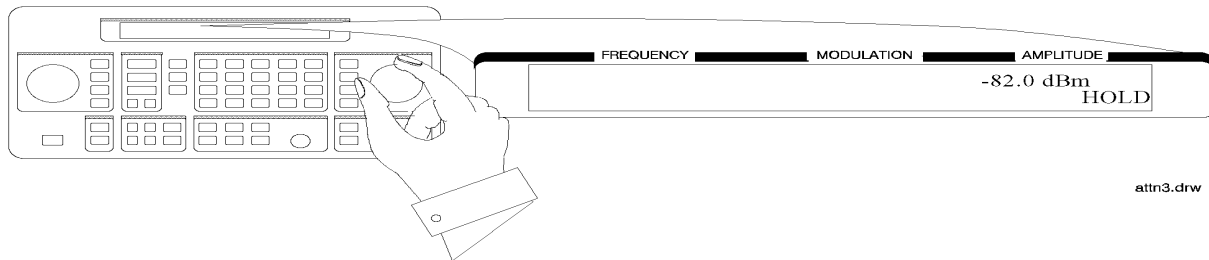

attn3.drw

Setting a User Selectable Modulated Frequency and Waveform (Option 1E2 or 1EP Only)

NOTE This modulation example can only be performed if Option 1E2 or 1EP is present.

In this example, you will select the modulation level and the modulated frequency and waveform of the RF signal output.

Setting the Modulation Level

1. Select FM modulation with a deviation of 25 kHz.

Either **AM** or **ΦM** modulation may be used instead of **FM**. The modulation type (FM, AM, or ΦM) and the modulation level (deviation or depth) is displayed on the top line of the front panel display as shown.

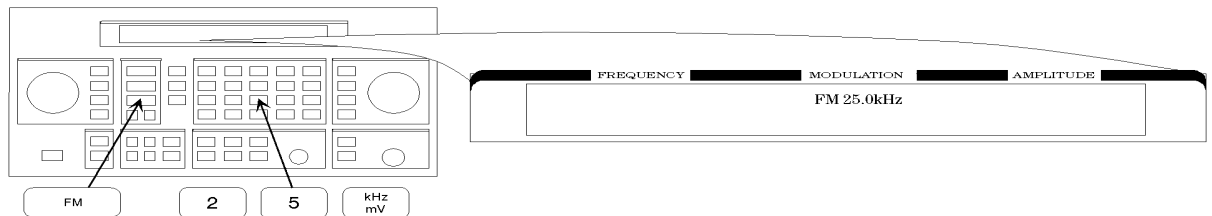

on69bd

Setting the Modulated Waveform

2. Press the **INT 1kHz** (FREQUENCY/WAVEFORM) key until **SQU** is selected.

Repetitively pressing the **INT 1kHz** (FREQUENCY/WAVEFORM) key selects one of five states:

- a fixed 1 kHz sinewave internal source
- a variable-frequency sinewave source (indicated by **SIN** preceded by the frequency value)
- a variable-frequency triangle source (**TRI**)
- a variable-frequency squarewave source (**SQU**)
- a variable-frequency sawtooth (or ramp) source (**SAW**)

Setting a User Selectable Modulated Frequency and Waveform (Option 1E2 or 1EP Only)

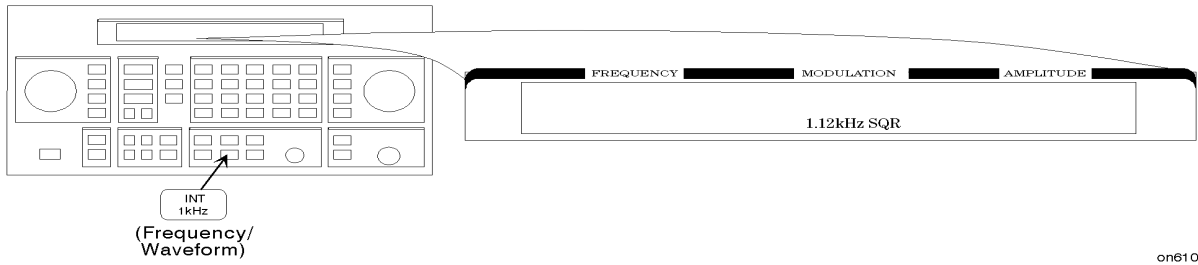

Setting the Modulated Frequency

3. Set the modulated frequency to 1.5 kHz.

The kHz key is the only accepted units key.

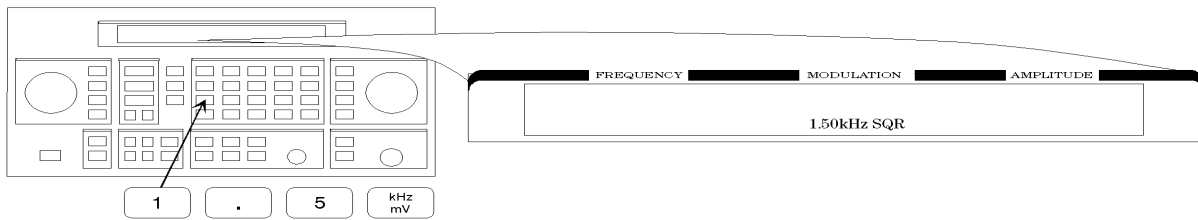

Signaling a Numeric-Type FLEX Pager (Option 1EP Only)

In this example you will set up the pager encoder to send a signal appropriate to test a numeric-type FLEX pager.

NOTE This pager encoding example can only be performed if Option 1EP is present. The front panel of the Option 1EP instrument is different from the standard instrument's front panel. The green and blue labels are incorporated for the pager encoding mode only. Therefore, these keys have multiple functions on instruments with Option 1EP.

Figure 1a-1. The 8648A Option 1EP Signal Generator

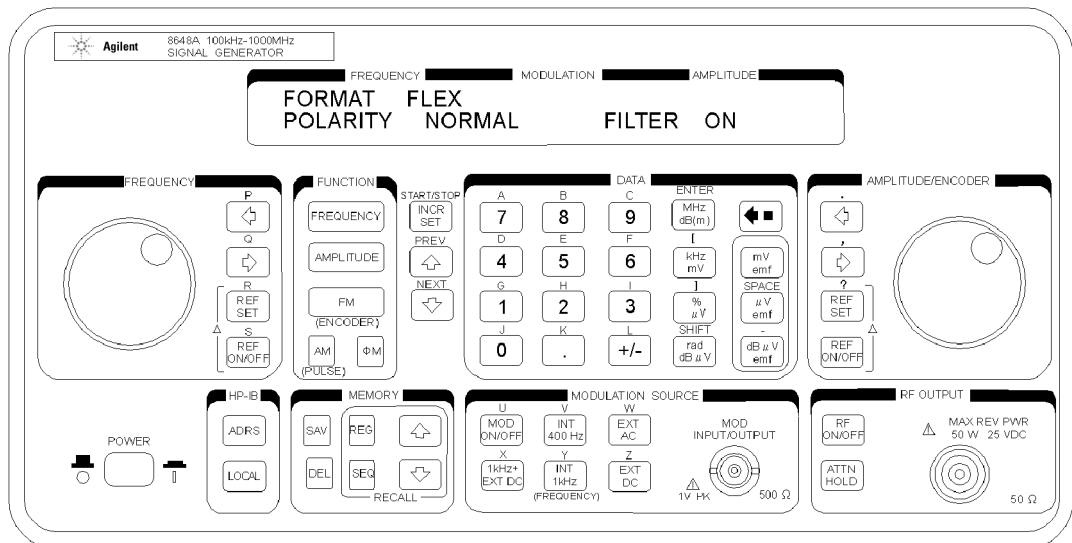

Setting Up Pager Encoding

The following steps are required to set up pager encoding on the signal generator. Details of setting each parameter are provided following this overview.

1. Before entering the signal generator pager encoder mode, set the correct carrier frequency and FM deviation for the pager-under-test. (The FM deviation is 4.8 kHz for FLEX and is 4.5 kHz for POCSAG.)
2. Press RF ON/OFF to turn on the RF output. (RF OFF is displayed below the amplitude setting when the RF output is turned off.)
3. Enter the pager encoder mode by pressing FM (ENCODER). If FM wasn't the last active function, press FM (ENCODER) twice.
4. Set up the pager encoder parameters to meet the test requirements of your specific pager.

Use the ↓ (NEXT) and ↑ (PREV) keys to scroll through the encoder parameters. The cursor will blink around the first letter of the active parameter. The ↓ (NEXT) key moves forward sequentially through each pager encoder parameter and the ↑ (PREV) key moves backward sequentially.

To move between setting for each parameter, rotate the AMPLITUDE/ENCODER knob until the desired setting is displayed. When characters are entered by way of the keypad (such as the capcode), terminate the entry with the MHz dB(m) (ENTER) key.

5. Start signaling the pager after all of the encoder parameters are set by pressing the INCR SET (START/STOP) key.

Entering Pager Encoding Settings

1. Display the first pager encoder menu.

After setting your pager's carrier frequency and an FM deviation of 4.8 kHz (for a FLEX pager) on the signal generator, press the FM (ENCODER) key once again to display the first pager encoder menu (FORMAT). The FM (ENCODER) key toggles between the frequency modulation menu and the pager encoder menu.

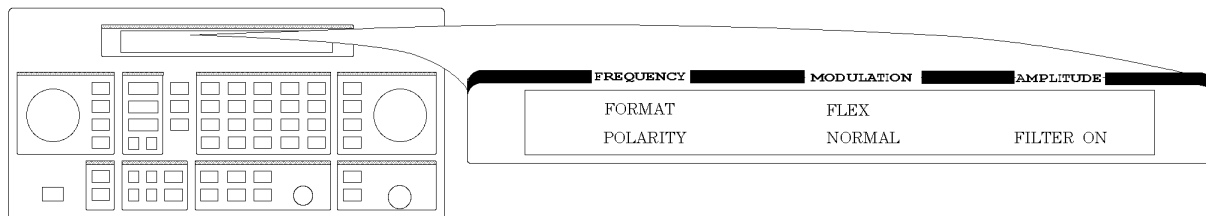

Encode1.drw

Selecting the Format Settings

2. Set FORMAT to FLEX, POLARITY to NORMAL, and FILTER to ON.
 - a. With the blinking cursor on the "F" of FORMAT, set the FLEX format by rotating the AMPLITUDE/ENCODER knob until FLEX is displayed.
 - b. Press the ↓ (NEXT) key to move the blinking cursor to POLARITY, then use the AMPLITUDE/ENCODER knob to set the polarity to NORMAL.
 - c. Using the ↓ (NEXT) key and the AMPLITUDE/ENCODER knob, set FILTER to ON.

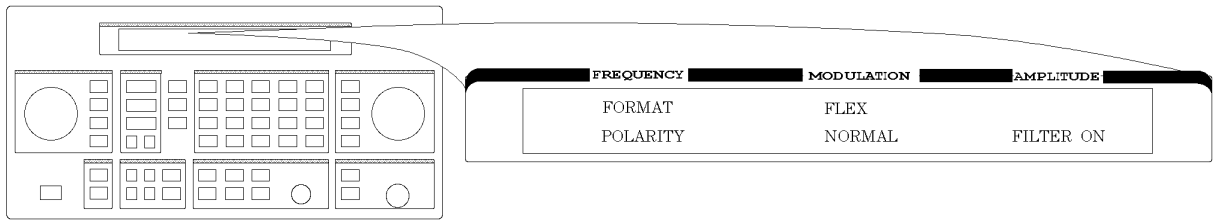

Encode1.drw

Selecting the Data Rate and Pager Type Settings

3. Set DATA RATE to 3200/2 and PAGER TYPE to NUMERIC, using the AMPLITUDE/ENCODER knob and the ↓ (NEXT) key.

You may choose to set the data rate to one of the other settings; you FLEX pager should automatically adjust.

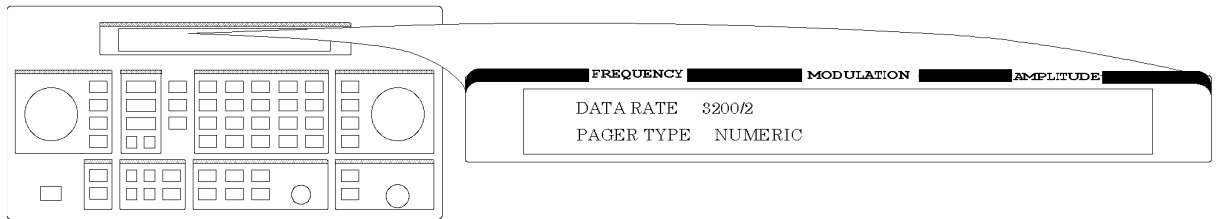

Encode2.drw

Press the ↓ (NEXT) key to move to the next page.

4. Set VECTOR TYPE to STANDARD using the AMPLITUDE/ENCODER knob.

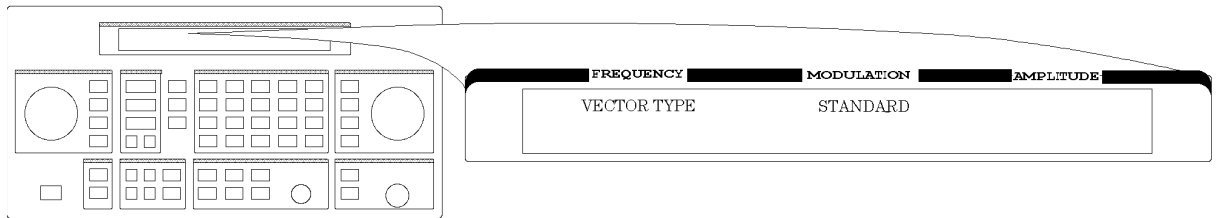

Encode3.drw

Press the ↓ (NEXT) key to move to the next page.

Selecting the Message Settings

5. You may choose one of the five fixed messages (only numbers one and five are useful for numeric pagers) or you may define your own message. For this example, use your own phone number as the user-defined message:
 - a. Set MESSAGE NO. to 6 and MESSAGE LENGTH to 40 using the AMPLITUDE/ENCODER knob and the key.
 - b. Press the ↓ (NEXT) key again to select the FREE MESSAGE parameter.
 - c. Enter your phone number with the numeric keys and terminate your entry with the MHz dB(m) (ENTER) key.

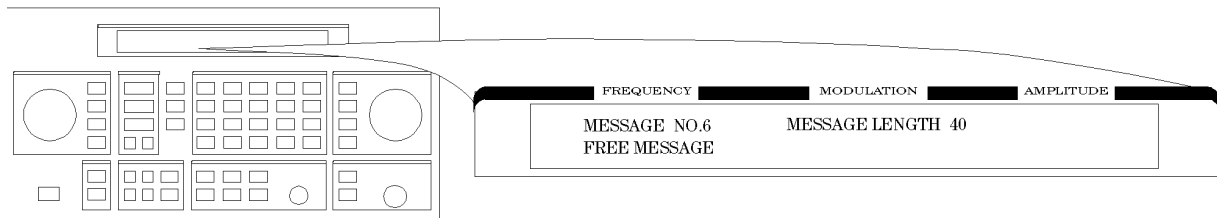

an610abc

Press the ↓ (NEXT) key to move to the next page.

Selecting the Transmission Repetitions and Amplitude

6. Set MODE to SINGLE and AMPLITUDE to 0.0 dBm using the AMPLITUDE/ENCODER knob and the ↓ (NEXT) key. Enter the numeric values using the numeric keys and the MHz dB(m) (ENTER) key.

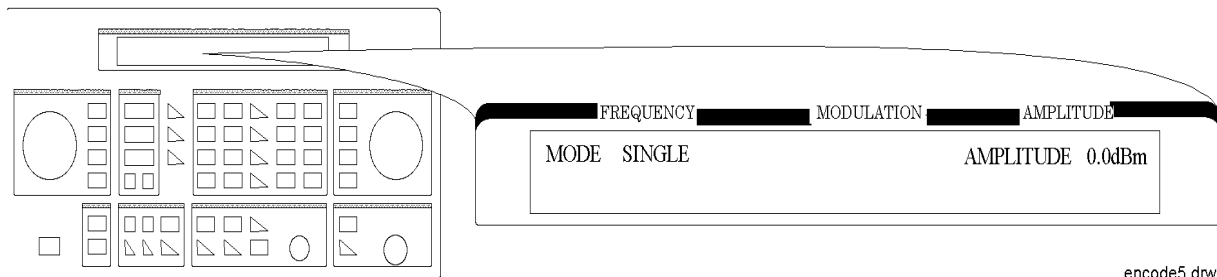

encode5.drw

Press the ↓ (NEXT) key to move to the next page.

7. Set IMMEDIATE STOP to OFF, HEADER to ON, and TERMINATOR to ON using AMPLITUDE/ENCODER knob and the key. These are default settings that normally would not be adjusted.

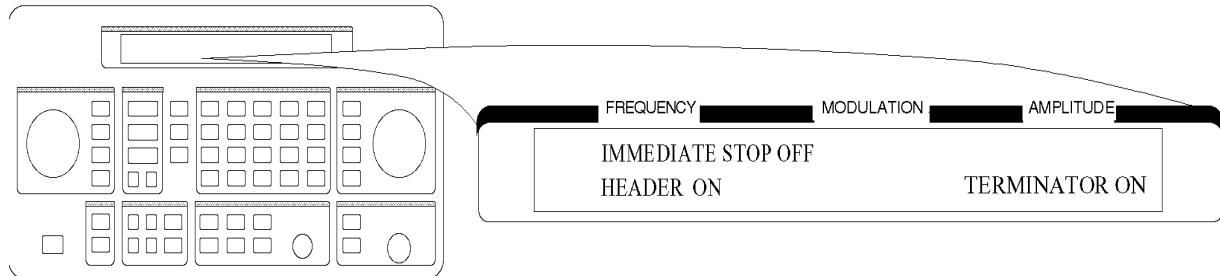

Press the ↓ (NEXT) key to move to the next page.

Selecting the Pager Capcode (Address)

8. Enter your pager's capcode (address) in the pager code menu. The rad dB μ V (SHIFT) key is required to enter alphabetical characters. For example, to enter the following capcode: A0012477, press, 7 (A), 0012477, MHz dB(m) (ENTER). Then, using the ↓ (NEXT) key and the AMPLITUDE/ENCODER knob, set DUMMY CALL to OFF.

NOTE The pager's capcode contains information that automatically sets the parameters of the last two menus.

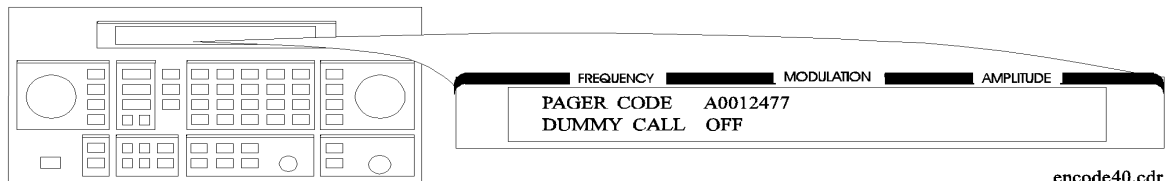

encode40.cdr

Press the ↓ (NEXT) key to move to the next page.

9. ADDRESS TYPE and ADDRESS1 are set automatically when the capcode is entered in the previous menu. If A0012477 was entered, SHORT and 0045245 would be displayed respectively. Generally, you would not change these settings.

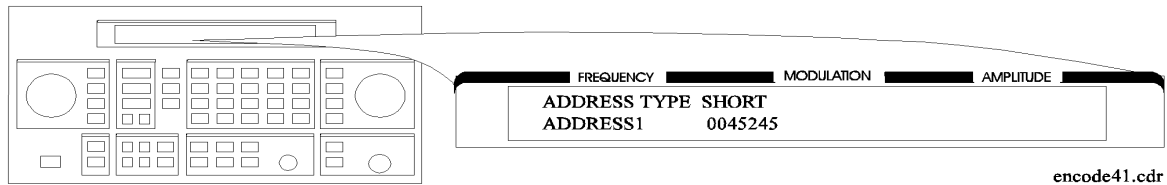

Press the ↓ (NEXT) key to move to the next page.

Selecting the Protocol Settings

10. FRAME, PHASE, and COLLAPSE CYCLE are also set automatically when you enter the pager's capcode. If you entered A0012477 previously, 011, D, and 4 would be displayed.

NOTE If MODE is set to BURST or CONT instead of SINGLE, you may choose to change the collapse cycle to 1 to 7. With a collapse cycle of 4, the pager will receive the message once every 16 frames (2^4). If the collapse is 0 or 1, the pager will receive the message either every frame (2^0), or every other frame (2^1).

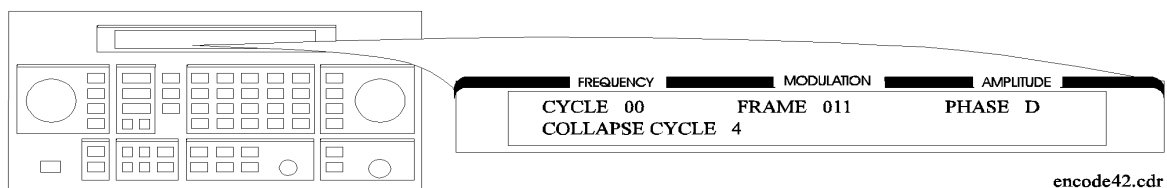

Press the ↓ (NEXT) key to move to the next page.

Selecting the Roaming Mode Settings

11. Set ROAMING MODE to NONE using the AMPLITUDE/ENCODER knob.

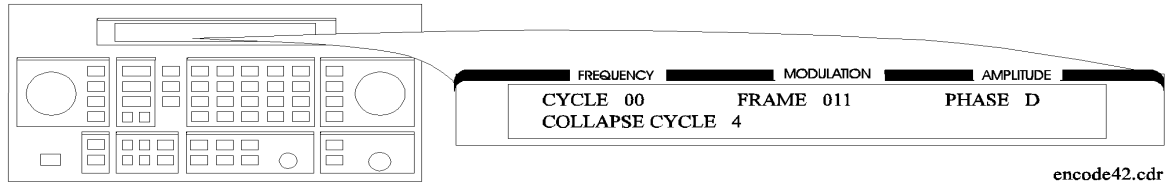

Press the ↓ (NEXT) key to move to the next page.

Encoding

12. To start encoding after selecting all pager encoder parameters, press the INCR SET (START/STOP) key.

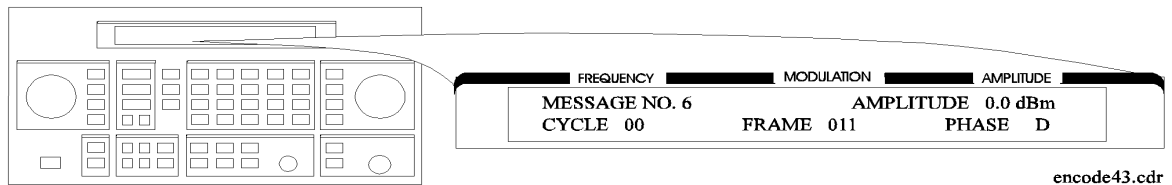

Operation Examples
Signaling a Numeric-Type FLEX Pager (Option 1EP Only)

1b Operation Reference

This chapter describes each of the instrument's functions including all of the front panel keys, the rear panel connectors, and the optional remote interface and memory interface. This information is presented in the same functional groups as the front panel key functional groupings.

NOTE Option 1EP adds a pager encoder capability to the standard functions. Consequently the front panel of the Option 1EP instrument is different from the standard instrument's front panel. The green and blue labels are incorporated for the pager encoding settings only. Therefore these keys have multiple functions on instruments with Option 1EP.

Frequency and Amplitude

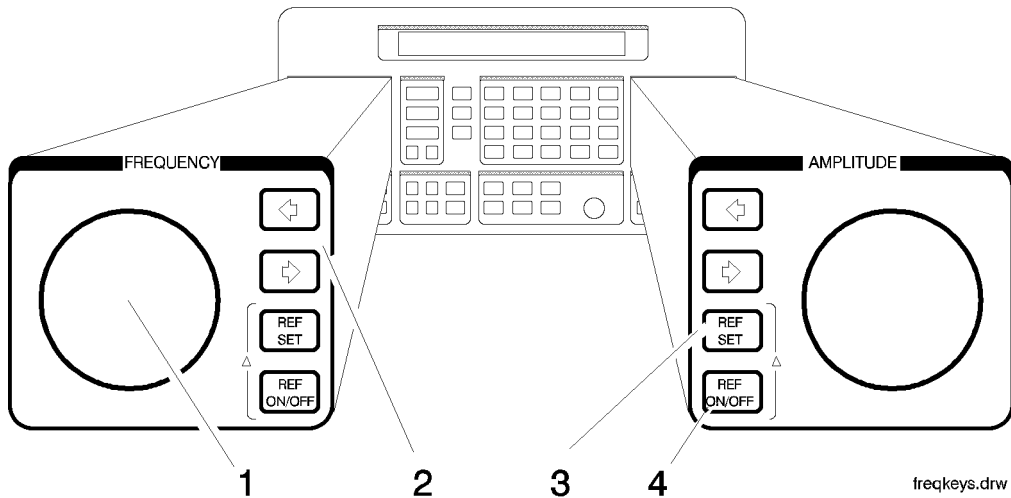

The knob and reference set keys work similarly for both frequency and amplitude settings.

1. Knob

Turn the knobs to increment or decrement the frequency and amplitude settings. The knobs are always active when the instrument is in local operation.

If Option 1EP is present and the signal generator is in the ENCODER mode, the knob in the AMPLITUDE/ENCODER block is used to select the desired setting for each pager encoder parameter.

2. Digit-Select Arrow Keys

Press these digit-select arrow keys ($\leftarrow \rightarrow$) to select the digit to be changed with the knob.

NOTE The knobs increment the selected digit only. For information about incrementing by an arbitrary value using the increment set keys, see “Increment Set” in this chapter.

3. REF SET

Press REF SET to turn on the reference mode and to set the current RF output setting as the reference value. The reference value is stored in non-volatile memory until you replace it by pressing REF SET again.

When you press **REF SET**, the Δ symbol is displayed between the value and the units. When Δ appears, the displayed value indicates the offset between the reference value and the RF output signal.

The RF output signal is not changed when you press this key.

Units

When you press **REF SET** for frequency, values can be entered in MHz or kHz. For amplitude, values can be entered in any of the amplitude units provided, but they are displayed in dB only.

4. REF ON/OFF

Press **REF ON/OFF** to turn off the reference mode if it is on, or to turn on the reference mode without changing the reference value.

When you turn on the reference mode, the displayed value indicates the offset between the reference value and the current RF output setting.

The RF output signal is not changed when you press this key.

Output Power Trouble?

If the RF output power seems too low, look for Δ in the display between the power level value and the dB indicator. The Δ tells you that reference mode is turned on. The displayed value is not the output power level; it is the offset between the reference value and the output power. To exit the reference mode, press **REF ON/OFF**. You can then reset the output power to the desired level.

Function

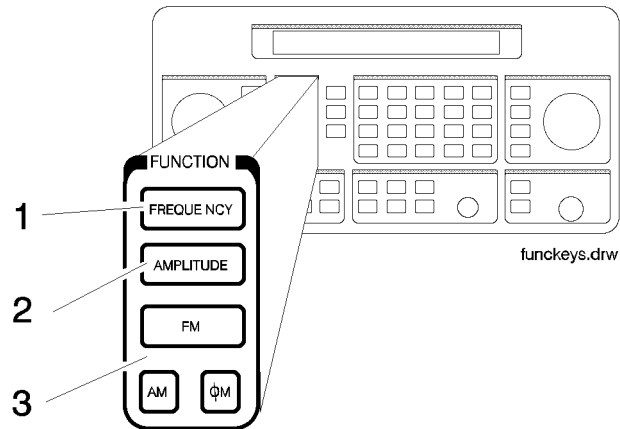

1. FREQUENCY

The RF output frequency range for each model is shown in the following table. When making frequency changes, the instrument does not turn off the RF output. However, the power does blank for a few milliseconds when crossing the frequencies at 249, 501, 1001, 1260, 1600, 2001, 2520, and 3200 MHz.

Model	Frequency Range
8648A	100 kHz to 1000 MHz
8648B	9 kHz to 2000 MHz
8648C	9 kHz to 3200 MHz
8648D	9 kHz to 4000 MHz

Frequency switching typically takes less than 75 ms at frequencies lower than 1001 MHz, and less than 100 ms at higher frequencies.

2. AMPLITUDE

The RF output amplitude range is shown in the following table. When making amplitude changes, the instrument does not turn off the RF output. The period of any over- or under-ranging that may occur during level transitions is typically less than 30 ms.

Output Amplitude Ranges		
Model	Frequency Range	Amplitude
8648A	100 kHz to 1000 MHz	+10 to -136 dBm
8648B/C/D	≥ 2500 MHz	+13 to -136 dBm
	> 2500 MHz	+10 to -136 dBm
8648B/C/D with Option 1EA	< 100 kHz	+17 to -136 dBm
	≤ 1000 MHz	+20 to -136 dBm
	≤ 1500 MHz	+19 to -136 dBm
	≤ 2100 MHz	+17 to -136 dBm
	≤ 2500 MHz	+15 to -136 dBm
	> 2500 MHz	+13 to -136 dBm

3. FM, AM, Φ M

Press **FM** to set the peak deviation for frequency modulation. Then use the data entry keys to enter the desired value of deviation. The values allowed depend on the RF frequency selected. See Chapter 4, "Specifications" for peak deviation specifications.

Press **AM** to set the amplitude modulation range. Then use the data entry keys to set the desired value of range. Values from 0 through 100% are allowed.

Press **Φ M** to set the peak deviation for phase modulation. Then use the data entry keys to enter the desired value of deviation. The values allowed depend on the RF frequency selected. See Chapter 4, "Specifications" for peak deviation specifications.

Setting Up the Pager Encoder

NOTE The pager encoder mode is available only on instruments with Option 1EP. Option 1EP adds pager encoding/signaling capabilities to the standard functions. Consequently the front panel of the Option 1EP instrument is different from the standard instrument's front panel. The green and blue labels are incorporated for the pager encoding settings only. Therefore, these keys have multiple functions on instruments with Option 1EP.

Figure 1b-1. 8648A Option 1EP Signal Generator

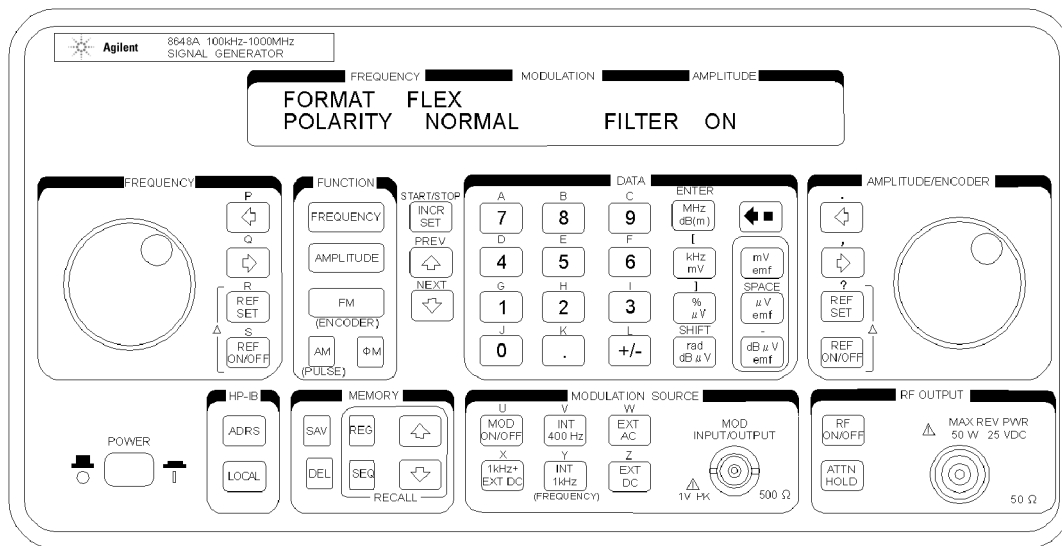

For numeric messages, the following keys are assigned for the special characters in addition to the standard numeric keys (0 to 9).

Front Panel Key	Character	B3	B2	B1	B0
S	Spare	1	0	1	0
U	U	1	0	1	1
Space	Space	1	1	0	0
-	- (Hyphen)	1	1	0	1
]]	1	1	1	0
[[1	1	1	1

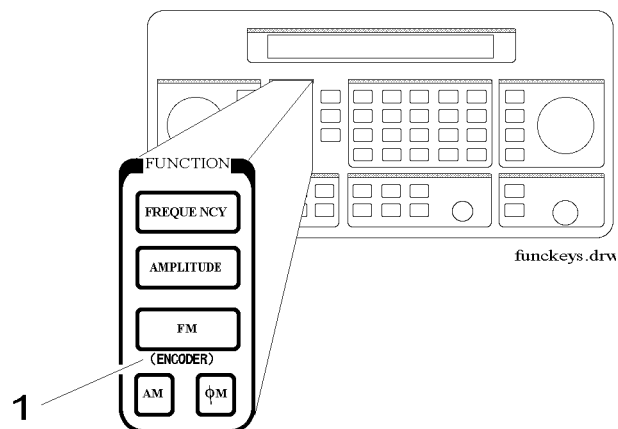

1. ENCODER

NOTE Before selecting the pager encoder mode, check that the correct pager carrier frequency and FM deviation have been set.

To select the pager encoder mode, press **FM (ENCODER)** twice: once to set FM deviation, then again to toggle between the standard functions and the pager encoder mode. The display will look like the following:

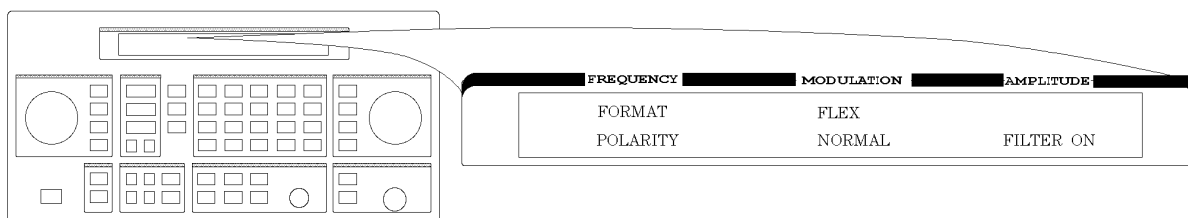

This format menu is always displayed first when the pager encoder mode is selected.

The \uparrow (PREV) and \downarrow (NEXT) keys are used to move the blinking cursor between each parameter.

The knob in the AMPLITUDE/ENCODER block is used to select the desired setting for each pager encoder parameter.

To start or stop encoding, press **INCR SET (START/STOP)**.

Setting the Format

The format menu, shown in the previous figure, has the following settings:

- **FORMAT** selects the pager protocol being tested.

FLEX: FLEX format
 FLEX-TD: FLEX-TD format
 POCSAG: POCSAG format
 PN15: Pseudorandom Sequence (PN15)
 RESYNC: Re-synchronization function (for FLEX/FLEX-TD pagers only)
 SERVICE: Servicing the 8648A Option 1EP

- **POLARITY** selects the data polarity.

Normal: Normal polarity

POCSAG	FLEX/FLEX-TD (2-Level FSK), RESYNC, PN15	FLEX/FLEX-TD (4-Level FSK)
"1": Carrier – Deviation	"1": Carrier + Deviation	"10": Carrier + Deviation "11": Carrier + (Deviation/3) "01": Carrier – (Deviation/3)
"0": Carrier + Deviation	"0": Carrier – Deviation	"00": Carrier – Deviation

INVERSE: Inverse polarity

POCSAG	FLEX/FLEX-TD (2-Level FSK), RESYNC, PN15	FLEX/FLEX-TD (4-Level FSK)
"1": Carrier + Deviation	"1": Carrier – Deviation	"10": Carrier – Deviation "11": Carrier – (Deviation/3) "01": Carrier + (Deviation/3)
"0": Carrier – Deviation	"0": Carrier + Deviation	"00": Carrier + Deviation

- **FILTER** selects whether or not the baseband modulation filter (10th-order Bessel low-pass filter, –3 dB at 3.9 kHz) is used. Normally the filter is on.

ON: Uses the low-Pass filter
 OFF: Does not use the low-pass filter

FLEX/FLEX-TD

Setting the data Rate and Pager Type

The parameter menu for the data rate and the pager type looks like the following:

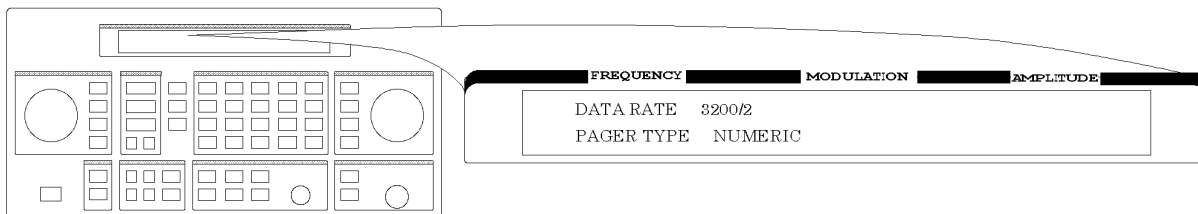

Encode2.drw

- **DATA RATE** specifies how fast the data stream is output in bits per second and whether it is 2-level or 4-level FSK.

1600/2: 1600 bps, 2-level FSK

3200/2: 3200 bps, 2-level FSK

3200/4: 3200 bps, 4-level FSK

6400/4: 6400 bps, 4-level FSK

- **PAGER TYPE** specifies the type of message a pager under test can respond to and is selectable from the following:

TONE ONLY: Short Message/Tone only type

NUMERIC: Numeric type

ALPHANUMERIC: Alphanumeric type

HEX/BIN: HEX/Binary type

If NUMERIC is selected, the next setting to be selected is VECTOR TYPE as shown:

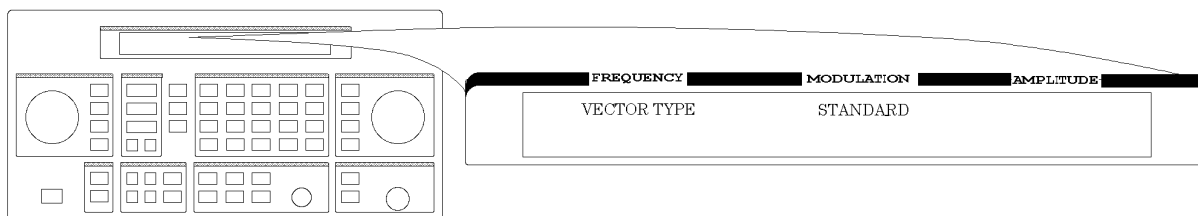

Encode3.drw

- **VECTOR TYPE** identifies the type of message as follows:

STANDARD: The pager-under-test displays the numeric message it receives.

SPECIAL: The pager-under-test converts the numeric message to a pre-defined message which is displayed.

NUMBERED: The message numbers are assigned for each paging address separately starting at 0 and progressing up to a maximum of 63 in consecutive order.

If NUMBERED is selected, the next parameter to be selected is NUMBER as follows.

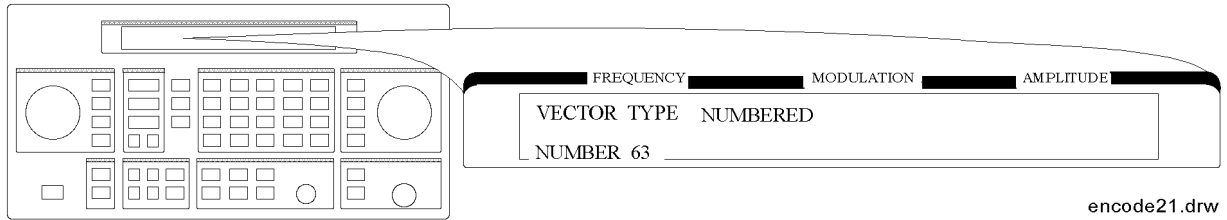

NUMBER is for setting the initial number of the numbered numeric message that will be transmitted. The allowable range is 0 to 63.

If HEX/BIN is selected, the next setting to be selected is BLOCKING LENGTH:

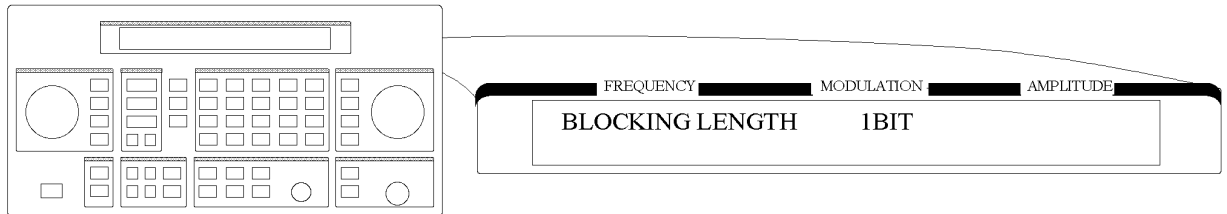

- BLOCKING LENGTH indicates the bits per character as follows:

1BIT:	1 bit per character
7BITS:	7 bits per character
8BITS:	8 bits per character
14BITS:	14 bits per character
16BITS:	16 bits per character

Enter the message in the hexadecimal format to the MESSAGE NO. 6 in the message menu.

NOTE When 7BITS or 14BITS are selected, the total number of hexadecimal characters of the message must be a multiple of 7 characters (28 bits).

Setting the Message The message menu looks like the following:

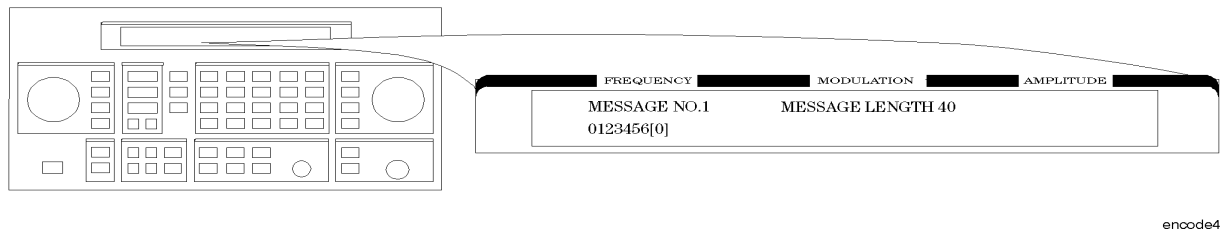

Setting the Encoding Mode The number of times a message is transmitted and the level of that transmission are determined by the following menu:

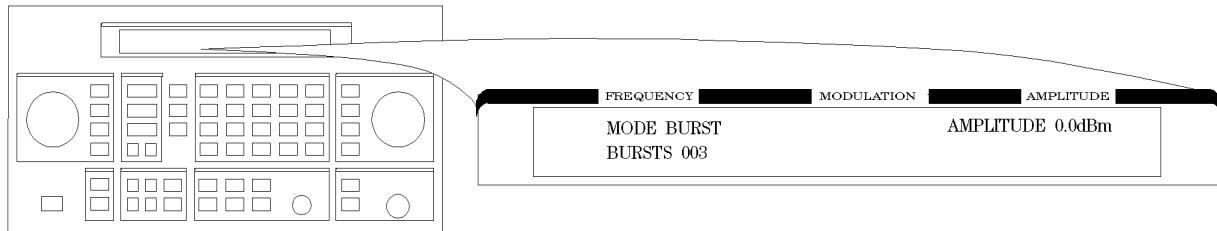

an610abc

- **MODE** determines whether the message will be output once or multiple times when **INCR SET (START/STOP)** is pressed.
 - SINGLE:** Outputs the message once.
 - BURST:** Outputs the message the number of times specified in the **BURSTS** field (3 times in this example).
 - CONT:** Outputs the message continuously until the **INCR SET (START/STOP)** key is pressed a second time. (Note: The collapse cycle described later on in this section will determine how often the message will be transmitted per cycle.)
- **AMPLITUDE** sets the output signal level of the carrier.
- **BURSTS** sets the number of times the message will be transmitted. This parameter is displayed only when the **MODE** parameter is set to **BURST**. The allowable range is 1 to 256.
- **RF OFF** is displayed below the amplitude setting when the RF output is turned off. To toggle the RF signal output on and off, press **RF ON/OFF**.
- **HOLD** is displayed when the step attenuator is held at its current range setting. To toggle the attenuator hold function on and off, press **ATTN HOLD**.

Another menu is displayed as follows for completing the Encoding Mode:

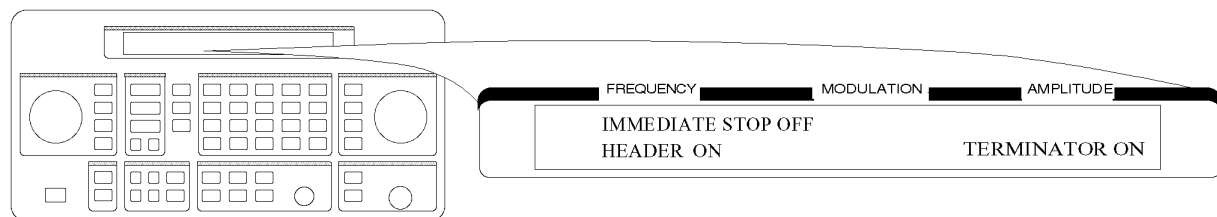

- **IMMEDIATE STOP** terminates pager signaling as follows when a stop event occurs.
 - ON:** Terminates pager signaling immediately.
 - OFF:** Default setting. Terminates pager signaling just before the next instance the pager is on. (If **TERMINATOR** is set to **ON**, the pager encoder generates the re-synchronization pattern in the frame that was supposed to contain the message.)
- **HEADER** sets whether the idle frame signal is output in the frame before the first message.
 - ON:** Default setting. Outputs the idle frame signal.
 - OFF:** Does not output the idle frame signal.

- **TERMINATOR** sets whether the re-synchronization pattern is output after the last message. The collapse cycle will determine in which frame the re-synchronization pattern appears after the **INCR SET (START/STOP)** key is pressed to stop or at the end of a burst sequence (refer to “FLEX/FLEX-TD Signaling Examples”).

ON: Default setting. Outputs the re-synchronization pattern.

OFF: Does not output the re-synchronization pattern.

NOTE If **TERMINATOR** is set to **OFF**, the pager under test is not synchronized. Therefore, the pager can not be synchronized with the future page until the re-synchronization pattern is sent. To send the re-synchronization pattern, set **TERMINATOR** to **ON** in this menu or select **RESYNC** in the format menu.

Entering the Pager Capcode (Address) The pager code menu looks like the following:

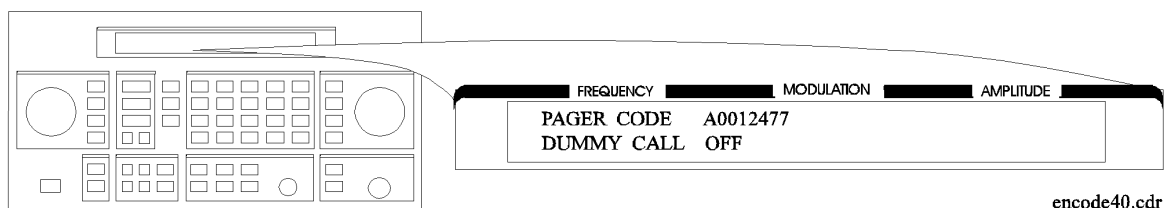

- **PAGER CODE** accepts alphanumeric characters up to 16 digits.

Use the numeric keys to enter the capcode. To select an alphabetical character, press **rad/dBμV (SHIFT)** before the numeric key associated with the desired alphabetic character. Terminate your entry with the **MHz/dB(m) (ENTER)** key.

A **FLEX/FLEX-TD** pager’s capcode contains address and protocol information. Entering the capcode in the **PAGER CODE** data field automatically sets up the **ADDRESS TYPE**, **ADDRESS1**, and **ADDRESS2** in the address menu, and the **FRAME**, **PHASE**, and **COLLAPSE CYCLE** in the protocol menu as well.

The following table shows an example of the conversion from capcodes to the parameters. Note that the values of **COLLAPSE CYCLE** and **FRAME** are changed.

Capcode	ADDRESS TYPE	ADDRESS1	ADDRESS2	FRAME	PHASE	COLLAPSE CYCLE
A0012477	SHORT	0045245	None	011	D	4
2A0012477	SHORT	0045245	None	011	D	2
1272A0012477	SHORT	0045245	None	127	D	2

Function

- **DUMMY CALL** inserts a message with all 5s in all non-call phases. This is required by the **FLEX-TD** standard (RCR STD-34A) for sensitivity testing.

ON: Default setting. Activates the dummy call function for equalizing the FSK deviation. An address for the non-call phases must be set.

OFF: Does not activate the dummy call function. Idle frames are set in the non-call phases.

The address menu will display the following information:

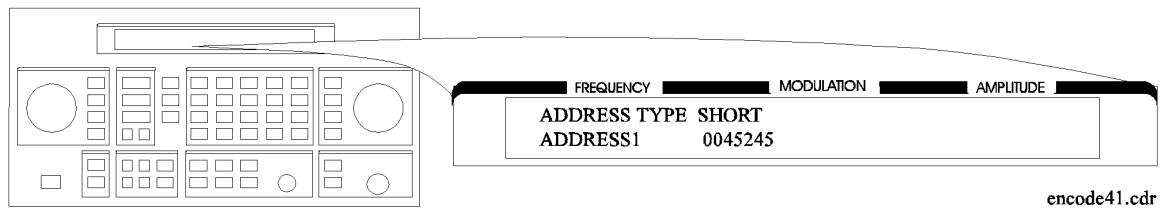

- **ADDRESS TYPE** selects the address length.
 - SHORT:** Short address
 - LONG:** Long address
- **ADDRESS1** is the 7-digit short address or the primary address of the long address.
- **ADDRESS2** is the 7-digit secondary address of the long address. (This is displayed only when **ADDRESS TYPE** is set to **LONG**.)

If **DUMMY CALL** is ON, the following address menu is displayed.

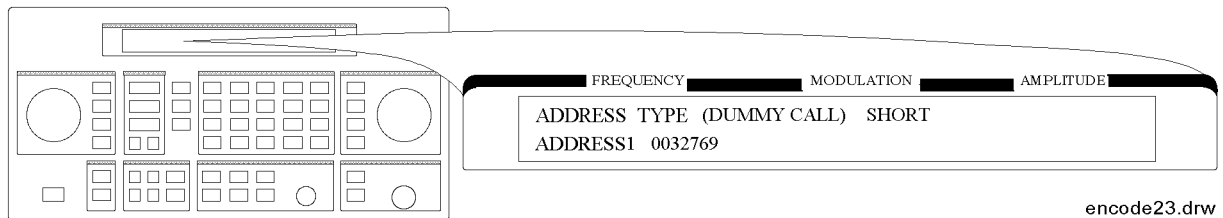

- **ADDRESS TYPE (DUMMY CALL)** displays the address type used in the non-call phases (automatically set).
 - SHORT:** Short address
 - LONG:** Long address
- **ADDRESS1** is the 7-digit short address or the primary address of the long address.
- **ADDRESS2** is the 7-digit secondary address of the long address. (This is displayed only when **ADDRESS TYPE (DUMMY CALL)** is **LONG**.)

NOTE To equalize the FSK deviation, the addresses for **DUMMY CALL** should contain an equal number of “1” and “0”.

Setting the Protocol The protocol menu displays the following information when “A0000001” is the previously entered capcode.

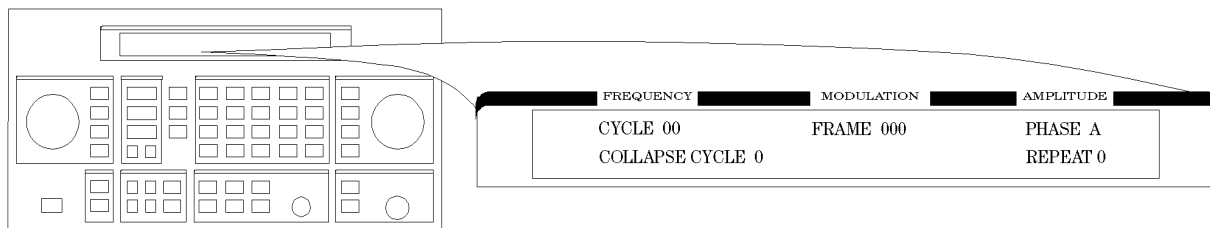

an613abc

These parameters, except for **CYCLE**, are all automatically set when the capcode is entered in the **PAGER CODE** data field.

- **CYCLE**: Defines the start cycle. The allowable range is 0 to 14.
- **FRAME**: Defines the start frame where the message is located. The allowable range is 0 to 127.
- **PHASE**: Defines the phase for the pager. The allowable range is A, B, C, or D.
- **COLLAPSE CYCLE**: Determines how many times a message repeats within a cycle when **BURST** or **CONT** is active in the **ENCODING MODE** setting. The default setting of 4 will repeat the message once every 16 frames (2^4). The allowable range is 0 through 7.
- **REPEAT**: displayed only if **FLEX-TD** is selected in the **FORMAT** menu. Defines the repetition transmission value. Determines how many cycles the message will be repeated. The allowable range is 0 to 3.

Setting the Roaming Mode

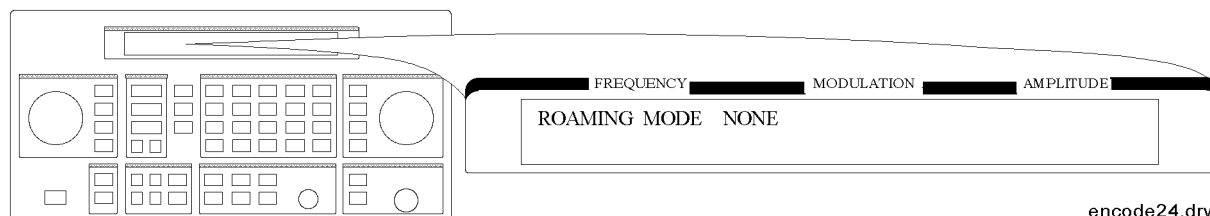

encode24.drw

- **ROAMING MODE** determines the mode in which a pager is used.
 - NONE**: Tests a pager without the roaming mode.
 - SSID**: Tests a pager in the SSID mode which responds to a simulcast transmission system. SSID consists of three words as follows:
 - **SSID1 (BIW000)**:
 - Local Channel ID
 - Coverage Zone
 - **SSID2 (BIW111)**:
 - Country Code
 - Traffic Management Flag
 - **Frame Offset (BIW101)**

SSID, NID: Tests a pager in the SSID and NID modes. The NID mode, in addition to the SSID mode, is a roaming network for covering wider multiple areas. NID consists of a network address and a short message vector as follows:

- SSID1 (BIW000):
Local (Channel) ID
Coverage Zone
- SSID2 (BIW111):
Country Code
SSID Traffic Management Flag (TMF)
- Frame Offset (BIW101)
- NID
Network Address: 21 bits
Short Message Vector:
RF Channel (M)
Multiplier
(Service) Area
NID Traffic Management Flat (TMF)

NOTE When ALPHANUMERIC is selected in the `PAGER TYPE` field and `SSID, NID` is selected in the `ROAMING MODE` field, the maximum allowable range of the `MESSAGE LENGTH` field is limited to 35.

The following menu is displayed for setting the SSID mode for a pager to be tested:

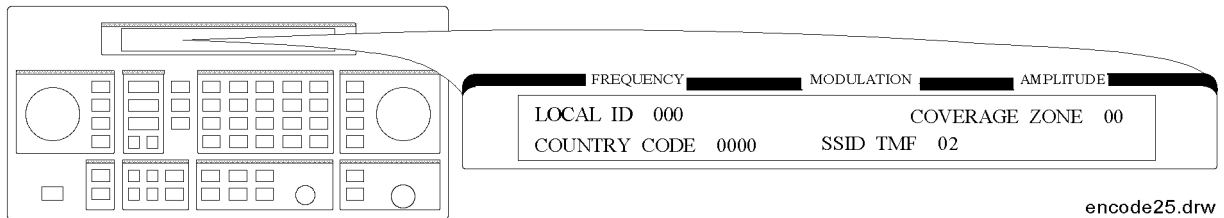

- `LOCAL ID`: Defines the local channel ID of a pager under test. The allowable range is 0 to 511.
- `COVERAGE ZONE`: Defines the coverage zone of a pager under test. The allowable range is 0 to 31.
- `COUNTRY CODE`: Defines the country code. The allowable range is 0 to 1023.
- `SSID TMF`: Defines the SSID traffic management flag. This value is automatically set when the capcode 9address) is entered in the `PAGER CODE` data field. The allowable range is 0 to 15.

After completing the previous menu, set **FRAME OFFSET** in the following menu:

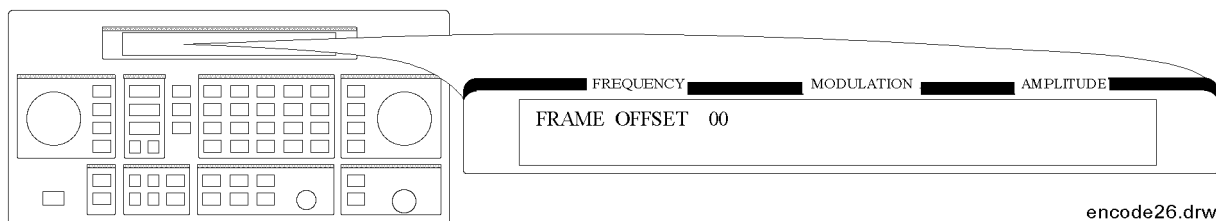

- **FRAME OFFSET:** Defines the number of frames to be offset by BIW101 from the signaling frame at the home area. The allowable range is 0 to 63.

The next menu is displayed for setting the NID mode after completing the SSID mode settings only if the SSID and NID modes are selected.

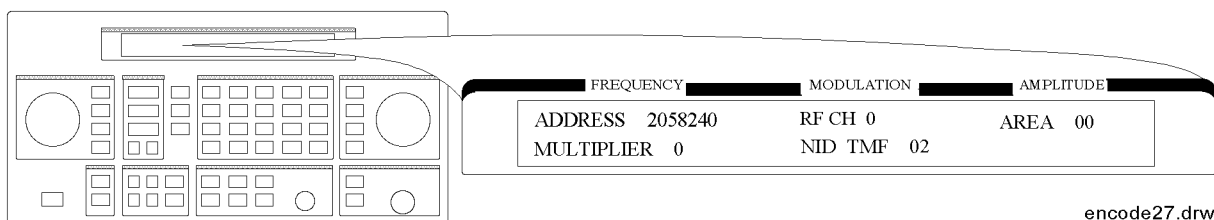

- **ADDRESS:** Defines the network address which appears on the RF channel within the address field in predicted frames. The allowable range is 2058240 to 2062335.
- **RF CH:** Represents each RF channel obtained by the formula as follows:

$$\text{RF CH} = \text{Modulo } 8 \text{ of Integer } [(\text{RF Freq. kHz}) / (\text{channel space kHz})]$$
 The allowable range is 0 to 7.
- **AREA:** Defines the service area identification. The allowable range is 0 to 31.
- **MULTIPLIER:** Defines how much the network address is extended. The allowable range is 0 to 7.
- **NID TMF:** Defines NID traffic management flag. This value is automatically set when the capcode (address) is entered in the **PAGER CODE** data field. The allowable range is 0 to 15.

Message During Encoding To start and stop encoding after selecting all pager encoder parameters, press the **INCR SET** (START/STOP) key. The following display is shown during encoding a pager under test:

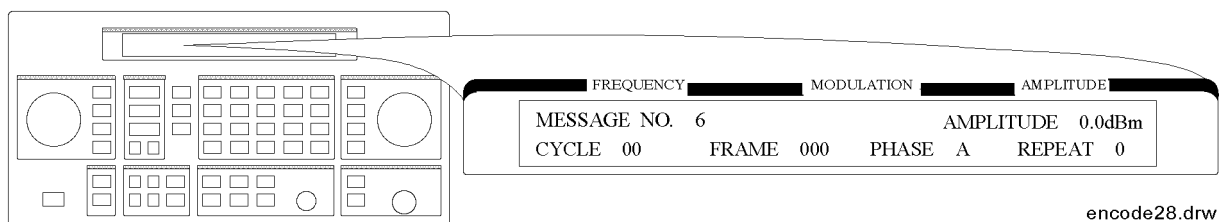

NOTE REPEAT is displayed additionally only if FLEX-TD is selected in the format menu.

If MESSAGE NO. is set to 0, the display is changed as follows:

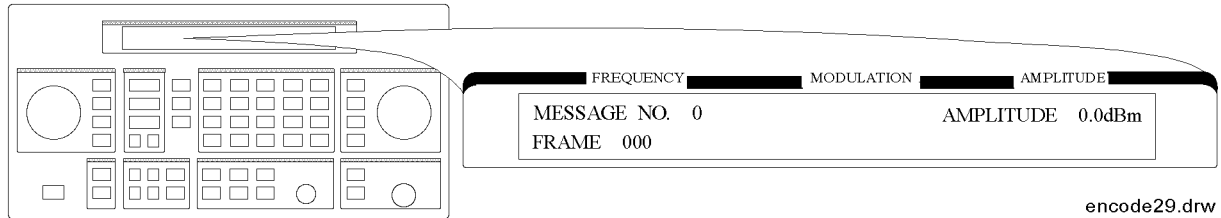

NOTE If the RF output is turned off, AMPLITUDE x.xdBm will be substituted for RF OFF. While encoding, the blinking cursor is on the first character A of AMPLITUDE or R of RF OFF.

Signaling Examples The following examples illustrate the frame structure for the three transmission repetition settings. The HEADER and TERMINATOR parameters are set to ON (default), and the COLLAPSE CYCLE (CC) is set to 1 and 2 (messages will be repeated every 2 frames (2^1) and 4 frames (2^2) respectively).

- SINGLE Mode Example

Start Cycle: 10

Start Frame: 127

Collapse Cycle: Has no effect

- Since HEADER is set to ON, the idle signal is output at Frame 126.
- With TERMINATOR set to ON, the asynchronous state signal is output after the message.

Cycle	10	10	11
Frame	126	127	0
CC = 1	idle	message	asynchronous
CC = 2	idle	message	asynchronous

- BURST Mode Example

Start Cycle: 10

Start Frame: 127

Collapse Cycle: 1 (2^1) and 2 (2^2)

Burst: 3

- Since HEADER is set to ON, the idle signal is output at Frame 126.

- With TERMINATOR set to ON, the asynchronous state signal is output in the frame where the next message was supposed to occur (as determined by the collapse cycle).

Cycle	10	10	11	11	11	11	11	11	11	11	...	11
Frame	126	127	0	1	2	3	4	5	6	7	...	11
CC = 1	idle	message	idle	message	idle	message	idle	asyn- chronous				
CC = 2	idle	message	idle	idle	idle	message	idle	idle	idle	message	...	asyn- chronous

- CONT Mode Example

Start Cycle: 10

Start Frame: 127

Collapse Cycle: 1 (2^1) and 2 (2^2)

Stop: Selected in frame f+ 1

- Since HEADER is set to ON, the idle signal is output at Frame 126.
- With TERMINATOR set to ON, and IMMEDIATE STOP set to OFF, selecting stop will replace the next message with the asynchronous signal.

Cycle	10	10	11	11	11	...	c	c	c	c	c
Frame	126	127	0	1	2	...	f	f + 1	f + 2	f + 3	f + 4
CC = 1	idle	message	idle	message	idle	...	message	idle	asyn- chronous		
CC = 2	idle	message	idle	idle	idle	...	message	idle	idle	idle	asyn- chronous

SSID/NID Roaming Example When the roaming function with SSID and NID is set to on with the following conditions, the contents in each phase are shown in the following table:

- 6400 bps, 4-level FSK
- Call in Phase: A
- Address Type: Long Address

- Roaming Mode: SSID, NID

	Field	Phase A	Phase B, C	Phase D
Word 0 of block 0	BI	Block Info	Dummy Block Info	Dummy Block Info
Word 1 of block 0	BI	BIW000	BIW101 ^a	BIW101 ^a
Word 2 of block 0	BI	BIW111	BIW101 ^a	BIW101 ^a
Word 3 of block 0	BI	BIW101 ^a	BIW101 ^a	BIW101
Word 4 of block 0	AF	Network Address	Idle	Idle
Word 5 of block 0	AF	Address 1	Dummy Address 1'	Dummy Address 1
Word 6 of block 0	AF	Address 2	Dummy Address 2	Dummy Address 2
Word 7 of block 0	VF	Short Message Vector (for Network Address)	VF ^b	VF ²
Word 0 of block 1	VF	Vector (for Address 1,2)	Numeric Vector (for Dummy Address 1,2)	Numeric Vector (for Dummy Address 1,2)
Word 1 of block 1	VF	Message	Dummy Message	Dummy Message
Word 2 of block 2	MF	Message	Dummy Message	Dummy Message
:	:	:	:	:
:	IB	Idle	Idle	Idle
:	:	:	:	:

- BIW101 System Message: Time Instruction,
Seconds Adjust: 0,
Daylight Savings: No (Standard Time),
Local Time zone: Greenwich Meridian
- Vector Type: Short Message/Tone Only,
Message Type: 3 Numeric Characters (000) with Short Address

where,

BI: Block Information
AF: Address Field
VF: Vector Field
MF: Message Field
IB: Idle Block

NOTE If the firmware revision of the 8648A option 1EP is B.04.08 or below, the contents in each phase are shown in the following table:

- 6400 bps, 4-level FSK
- Call in Phase: A
- Address Type: Long Address
- Roaming Mode: SSID, NID

	Field	Phase A	Phase B, C	Phase D
Word 0 of block 0	BI	Block Info	Dummy Block Info	Dummy Block Info
Word 1 of block 0	BI	BIW000	Idle	Idle
Word 2 of block 0	BI	BIW111	Idle	Idle
Word 3 of block 0	BI	Idle	Idle	BIW101
Word 4 of block 0	AF	Network Address	Idle	Idle
Word 5 of block 0	AF	Address 1	Dummy Address 1'	Dummy Address 1
Word 6 of block 0	AF	Address 2	Dummy Address 2	Dummy Address 2
Word 7 of block 0	VF	Short Message Vector (for Network Address)	Idle	Idle
Word 0 of block 1	VF	Vector (for Address 1,2)	Numeric Vector (for Dummy Address 1,2)	Numeric Vector (for Dummy Address 1,2)
Word 1 of block 1	VF	Message	Dummy Message	Dummy Message
Word 2 of block 2	MF	Message	Dummy Message	Dummy Message
:	:	:	:	:
:	IB	Idle	Idle	Idle
:	:	:	:	:

where,

BI: Block Information
AF: Address Field
VF: Vector Field
MF: Message Field
IB: Idle Block

POCSAG

Setting the Data Rate and Pager Type The parameter menu for the data rate and the pager type looks like the following:

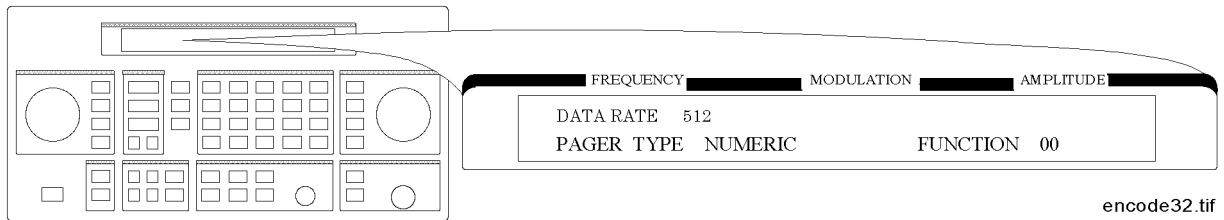

- DATA RATE

512	512 bps
1200	1200 bps
2400	240012 bps

- PAGER TYPE

NUMERIC:	Numeric type
TONE ONLY:	Tone only type
ALPHANUM 7BIT:	7-bit coded alphanumeric type entered by hex-binary code
ALPHANUM 8BIT:	8-bit coded alphanumeric type entered by hex-binary code
ALPHANUMERIC:	7-bit coded alphanumeric type

NOTE The ALPHANUM 7BIT and ALPHANUM 8BIT types can be used for displaying two-byte special characters, for example, Chinese characters, through a conversion table.

The following examples show how the actual bit streams are transmitted if “B0A1” is set to the message (MESSAGE NO. 6):

For ALPHANUM 8BIT

	First Byte								Second Byte							
	MSB				LSB				MSB				LSB			
Bit number	b8	b7	b6	b5	b4	b3	b2	b1	b8	b7	b6	b5	b4	b3	b2	b1
Bit streams	1	0	1	1	0	0	0	0	1	0	1	0	0	0	0	1
Characters	B 0								A 1							

For ALPHANUM 7BIT

The eighth bit (b8) is ignored as follows:

	First Byte							Second Byte						
	MSB			LSB				MSB			LSB			
Bit number	b7	b6	b5	b4	b3	b2	b1	b7	b6	b5	b4	b3	b2	b1
Bit streams	0	1	1	0	0	0	0	1	0	1	0	0	0	1
Characters	B	(3)	0					A	(2)	1				

When converting the binary data stream to 2-level FSK, the first bit out becomes the least significant bit (LSB) of the 2-level symbol with the following bit the most significant bit (MSB) of the symbol.

Setting the Message The message menu looks like the following:

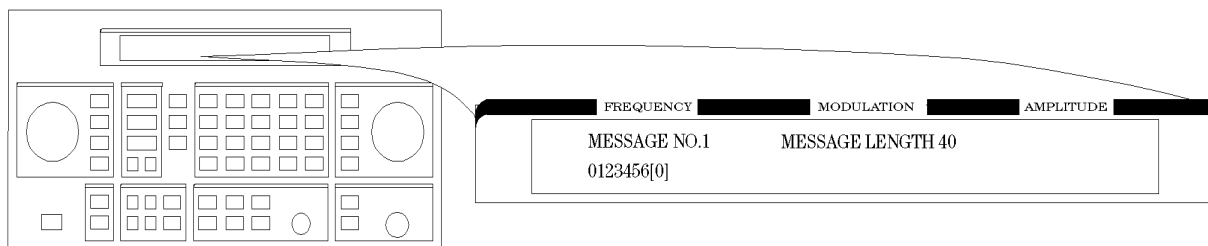

encode4

- MESSAGE NO. is defined as the following where “X” represents the phase setting:
 0: Arbitrary message set from the external controller using the GPIB capability. The data must be entered in units of works. Refer to “[SOURCE]:PAGING [:FORMat]:[POCSag | FLEX | FTS]:ARbitrary:DEFine <NR1>, <NR1>, ..., <NR1>” and “Using the Buffer Memory for the Arbitrary Messages” in Chapter 2.
 This arbitrary message buffer is divided into multiple segments by assigning

- **MODE** determines whether the message will be output once or multiple times when **INCR SET (START/STOP)** is pressed.
 - SINGLE:** Outputs the message once.
 - BURST:** Outputs the message the number of times specified in the **BURSTS** field (3 times in this example).
 - CONT:** Outputs the message continuously until the **INCR SET (START/STOP)** key is pressed a second time.
- **AMPLITUDE** sets the signal output level of the carrier.
- **BURSTS** sets the number of times the message will be transmitted. This parameter is displayed only when the **MODE** parameter is set to **BURST**. The allowable range is 1 to 255.
- **RF OFF** is displayed below the amplitude setting when the RF output is turned off. To toggle the RF signal output on and off, press **RF ON/OFF**.
- **HOLD** is displayed when the step attenuator is held at its current range setting. To toggle the attenuator hold function on and off, press **ATTN HOLD**.

Entering the Pager Capcode (Address) The pager code menu looks like the following:

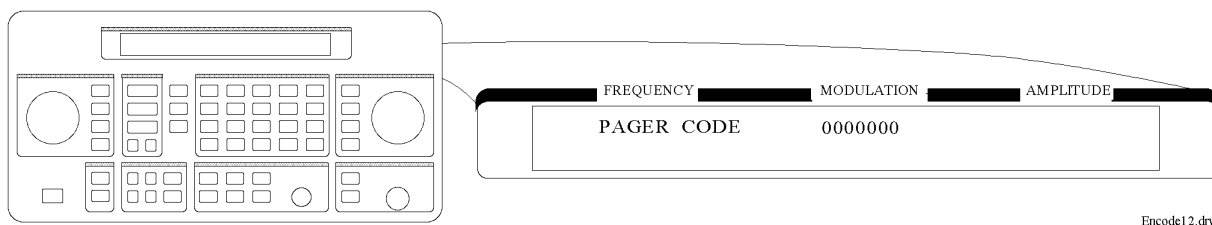

Encode12.drw

- **PAGER CODE** accepts only numeric characters up to 7 digits.
Use the numeric keys to enter the capcode. Terminate your entry with the **MHz/dB(m) (ENTER)** key.

Message During Encoding To start and stop encoding after selecting all pager encoder parameters, press the **INCR SET (START/STOP)** key. The following display is shown during encoding a pager under test.

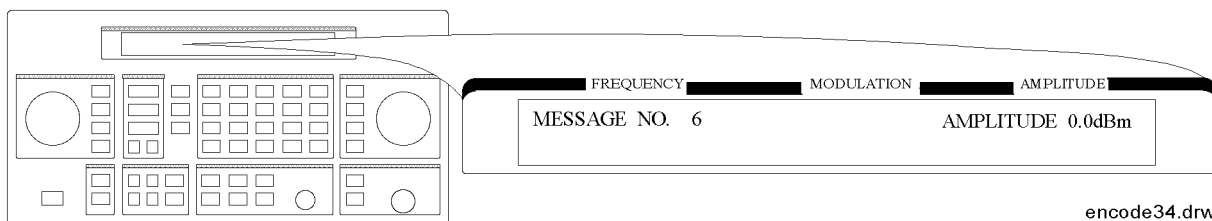

encode34.drw

NOTE If the RF output is turned off, **AMPLITUDE** \times .xdBm will be substituted for **RF OFF**. While encoding, the blinking cursor is on the first character A of **AMPLITUDE** or R of **RF OFF**.

RESYNC

Setting the Encoding Mode The following parameters must be set to activate the resynchronization function for a FLEX/FLEX-TD pager under test:

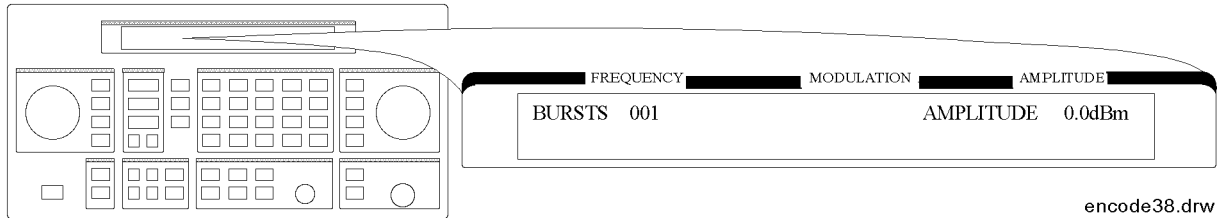

- **BURSTS** defines the number of data to make a pager resynchronized with this pager encoding signal. One burst is 1.92s. The allowable range is 000 to 256. 0 represents the continuous mode.

NOTE This setting is required only when RESYNC is selected in the format menu. The ↑ (PREV) and ↓ (NEXT) keys toggle the format menu and this BURSTS menu. No other menus are displayed.

Message During Resynchronizing To start and stop encoding after selecting all pager encoder parameters, press the INCR SET (START/STOP) key.

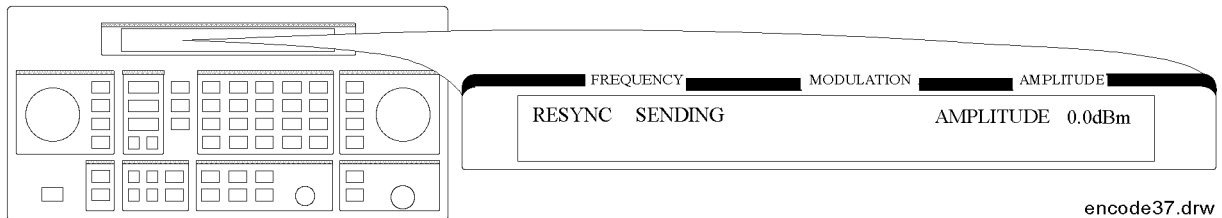

NOTE If the RF output is turned off, AMPLITUDE x.xdBm will be substituted for RF OFF. While encoding, the blinking cursor is on the first character A of AMPLITUDE or R of RF OFF.

PN15

Setting the Data Range If PN15 modulation is selected in the format menu, the following parameters must be set to complete the pager encoder setup process.

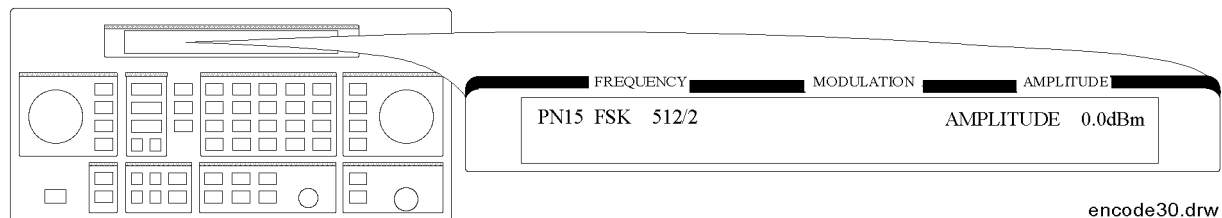

- DATA RATE

512/2:	512 bps, 2-level FSK
1200/2:	1200 bps, 2-level FSK
1600/2:	1600 bps, 2-level FSK
2400/2:	2400 bps, 2-level FSK
3200/2:	3200 bps, 2-level FSK
3200/4:	3200 bps, 4-level FSK
6400/4:	6400 bps, 4-level FSK

NOTE This setting is required only when PN15 is selected in the format menu. The ↑ (PREV) and ↓ (NEXT) keys toggle the format menu and this PN15 FSK data rate menu. No other menus are displayed.

Message During Encoding To start and stop encoding, press the INCR SET (START/STOP) key.

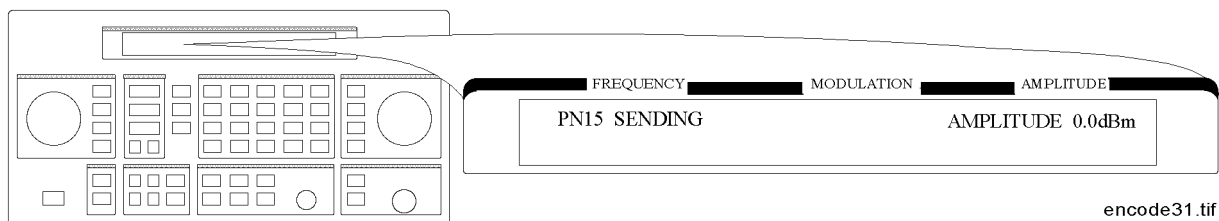

NOTE If the RF output is turned off, AMPLITUDE x.xdBm will be substituted for RF OFF. While encoding, the blinking cursor is on the first character A of AMPLITUDE or R of RF OFF.

SERVICE This function is used for servicing the 8648a Option 1EP, and provides a continuous FSK signal.

Setting the Data Rate The following parameter must be set to activate the service function:

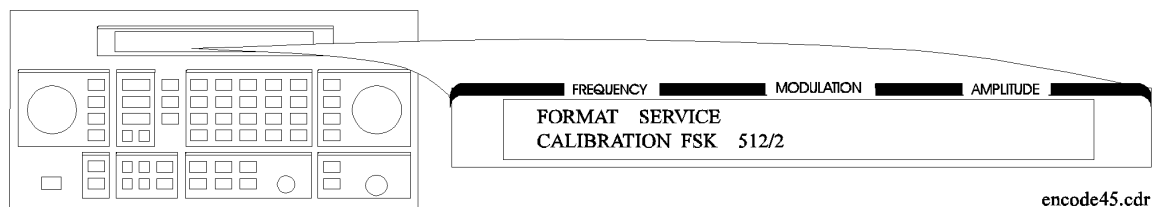

- CALIBRATION FSK is one of the data rates as follows:

512/2:	512 bps, 2-level FSK
1200/2:	1200 bps, 2-level FSK
1600/2:	1600 bps, 2-level FSK
2400/2:	2400 bps, 2-level FSK
3200/2:	3200 bps, 2-level FSK
3200/4:	3200 bps, 4-level FSK
6400/4:	6400 bps, 4-level FSK

NOTE This setting is required only when SERVICE is selected in the format menu. The \uparrow (PREV) and \downarrow (NEXT) keys toggle the blinking cursor between the format parameter and this CALIBRATION FSK parameter. No other menus are displayed.

Message During Servicing To start and stop encoding, press the INCR SET (START/STOP) key.

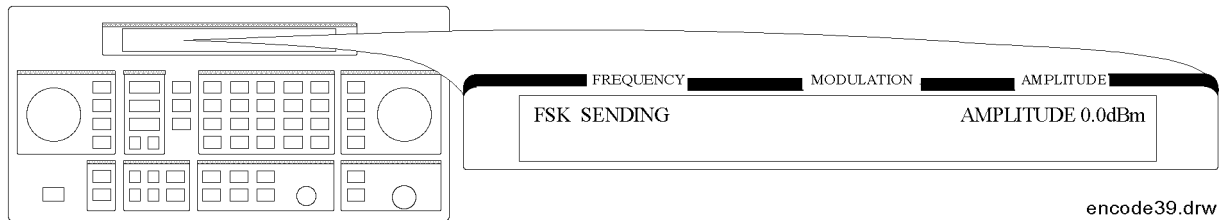

NOTE If the RF output is turned off, AMPLITUDE x.xdBm will be substituted for RF OFF. While encoding, the blinking cursor is on the first character A of AMPLITUDE or R of RF OFF.

Pulse Modulation

NOTE Pulse modulation is valid only for instruments with Option 1E6.

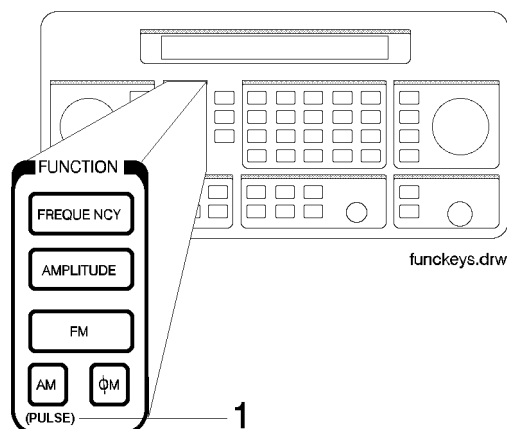

1. PULSE

To select pulse modulation, press **AM (PULSE)** twice. If RF is on, the display will look like the following representation. The **MOD ON/OFF** key enables or disables the pulse modulator.

When the instrument is in the pulse modulation mode, pulse modulation should be turned off using **MOD ON/OFF** before switching off the instrument. If the instrument is switched off while the pulse modulation mode is turned on, the instrument will power up with no RF output.

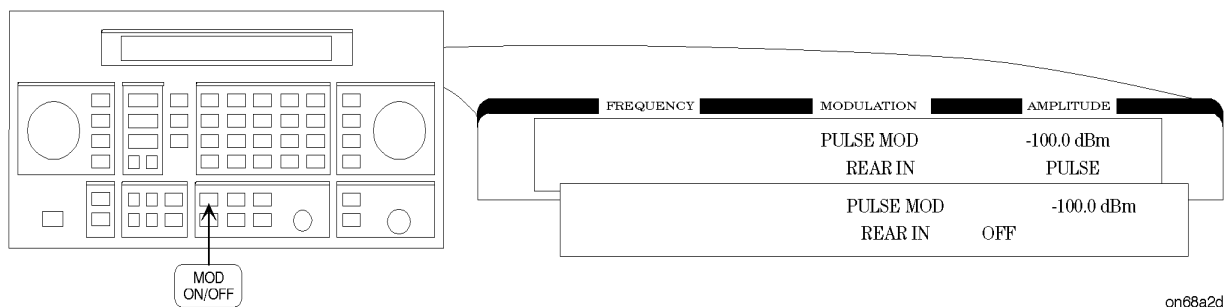

NOTE The word **PULSE** is shown in the **AMPLITUDE** portion of the display when pulse modulation is enabled (**MOD ON/OFF**) and the RF is turned on (**RF ON/OFF**). In this case, no RF will be present at the RF output unless a TTL-high signal is applied to the rear-panel **PULSE IN** connector.

The following keys are invalid when the pulse modulation screen is visible:

- INT 400 Hz
- INT 1kHz
- EXT AC
- EXT DC
- 1kHz+EXT DC

Increment Set

1. INCR SET

Press **INCR SET** to view or change the increment set value for the currently active function (the active function is the last function key you press; **FREQUENCY**, **AMPLITUDE**, **FM**, **AM**, or **ΦM**). When you press **INCR SET**, \uparrow is displayed between the value and the units. The \downarrow indicates that the displayed value is the increment set value.

NOTE An increment value cannot be set for the knobs or the memory recall arrow keys.

Increment Set Ranges	
Function	Range
Frequency	1 Hz to 999.75 MHz
Amplitude	> 0.0 to 149.0 dB (8648A)
Amplitude	> 0.0 to 150.5 dB (8648B/C/D)
FM Deviation	> 0.0 to 100 kHz
AM Depth	> 0.0 to 100%
ΦM Deviation	> 0.0 to 10.0 Radians
Internal Audio Generator (Options 1EP and 1E2 only)	0.01 to 1.0 kHz

NOTE It is possible to set an increment value of greater resolution than can be displayed or than the hardware can respond to. However, the instrument records each arrow key press and will respond after the appropriate number of presses.

START/STOP Encoding If Option 1EP is present and the signal generator is in the ENCODER mode, the INCR SET key functions as a START/STOP key to start or stop the pager encoding when in the pager encoder mode.

PREV and NEXT If Option 1EP is present and the signal generator is in the ENCODER mode, the \uparrow and \downarrow keys function as the PREV and NEXT keys to change the blinking first character between each parameter when in the pager encoder mode.

Data

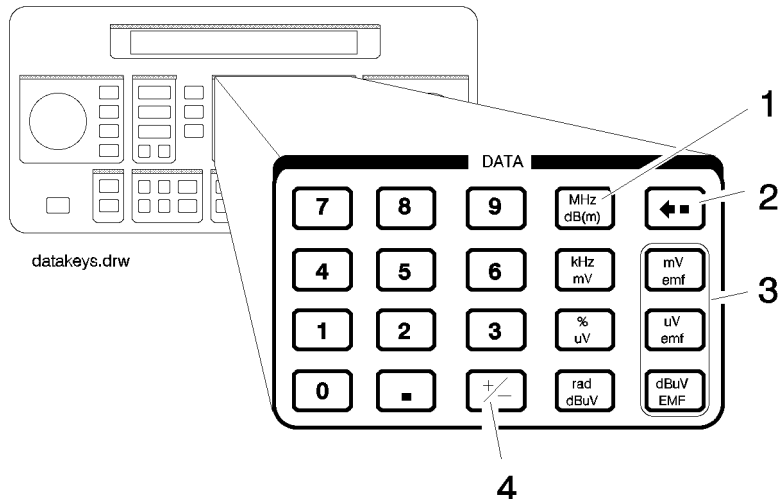

1. MHz/dBm, kHz/mV, %/ μ V, rad/dB μ V

Press a units key after you enter a value. This terminates the entry.

Note that the units keys in the left column are each labeled with an amplitude unit on the bottom and a frequency or modulation unit on the top. The instrument applies the appropriate unit for the function value you are entering. The bottom key in the row for instance, terminates a Φ M entry in radians or an amplitude entry in dB μ V.

NOTE Memory register selections, sequence selections, and HP-IB address entries do not require a units key to terminate the entry. These entries are automatically terminated after the last digit is entered.

Units Conversion You can change the units of the displayed frequency or amplitude value by selecting the FUNCTION (frequency or amplitude) and then pressing a units key. The instrument will convert the displayed value to the equivalent value for the units key you pressed.

ENTER If Option 1EP is present and the signal generator is in the ENCODER mode, the MHz dB(m) key functions as an ENTER key. The ENTER key must be used to store any numeric or alphabetic characters entered by way of the DATA and MODULATION source blocks.

SHIFT If Option 1EP is present and the signal generator is in the ENCODER mode, the rad dB μ V key functions as a SHIFT key. This key lets you input alphabetical characters using the DATA and MODULATION SOURCE blocks when in the pager encoder mode.

2. Backspace

Press \leftarrow when entering a numeric value to backspace and remove the last digit entered.

3. emf

Press these keys to display the amplitude value indicated on the key label in electromotive force units. Emf is the RF output voltage with no load. It is twice the output voltage with a 50 ohm load.

4. ±

Press this key at any time while you are entering an amplitude or reference offset value to change the sign of the value.

Instrument Preset

POWER ⇐

Turn the instrument on while pressing the backspace key (⇐) to perform an instrument preset. The instrument will power up to factory-defined settings shown in the following table. Save and recall registers are not affected by this operation.

POWER DEL

Turn the instrument on while pressing the memory DEL key to perform a clear memory. This function erases all save/recall registers, sets the GPIB address to 19, and performs an instrument preset where the instrument powers up to factory-defined settings shown in the following table.

NOTE This will cause an error message to appear on the display: 627 Battery RAM failure: memory lost. This is normal.

Instrument Preset Settings		
Function	Parameter	Setting
RF Frequency	Frequency	100 MHz
	Increment	10 MHz
	Reference	0.0 MHz
RF Amplitude	Power Level	-136 dBm
	Increment	1.0 dBm
	Reference	0.0 dBm
FM	Input	Internal
	Frequency	1 kHz
	Coupling	AC
	State	Off
	Deviation	30%
	Increment	0.1 kHz
AM	Input	Internal
	Frequency	1 kHz
	State	Off
	Depth	30%
	Increment	0.1%
ΦM	Input	Internal
	Frequency	1 kHz
	Coupling	AC
	State	Off
	Deviation	1.0 radians
	Increment	0.1 radians
RF	State	Off
Attenuator	Coupling	Off
Pulse (Option 1E6)	State	Off

Instrument Preset Settings		
Function	Parameter	Setting
Pager Encoding (Option 1EP)	FORMAT	FLEX
	POLARITY	NORMAL
	FILTER	ON
	DATA RATE	1600/2 (for FLEX/FLEX-TD) 512 (for POCSAG)
	PAGER TYPE	NUMERIC
	VECTOR TYPE	STANDARD
	BLOCKING LENGTH	1BIT
	FUNCTION	00
	MESSAGE NO.	1
	MESSAGE LENGTH	40
	MODE	SINGLE
	BURSTS	1
	IMMEDIATE STOP	OFF
	HEADER	ON
	TERMINATOR	ON
	PAGER CODE	A0000001 (for FLEX/FLEX-TD) 0000000 (for POCSAG)
	ADDRESS TYPE	SHORT
	ADDRESS1	0032769
	ADDRESS2	0000000
	CYCLE	0
	FRAME	0
	PHASE	A
	COLLAPSE CYCLE	4
	REPEAT	0
	INTERNAL AUDIO GENERATOR	1
	START FRAME/BATCH	0
	STOP FRAME/BATCH	127
DUMMY CALL	OFF	
ADDRESS1 (DUMMY CALL)	0032769	
ADDRESS2 (DUMMY CALL)	0000000	

Instrument Preset Settings		
Function	Parameter	Setting
Modulation Generator (Option 1E2)	FREQUENCY	1.00 kHz
	SHAPE	SINE

GPIB

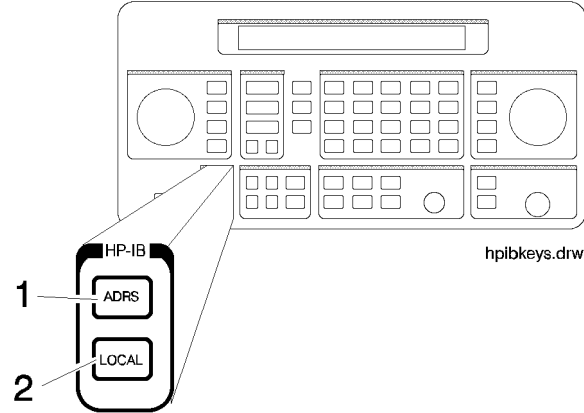

1. ADRS

Press **ADRS** to view the instrument's GPIB address setting in the second line of the **FREQUENCY** display.

To change the address, press **ADRS** and a two-digit number. For example, enter 01 to set the address to 1.

Acceptable HP-IB addresses are 00 through 30.

2. LOCAL

Press **LOCAL** to return to front-panel operation when the instrument has been set for remote operation. The **SEQ** and **REG** fields will replace the HP-IB status indications in the second line of the **FREQUENCY** display when the instrument is returned to local operation.

Memory

The memory keys allow you to save instrument settings into memory registers and recall the registers in a numeric sequence.

Up to 10 register sequences can be defined (0 through 9). A sequence can contain up to 100 registers (00 through 99). There are a total of 300 registers available in the instrument. The registers can be used in the sequences in any combination (such as 10 sequences of 30 registers each, or 3 sequences of 100 registers each) as long as the total does not exceed 300 registers. It is not possible to have all 10 sequences each contain 100 registers as that would be 1000 registers. (If Option 1EP is present, there are a total of 70 registers available.)

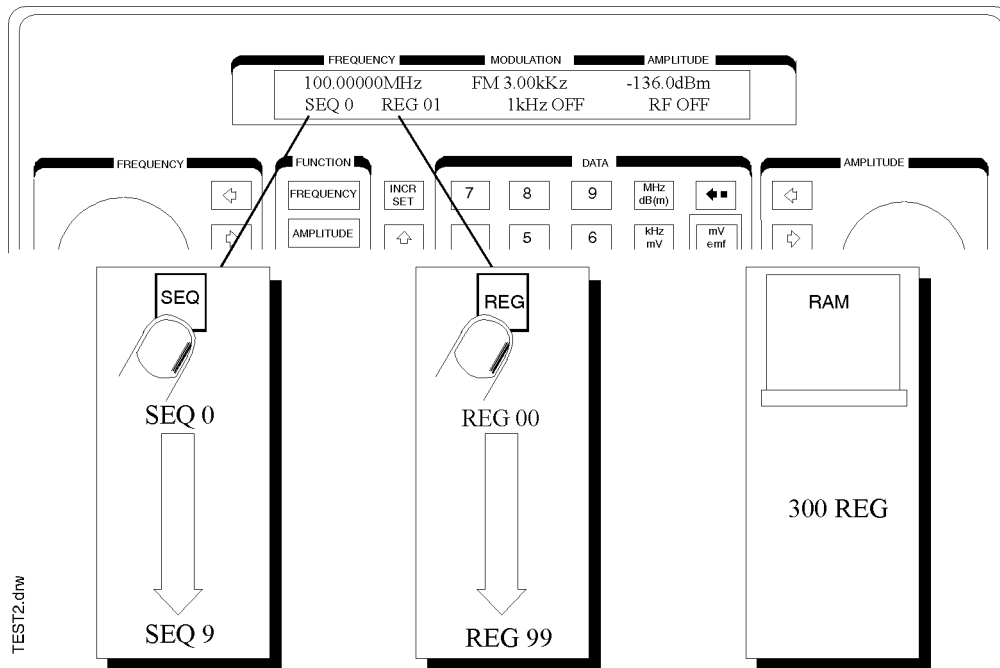

Memory key entries are automatically terminated after you enter the last digit. Register key entries (**SAV**, **DEL**, and **REG**), require two digits. Sequence key entries (**SEQ**) require one digit.

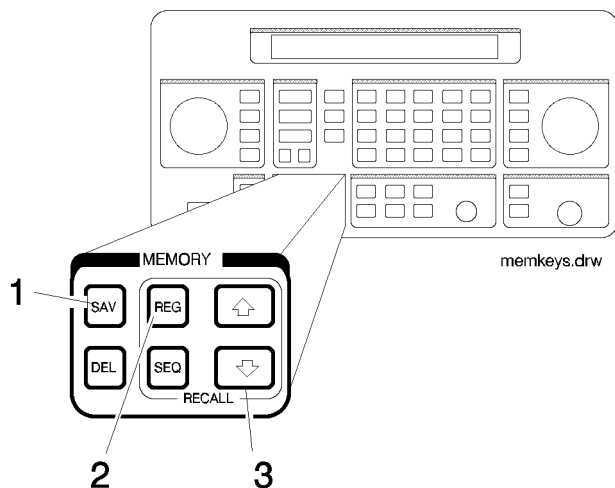

1. SAV

Press SAV and a register number (00 through 99) to save the current operating settings in a memory register. All front-panel settings except the knob digit positions and the GPIB address will be saved in the register.

When you press the **SAV** key, a message is displayed to tell you the total number of registers still available.

When you save a register, it is assigned to the currently selected sequence. (The number of the selected sequence appears in the second line of the FREQUENCY display.) You can only recall a register when the sequence it is assigned to is selected.

(Refer to "4. SEQ" for further information about register sequences.)

NOTE The instrument does not have a copy function for saving registers from one sequence to another.

2. REG

Press REG and a register number (00 through 99) to recall the operating settings saved in that register.

The number of the last register recalled appears in the display along with the number of the currently selected sequence.

You can only recall registers from the currently selected sequence.

To recall a register from another sequence, you must first select the sequence using the **SEQ** key.

If you recall a register remotely in 8656/57-compatible language and nothing has been saved in that register, the instrument preset settings will be restored.

3. Register Recall Arrows

The recall \uparrow and \downarrow keys can be used to select sequences or recall registers. The last key pressed (**SEQ** or **REG**) determines which field is affected by the arrow keys.

(Refer to "4. SEQ" for further information about register sequences.)

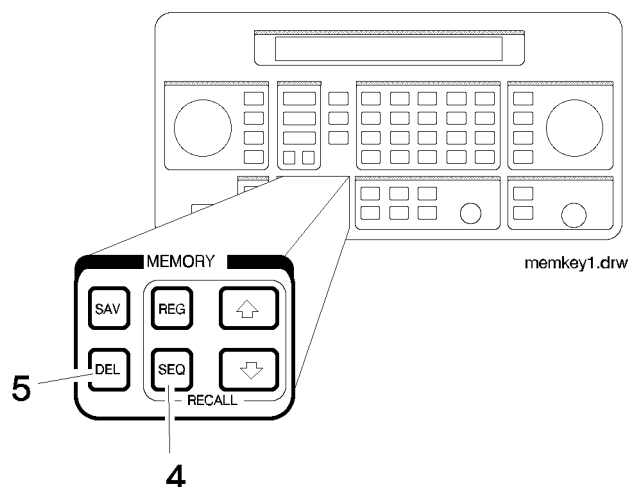

4. SEQ

Press SEQ and a sequence number (0 through 9) to select a register sequence. When you select a sequence, the number of the sequence appears in the display along with the number of the first register saved in the sequence. The instrument is set to the operating settings saved in the first register. If no registers have been saved in the sequence, a message is displayed to let you know.

NOTE Selecting the sequence you are currently in is a quick way to return to the beginning of the sequence

A sequence can include up to 100 registers (00 through 99). There are a total of 300 registers available in the standard instrument and 70 registers in an instrument with Option 1EP (pager encoder) installed. Registers are automatically assigned to the currently selected sequence when they are saved. The registers saved in any given sequence are independent from the registers in any other sequence. This allows you to create up to ten different register sequences. Consequently, it is possible to have up to ten registers with the same number (for example, REG 01) each assigned to a different sequence and each with different operating settings saved in it.

5. DEL

Press DEL and a register number (00 through 99) to delete that register. The specified register is deleted from the currently selected sequence only, but registers in other sequences you have set up are not affected. After you have deleted a register, you will not be able to recall that register number until you have saved operating settings in it again.

NOTE The register number is immediately deleted from the sequence when the delete entry is completed. However, the settings contained in the register are recalled when you delete the register so you can re-save the settings if you need to.

Renumbering the Registers If you use the arrow keys to recall the registers in sequence, the deleted register number will be skipped. If you wish to eliminate the skip, you can do so by moving each register following the deleted register back one register number. To delete an entire sequence, delete each register in the sequence.

Modulation Source

Figure 1-2. Modulation Source Paths (the 1 kHz path is highlighted)

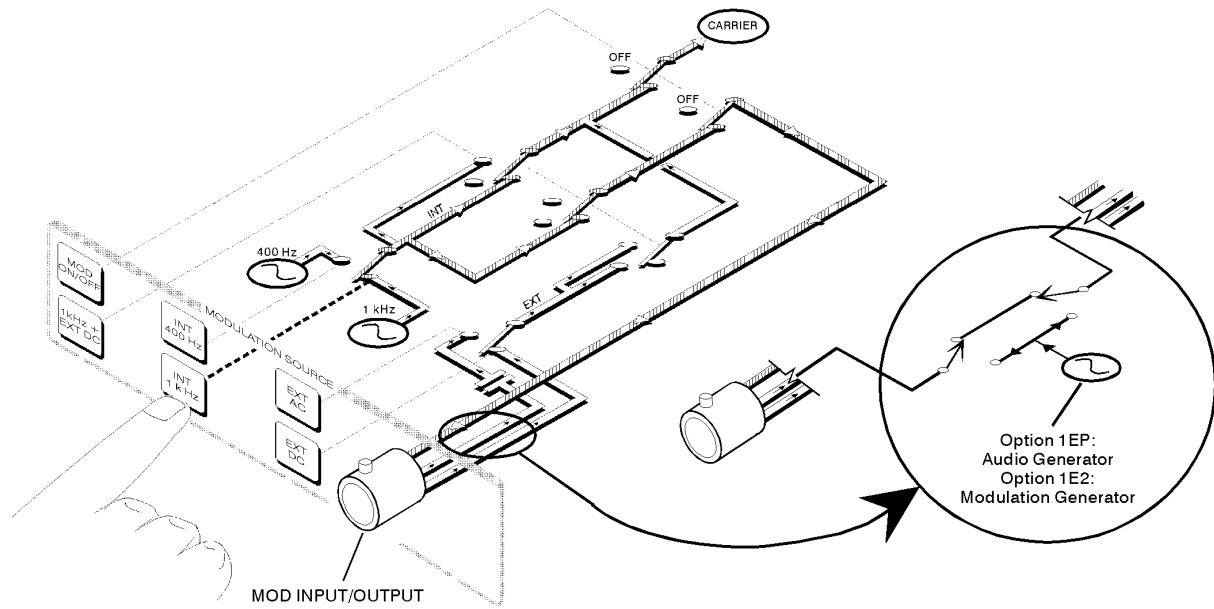

on619bd

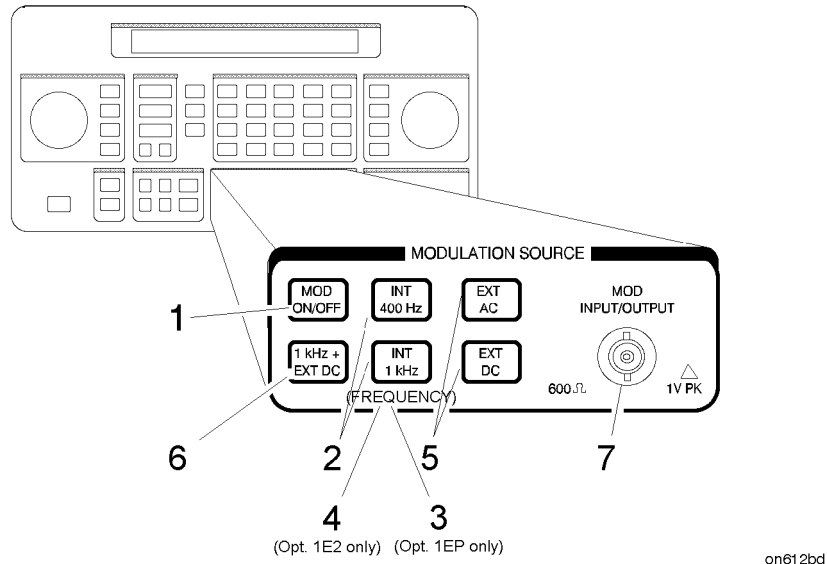

1. MOD ON/OFF

Press MOD ON/OFF to turn on or off the currently-selected modulation mode (AM, FM, Φ M, or pulse). OFF appears in the second line of the MODULATION display when modulation is turned off.

This key also turns on or off the audio output at the MOD INPUT/OUTPUT connector when an internal source (400 Hz or 1 kHz) is selected.

The operation of this key is the same as the MOD ON/OFF key on the 83300A Remote Interface.

2. INT 400 Hz, INT 1 kHz

Press one of these keys to select an internal source for modulating the carrier. The selected source is also output at the MOD INPUT/OUTPUT port as a 1 Vpk signal into 600 ohms.

3. (FREQUENCY), 4. (FREQUENCY/WAVEFORM)

If Option 1EP is present, the INT 1kHz (FREQUENCY) key, or if Option 1E2 is present, the INT 1kHz (FREQUENCY/WAVEFORM) key will toggle between the 1 kHz internal source and the internal variable-frequency generator with its four waveforms. Repetitively pressing the INT 1kHz key toggles between 1kHz (the 1 kHz internal source), SIN (the sine waveform), TRI (the triangle waveform), SQU (the square waveform), and SAW (the saw or ramp waveform).

The frequency of the modulated frequency may be changed by entering the frequency on the keypad and terminating the value with the kHz key. kHz is the *only* valid units key that is accepted. Therefore, to set a frequency of 10 Hz, you must press .01 kHz. The frequency knob will *not* change this frequency. After the frequency is set, toggling the INT 1kHz key only changes the waveform. The frequency remains unchanged.

The acceptable frequency range for the internal variable-frequency generator is 10 Hz to 20 kHz.

Pressing **AM**, **FM**, or Φ **M** allows you to store a variable frequency and waveform for each of these types of modulation. After setting up one of these types of modulation with a frequency/waveform combination, simply pressing that modulation key (**AM**, **FM**, or Φ **M**) recalls the frequency/waveform combination that was set up earlier. For example, an instrument is configured so the AM state is set up with a 2 kHz sine waveform, the FM state is set up with a 500 Hz square waveform, and the Φ M state is set up with a 5 kHz triangle waveform. Then pressing either **AM**, **FM**, or Φ **M** will set the instrument to that modulation type with the frequency/waveform combination to which it was previously set.

NOTE If another key (for example, **FREQUENCY**, **AMPLITUDE**, and so forth) is pressed after a frequency and waveform combination is set, pressing the **INT 1kHz** key once makes the **INT 1kHz** active. Subsequent key presses toggles the instrument through its waveform choices.

5. EXT AC, EXT DC

Press one of these keys to configure the MOD INPUT/OUTPUT port as an ac- or dc-coupled input for modulating the carrier.

Calibrated modulation requires an audio source of 1 Vpk into 600 ohms. For audio source frequencies of less than 10 kHz, a **HI** or **LO** indicator will appear in the second line of the MODULATION display when the level of the source is not within approximately $\pm 5\%$ of 1 Vpk.

Acceptable Frequency Ranges for an External Audio Source		
Modulation	Coupling	Range
FM	EXT AC	1 Hz to 150 kHz
	EXT CC	DC to 150 kHz
Φ M	EXT AC	20 Hz to 10 kHz
AM ^a	EXT AC	1 Hz to 25 kHz
AM ^a	EXT AC	DC to 25 kHz

a. AM bandwidth degrades at carrier frequencies below 1.5 MHz and is not specified.

If you press **EXT DC** while the instrument is already in external dc mode and the FM is on, then the instrument will perform a dc FM calibration. The calibration takes approximately one second. During the calibration the following message appears on the display: DCFM calibration in progress.

6. 1 kHz + EXT DC

Press **1 kHz + EXT DC** to configure the MOD INPUT/OUTPUT port as a dc-coupled input for modulating the carrier along with the internal 1 kHz source.

(Refer also to "3. EXT AC EXT DC" for further information about operation and acceptable ranges.)

NOTE 1 kHz + EXT AC, 400 Hz + EXT DC, and 400 Hz + EXT AC are available only via GPIB.

Setting the Modulation Level When modulating with both an internal and external source, the level of the external source should not exceed 0.5 V peak or 0.5 Vdc. This level will provide one half of the displayed modulation. To set modulation to the level you desire, set the displayed modulation to two-thirds of the desired setting. The external source, set to 0.5 V peak or 0.5 Vdc, will provide the additional one-third of the desired setting (one-half of the instrument's setting).

For example, to set up the modulation for 3 kHz of FM deviation, set the instrument for 2 kHz of FM. The external source, set to 0.5 V peak, will provide another 1 kHz of deviation.

If the external source is set to less than 0.5 V peak, the modulation level provided by the external source will be less than one-half of the displayed modulation. The following equation may be helpful for determining the appropriate modulation level setting for the instrument when the level of the external source is less than 0.5 V.

$$\frac{A}{1 + E} = D$$

Where:

- A = Actual modulation level
- E = External source level
- D = Displayed modulation level

For example, to set up for 3 kHz of FM deviation with an external source set to 0.3 V peak, the instrument's displayed modulation level would be:

$$\frac{3 \text{ kHz}}{1 + 0.3 \text{ V}} = 2.3 \text{ kHz}$$

7. MOD INPUT/OUTPUT

This port outputs a 1 Vpk (into 600 ohms) audio tone when an internal modulation source is selected. When an external modulation input is selected (EXT AC, EXT DC or 1 kHz + EXT DC), it provides the input for a 1 Vpk (into 600 ohms) audio source. (Refer to the preceding table for acceptable frequency ranges.)

RF Output

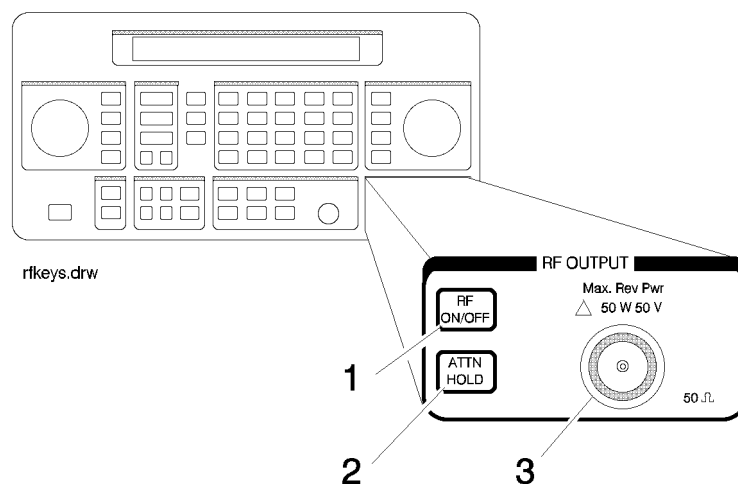

1. RF ON/OFF

Press RF ON/OFF to turn the RF output signal on or off. RF OFF appears in the second line of the AMPLITUDE display when the output signal is off.

The instrument turns off the output signal by switching in the maximum output attenuation (130 dB) and setting the vernier to its lowest setting. This results in approximately 170 dB of carrier isolation.

2. ATTN HOLD

Press ATTN HOLD to hold the step attenuator at its current setting. HOLD appears in the second line of the AMPLITUDE display when the attenuator hold function is on.

When the attenuator hold function is on, amplitude adjustments are limited to the range of the instrument's vernier. The vernier provides 0.1 dB per step adjustment resolution across its specified 10 dB range.

Vernier Ranges The following table, "10 dB Specified Vernier Ranges", provides the upper and lower limits of each vernier range. The instrument's amplitude setting when you press the **ATTN HOLD** key determines which vernier range is used.

The vernier is allowed to over-range and under-range beyond the limits shown in the table when **ATTN HOLD** is selected. However, amplitude settings that exceed the limits may not provide output levels that are within the accuracy specifications of the instrument.

10 dB Specified Vernier Ranges	
Range	Upper and Lower Limits
1	+10.0 dBm ^a to -5.9 dBm
2	-6.0 dBm to -15.9 dBm
3	-16.0 dBm to -25.9 dBm
4	-26.0 dBm to -35.9 dBm
5	-36.0 dBm to -45.9 dBm
6	-46.0 dBm to -55.9 dBm
7	-56.0 dBm to -65.9 dBm
8	-66.0 dBm to -75.9 dBm
9	-76.0 dBm to -85.9 dBm
10	-86.0 dBm to -95.9 dBm
11	-96.0 dBm to -105.9 dBm
12	-106.0 dBm to -115.9 dBm
13	-116.0 dBm to -127.0 dBm
14	-127.1 dBm to -136.0 dBm

a. +13 dBm for 8648B/C/D

3. RF OUTPUT

The following table shows the reverse power protection for the RF output port of each instrument model. When the instrument senses a reverse-power signal, it turns the RF output off, the step attenuator to maximum attenuation, and the vernier to its lowest setting. A message appears in the second line of the display when the reverse power protection has been activated.

After you have removed the reverse-power signal from the RF output, press the **RF ON/OFF** key to turn the output signal on again.

CAUTION Applying a signal source to the RF output port that exceeds the power level listed or maintaining a signal source at the RF output for an extended period of time may damage the instrument.

Reverse Power Protection	
≤ 2000 MHz	50 watts into 50Ω
> 2000 MHz	25 watts into 50Ω

Rear Panel

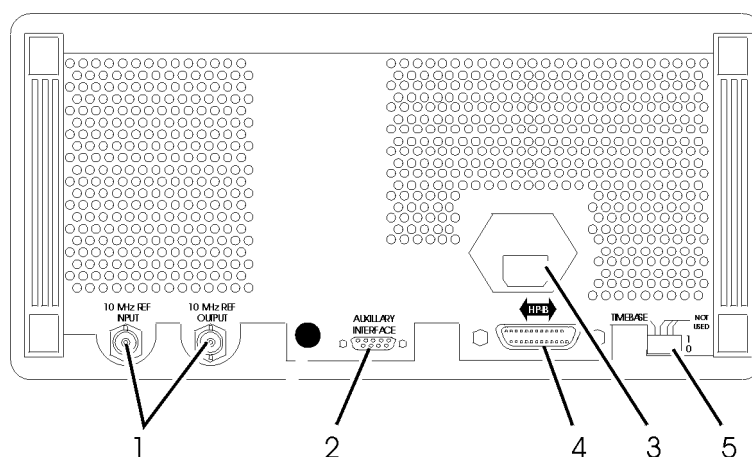

ot71a

1. 10 MHz REF INPUT and OUTPUT

These connectors provide the input and output ports for the instrument's timebase reference. The instrument will lock to a 2 MHz, 5 MHz, or 10 MHz external reference source connected to the input that is within ± 5 ppm. When the internal timebase is being used, the output connector provides a 10 MHz, 1 Vrms level signal.

2. DISPLAY CONTRAST

This knob controls the front panel display contrast. Display contrast can be optimized for viewing the display from above, below, or directly in front of it.

3. AUXILIARY INTERFACE

Connect the 83300A Remote Interface or the 83301A Memory Interface to this connector for operation with the instrument. Refer to "Remote Interface" and "Memory Interface" in

this section for information about operating these devices.

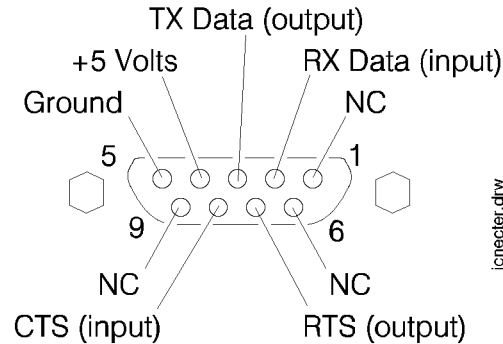

4. Line Voltage Connector

For information about the line voltage connector or fuse replacement, refer to Chapter 3, "Installation."

5. HP-IB Connector

This is an IEEE 488.1-1987 connector for controlling the instrument via an external controller. For information about GPIB operation of the instrument, refer to Chapter 2, "GPIB Programming."

6. TIMEBASE ADJ and Language Switches

Position one of this switch places the instrument in the timebase adjustment mode. For the timebase adjustment procedure, refer to Chapter 7, "Adjustments."

Position two of this switch allows you to set the language for remote programming to either 8656/57-compatible language (1) or to SCPI (0). The language switch is read once at power-up.

7. External Pulse Input

This connector provides the input for an external TTL signal which is used by the pulse modulator to modulate the RF signal off and on. This connector is on Option 1E6 only.

Remote Interface (Accessory)

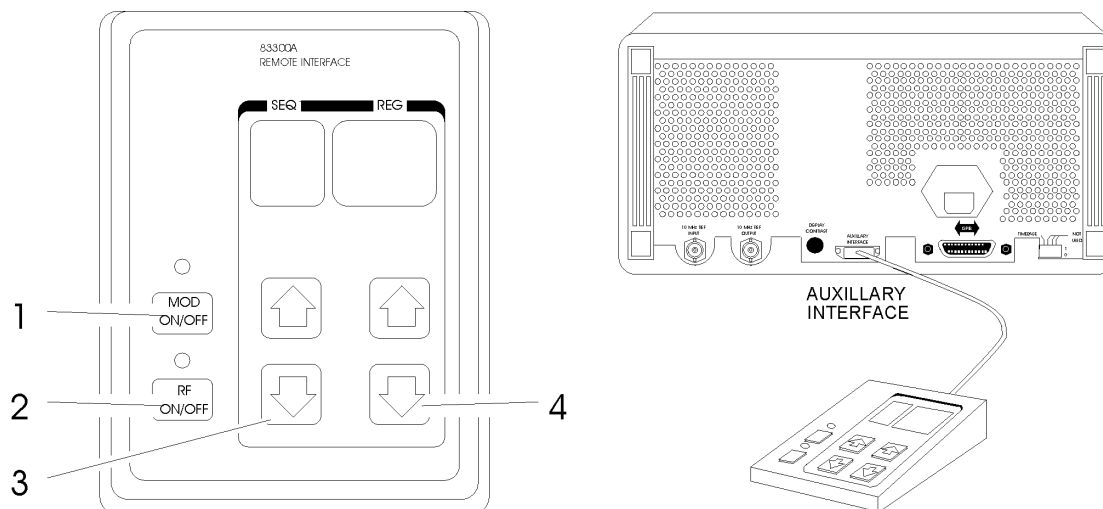

ot72a

1. MOD ON/OFF

Press **MOD ON/OFF** to turn on or off all modulation (internal and external) to the RF carrier. When modulation is turned off, the LED above the key is off and **OFF** appears in the second line of the instrument's **MODULATION** display.

This key also turns on or off the audio output at the **MOD INPUT/OUTPUT** port when an internal source (400 Hz or INT 1 kHz) is selected.

2. RF ON/OFF

Press **RF ON/OFF** to turn the RF output signal on or off. When the RF output signal is turned off, the LED above the key is off and **RF OFF** appears in the second line of the instrument's **AMPLITUDE** display. There is approximately 170 dB of carrier isolation when the output is off.

3. Sequence Selection Arrows

Press \uparrow or \downarrow to select the next or previous sequence of registers. The sequences are selected in numeric order. The number of the selected sequence appears in the second line of the **FREQUENCY** display. When a sequence is selected, the first register in the sequence is recalled. When a sequence is selected that has no registers saved in it, two dashes (- -) will appear in the **REG** field.

4. Register Recall Arrows

Press \uparrow or \downarrow to recall the operating settings saved in the registers in the currently selected sequence. The number of the last register accessed appears in the REG field.

If two dashes (- -) appear in the REG field, a sequence that has no registers saved in it has been selected.

After the last register in the sequence has been recalled, the register count will begin again at the first register saved in the sequence.

(Refer to “MEMORY” in this section for further information about register sequences.)

Memory Interface (Accessory)

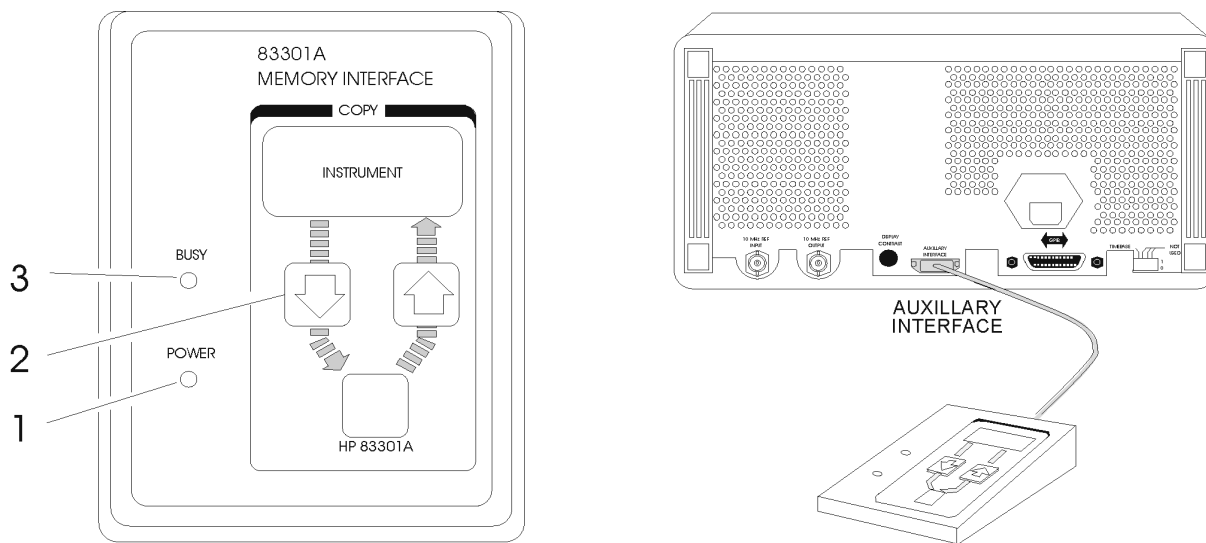

ot73a

1. POWER

This light indicates that power is being supplied to the 83301A. It should light when the cable is connected to the AUXILIARY INTERFACE connector on the rear panel of the instrument. If it does not light, refer to Chapter 5, "Service."

2. Copy Arrow Keys

Making a Copy When the 83301A is connected to the instrument, press the ↓ to copy all of the memory registers saved in the instrument into the 83301A's memory. After you have pressed an arrow key, you must also press the **SAV** key on the instrument's front panel to begin the copy process. Press the ↑ and **SAV** keys to copy the memory registers stored in the 83301A into the instrument's memory.

NOTE Copying memory into the instrument or the 83301A causes any existing memory registers in the receiving device to be erased. It does not effect the memory in the sending device, however.

3. BUSY

This light is turned on while memory registers are being copied from one device to another. Attempting to operate the instrument or memory interface while this light is on may cause the memory data to be corrupted. The light will turn off when the copy is complete.

1c Operation messages

This chapter provides descriptions for both front panel and GPIB operation messages. For information about service messages, numbered 500 and above, refer to Chapter 5c, 'Service Error Messages'.

Front Panel Operation Messages

SEQ X SAVE __ XXX registers available

This message is displayed when the **SAV** key is pressed to inform you of how many registers are still available. If a register is available, enter the two-digit number of the register you wish to save.

SEQ X REG __ XXX has not been saved

This message is displayed when an attempt is made to recall a register that has not been saved in the sequence. Check to be sure that the appropriate sequence is selected and that you have entered the correct register number.

SEQ X DEL __ Enter number to delete

This message is displayed when the **DEL** key is pressed. Enter the number of the memory register you wish to delete. When a register is deleted, the settings saved in it are erased and the register number is removed from the sequence.

SEQ X has no registers saved in it

This message is displayed when a sequence is selected that has no registers saved in it. If you wish to save registers in the sequence, set up the instrument, press the **SAV** key, and enter a two-digit register number.

0 No external dc coupling for PM

0
1 This message is displayed when PM is selected and **EXT DC** or **1 kHz + EXT DC** is also selected. DC coupling of an external source is not possible for PM. If you press **1 kHz + EXT DC** you will actually get 1 kHz and external ac. Or, select **EXT AC** coupling for PM. Additional internal plus external modulation capabilities (such as **1 kHz + EXT DC**) are available through GPIB control of the instrument; refer to Chapter 2, "GPIB Programming".

0 Modulation exceeds deviation range

0
2 This message is displayed when modulation is set to a level that exceeds the operating range of the instrument. This condition occurs when a modulation level is entered that is out-of-range for the current RF frequency setting, or when the RF frequency setting is changed and the modulation setting is out-of-range for the new setting.

0 There are no registers available

0
3 This message is displayed when an attempt is made to save a memory register and all of the instrument's memory registers have already been used. Delete any unneeded registers in order to save new ones. Deleting registers from any sequence will make them unavailable for saving new settings in the sequence you are using.

0 Invalid units selection

0
4 This message is displayed when a units key is pressed that is not valid for the active function. Check that the units key you select is labeled with the appropriate units for the value you are entering.

0 Increment value entry out of range

0
5 This message is displayed when the **INCR SET** key is pressed and a value is entered that is not within the increment value range for the active function. Refer to “Increment Set” in Chapter 1b, “Operation Reference”, for a listing of the increment value ranges.

0 End of increment range

0
6 This message is displayed when the \uparrow or \downarrow increment arrow key is pressed and the increment value does not set the instrument to a setting that is within the instrument’s allowable range. To view or change the increment value, press the **INCR SET** key. Refer to “Increment Set” in Chapter 1b, “Operation Reference”, for a listing of the increment value ranges.

0 Entered value out of range

0
7 This message is displayed when a value is entered that does not set the RF output signal within the instrument’s allowable range. Refer to “Function” in Chapter 1b, “Operation Reference”, for information on the instrument’s allowable ranges.

0 End of knob range

1
0 This message is displayed when the knob is turned but changing the selected digit would set the instrument to a value that is not within its allowable range.

0 Amplitude exceeds ATTN HOLD limits

1
1 This message is displayed then **ATTN HOLD** is on and the amplitude is set to a level that exceeds the vernier range limits by greater than 5 dBm. Exceeding the 10 dB vernier range of an attenuator hold setting causes the output level accuracy to degrade. For information about the vernier ranges and limits, refer to “RF Output” in Chapter 1b, “Operation Reference”.

0 DCFM calibration in progress

1
7 This message is displayed when FM is selected and **EXT DC** is also selected. The instrument will perform a dc FM calibration and this message is displayed during the calibration.

0 Press **SAV** to copy memory FROM 8647/8

2
0 This message is displayed when the \downarrow key is pressed on an 83301A memory Interface connected to the instrument. Press the **SAV** key to copy the memory registers saved in the instrument into the memory interface.

0 Copying registers from 8647/8

2 This message is displayed while the memory registers are being copied from the
1 instrument to the 83301A Memory Interface.

0 Press **SAV** to copy memory TO 8647/8

2 This message is displayed when the \uparrow key is pressed on an 83301A Memory Interface
2 connected to the instrument. Press the **SAV** key to copy memory registers that had been
saved in the memory interface into the instrument.

0 Copying registers to 8647/8

2 This message is displayed while the memory registers are being copied from the 83301A
3 memory Interface to the instrument.

0 Invalid data in Memory Interface

2 This message is displayed when the instrument detects that the 83301A Memory
4 Interface does not contain valid memory register data. Try copying a memory register
into the memory interface first, then initiate a copy from the memory interface to the
instrument again.

0 Communication failure: copy aborted

2 This message is displayed when the instrument is not able to successfully copy memory
5 registers between the instrument and the 83301A Memory Interface. This message will
be displayed if the cable connecting the instrument to the primary interface is
disconnected during the copy process.

0 Memory copy was successful

2 This message is displayed when the instrument has successfully copied the memory
6 registers between the instrument and the 83301A Memory Interface. When this
message is displayed, the copy process is complete and you can disconnect the memory
interface from the instrument.

GPIB Command Messages

- Invalid character

1
0 A syntactic element contains a character which is invalid for that type; for example, a
1 header containing an ampersand, SETUP&. This error might be used in place of errors
-121, -141, and perhaps some others.

- Syntax error

1
0 An unrecognized command or data type was encountered. For example, a string was
2 received when the device does not accept strings. Additional information is available
over GPIB.

- Invalid separator

1
0 The parser was expecting a separator and encountered an illegal character. For example,
3 the semicolon was omitted after a program unit, *EMC1;CH1:VOLTS5.

- Data type error

1
0 The parser recognized a data element different than one allowed. For example, numeric
4 or string data was expected but block data was encountered.

- GET not allowed

1
0 A Group Execute Trigger was received within a program message (see IEEE 488.2.7.7).
5

- Parameter not allowed

1
0 More parameters were received than expected for the header. For example, the *EMC
8 common command only accepts one parameter, so receiving *EMC0,1 is not allowed.

- Missing parameter

1
0 Fewer parameters were received than required for the header. For example, the *EMC
9 common command requires one parameter, so receiving *EMC is not allowed.

- Header separator error

1
1 A character which is not a legal header separator was encountered while parsing the
1 header. For example, no white space followed the header, thus *GMC"MACRO" is in
1 error.

- Program mnemonic too long

1
1 The header contains more than twelve characters (see IEEE 488.2, 7.6.1.4.1).
2

- Undefined header

1 The header is syntactically correct, but it is undefined for this specific device. For
1 example, *XYZ is not defined for any device.
3

- Invalid character in number

1 An invalid character for the data type being parsed was encountered. For example, an
2 alpha in a decimal numeric or a "9" in octal data.
1

- Exponent too large

1 The magnitude of the exponent was larger than 32000 (see IEEE 488.2, 7.7.2.4.1).
2
3

- Too many digits

1 The mantissa of a decimal numeric data element contained more than 255 digits
2 excluding leader zeros (see IEEE 488.2, 7.7.2.4.1).
4

- Numeric data not allowed

1
2
8

- A legal numeric data element was received, but the device does not accept one in this
1 position for the header.

3 Invalid suffix
1

The suffix does not follow the syntax described in IEEE 488.2, 7.7.3.2, or the suffix is
inappropriate for this device.

- Suffix too long

1 The suffix contained more than 12 characters (see IEEE 488.2, 7.7.3.4).
3
4

- Invalid character data

1 Either the character data element contains an invalid character or the particular
4 element received is not valid for the header.
1

- Character data too long

1 The character data element contains more than twelve characters (see IEEE 488.2,
4 7.7.1.4).
4

- Character data not allowed

1
4 A legal character data element was encountered where prohibited by the device.
8

- String data not allowed

1
5 A string data element was encountered but was not allowed by the device at this point in
8 parsing.

- Block data not allowed

1
6 A legal block data element was encountered but was not allowed by the device at this
8 point in parsing.

- Expression data not allowed

1
7 A legal expression data was encountered but was not allowed by the device at this point
8 in parsing.

GPIB Execution Errors

- Settings Conflict

2
2 Indicates that a legal program data element was parsed but could not be executed due to
1 the current device state (see IEEE 488.2, 6.4.5.3 and 11.5.1.1.5).

- Data out of range

2
2 Indicates that a legal program data element was parsed but could not be executed
2 because the interpreted value was outside the legal range as defined by the device (see
2 IEEE 488.2, 11.5.1.1.5).

- Illegal parameter Value

2
2 Indicates that a parameter is not correct. Check to make sure that the GPIB commands
4 are correctly spelled.

- Hardware Missing pulse Mod not allowed -- no hardware

2
4 Indicates that the 8648B/C is not fitted with the pulse modulator (Option 1E6).
1

GPIB Device-Specific Errors

- Self-test failed

3
3
0

- Queue overflow

3
5
0 A specific code entered into the queue in lieu of the code that caused the error. This code indicates that there is no room in the queue and an error occurred but was not recorded.

GPIB Query Errors

- Query UNTERMINATED

4
2
0 Indicates that a condition causing an UNTERMINATED Query error occurred (see IEEE 488.2, 6.3.2.2). For example, the device was addressed to talk and an incomplete program message was received.

- Query DEADLOCKED

4
3
0 Indicates that a condition causing a DEADLOCKED Query error occurred (see IEEE 488.2, 6.3.1.7). For example, both input buffer and output buffer are full and the device cannot continue.

- Query UNTERMINATED after indefinite response

4
4
0 Indicates that a query was received in the same program message after a query requesting an indefinite response was executed (see IEEE 488.2, 6.5.7.5).

Five second self test...

This message appears when the command `*tst?` is sent to the instrument over the GPIB bus. The instrument runs a subset of its power-up tests when this message is displayed. The local key is disabled during this time.

Service Messages

Messages numbered 500 and above relate to the service self test provided within the instrument. For information about troubleshooting the instrument, refer to Chapter 5, “Service”.

Operation messages
Service Messages

GPIB Programming

Background

This signal generator adheres to the IEEE 488.1-1987, IEEE 488.2-1987, and SCPI Version 1992.0 command language.

In 1987, the IEEE released IEEE 488.2-1987, Codes, Formats, Protocols and Common Commands for Use with IEEE 488.1-1987. This standard defined the roles of instruments and controllers in a measurement system and a structured scheme for communication. In particular, IEEE 488.2 described how to send commands to instruments and how to send responses to controllers. It defined some frequently used housekeeping commands explicitly, but each instrument manufacturer was left with the task of naming any other types of commands and defining their effect. IEEE 488.2 specified how certain types of features should be implemented if they were included in an instrument. It generally did not specify which features or commands should be implemented for a particular instrument. Thus, it was possible that two similar instruments could each conform to IEEE 488.2, yet they could have an entirely different command set.

Standard Commands for Programmable Instruments (SCPI) is the new instrument command language for controlling instruments that goes beyond IEEE 488.2 to address a wide variety of instrument functions in a standard manner. SCPI promotes consistency, from the remote programming standpoint, between instruments of the same class and between instruments with the same functional capability.

Programming Guidelines

GPIB Definition GPIB, the General Purpose Interface Bus, is the instrument-to-instrument communication system between the signal generator and up to 14 other instruments. Any instrument having GPIB capability can be interfaced to the signal generator, including non-Agilent instruments that have “GPIB”, “IEEE-488”, “ANSI MC1.1”, or “IEC-625” capability (these are common generic terms for GPIB; all are electrically equivalent although IEC-625 uses a unique connector).

What is Programmable All functions are programmable except the front panel power key, knobs, increment set key, arrow keys, frequency reference keys and the rear panel display contrast control.

GPIB Address The GPIB address for the signal generator is set to 19 at the factory. It may be changed to any address from 00 through 30 by pressing **ADRS** and the desired two-digit number.

Error Messages The GPIB programming error messages are described in Chapter 1c, “Operation Messages.”

Programming Language Although many system controllers and programming software languages are compatible with this instrument, all examples and references in this manual assume the use of a controller utilizing the HP BASIC programming language.

Query Most instrument settings may be queried via GPIB. The data returned from the query will vary from a yes/no (1/0) to the actual setting, depending on the function. See Table 2-1.

Advanced Programming For the majority of applications, remotely programming the signal generator requires only basic programming knowledge and the command statements listed later in this chapter. Developing programs for querying the instrument’s status is considered to be an advanced application. (See “GPIB Status Reporting.”)

Programming Examples

Examples are provided here to help you understand the required programming structure. All examples use the HP BASIC programming language. See Table 2-1 for a complete listing of commands.

Note

Command statements may be concatenated on the same line if separated by a semicolon. A colon must precede successive command statements to ensure command hierarchy.

Programming RF Frequency

```
OUTPUT 719; "FREQ: CW 500 MHZ"
```

OUTPUT	The output statement (HP BASIC) tells the system controller to output what follows.
7	The Input/Output select code of the system controller is 7.
19	The GPIB address of the signal generator is 19.
Semicolon (;)	A semicolon separates the HP BASIC command from the output string that follows.
Quotes (" ")	All command statements must be contained in quotes.
FREQ: CW	This command programs the RF frequency. FREQ must be in the statement first representing its hierarchy over :CW. The colon (:) is used to separate the command hierarchy. The signal generator will be programmed to a RF frequency of 500 MHz.

Programming RF Frequency and FM Modulation

```
OUTPUT 719; "FREQ: CW 500 MHZ; :FM: DEV 3 KHZ; :FM: SOUR  
EXT; :FM: EXT: COUP AC; :AM: STAT OFF; :PM: STAT OFF; :FM: STAT  
ON"
```

FM: DEV	This command programs the FM deviation. FM is higher than DEV in the command hierarchy and is separated by a colon (:). The signal generator will be programmed to 3 kHz of deviation.
Semicolon (;)	A semicolon separates completed command statements.
FM: SOUR: EXT	This command selects the external path for the modulation source.
FM: EXT: COUP AC	This command selects ac coupling.
FM: STAT ON	This command changes the FM modulation to an on state. A modulation format must be turned on before it is active. The other two modulation formats must be turned off prior to activating the desired modulation (AM: STAT OFF and PM: STAT OFF).

Querying RF Frequency

```
100 OUTPUT 719; "FREQ: CW?"  
200 ENTER 719; Freq_set  
300 PRINT "Frequency is"; Freq_set; "Hz"
```

- Line 100 This command outputs a query for the RF frequency setting. You may attach a question mark (?) to any of the signal generators' commands to query its setting.
- Line 200 This command enters the queried frequency setting into the variable Freq_set
- Line 300 This command prints the queried frequency setting.

Programming RF Amplitude

```
OUTPUT 719; "POW: AMPL -47 DBM; :OUTP: STAT ON"
```

POW:AMPL -47 DBM This command programs the RF amplitude. POW is higher than AMPL in the command hierarchy and is separated by a colon. The signal generator's RF amplitude will be programmed to -47 dBm.

OUTP:STAT ON This command changes the RF amplitude to an on state. The RF amplitude defaults to an off state when the instrument is powered on.

Programming Pulse Modulation (Option 1E6)

```
OUTPUT 719; "PULM: STAT ON" "PULM: STAT OFF"
```

PULM:STAT ON This command enables the pulse modulator which must be driven from the rear panel input.

PULM:STAT OFF This command disables the pulse modulator.

Programming Pager Encoder (Option 1EP)

```
100 OUTPUT 719; "FREQ: CW 159.5MHZ"  
200 OUTPUT 719; "POW: AMPL 0DEM; :OUTP: STAT ON"  
300 OUTPUT 719; "PAG: SEL FLEX"  
400 OUTPUT 719; "DM: FORM FSK2; DEV 4.8KHZ; STAT ON"  
500 OUTPUT 719; "PAG: FLEX: RATE 1600"  
600 OUTPUT 719; "PAG: FLEX: TYPE NUM; MESS: SEL 1"  
700 OUTPUT 719; "PAG: FLEX: CODE 'A0000001'"  
800 OUTPUT 719; "TRIG: COUN 1"  
900 OUTPUT 719; "INIT: IMM"
```

Line 100	Programs the RF frequency.
Line 200	Programs the RF amplitude, and sets the output on.
Line 300	Programs the pager format.
Line 400	Programs the modulation and deviation, and sets the modulation on.
Line 500	Programs the data rate and modulation.
Line 600	Programs the pager type and message to be sent.
Line 700	Programs the pager capcode (address.)
Line 800	Programs how many times the pager signal will be transmitted.
Line 900	Starts encoding.

Table 2-1. Programming Command Statements and Descriptions

Command Statement	Description	Query
Amplitude		
OUTP:STAT ON	Turns the RF output on	OUTP:STAT?
OUTP:STAT OFF	Turns the RF output off	
POW:AMPL <value> <units>	Sets the amplitude of the RF output to the desired <value> and <units>. <value> may be up to 4 digits plus a sign if applicable, e.g. -127.1 or maximum resolution of .1 dB, .001 mV, .01 μ V. <units> may be DBM, MV, UV, MVEMF, UVEMF, DBUV, DBUVEMF. If in reference mode only DB or DBM are allowed.	POW:AMPL?
POW:ATT:AUTO ON	Turns automatic attenuator control on (normal setting).	POW:ATT:AUTO?
POW:ATT:AUTO OFF	Turns automatic attenuator control off and holds present attenuator setting.	
POW:REF <value> <units>	Sets a reference to the <value> in <units> as described in setting amplitude. Reference state must be on, to be active.	POW:REF?
POW:REF:STAT ON	Sets reference to on, making all amplitude changes relative to the reference.	POW:REF:STAT?
POW:REF:STAT OFF	Sets reference to off, making all amplitude changes absolute.	
Frequency		
FREQ:CW <value> <units>	Sets the RF frequency to the <value> and <units>. <value> may be up to 9 digits with a maximum of 10 Hz resolution. <units> may be MHZ, KHZ or HZ.	FREQ:CW?
FREQ:REF <value> <units>	Sets a reference to the <value> in <units> as described in setting frequency. Reference state must be on, to be active.	FREQ:REF?
FREQ:REF:STAT ON	Sets reference to on, making all frequency changes relative to the reference.	FREQ:REF:STAT?
FREQ:REF:STAT OFF	Sets reference to off, making all frequency changes absolute.	
Modulation		
Amplitude Modulation		
AM:DEPT <value> PCT	Sets AM depth in %, <value> from 0.1 to 99.9.	AM:DEPT?
AM:STAT ON	Sets AM on, FM and PM must have state off.	AM:STAT?
AM:STAT OFF	Sets AM off.	
AM:SOUR INT	Selects internal source.	AM:SOUR?
AM:SOUR INT2	Selects internal source 2 for AM. (Options 1E2 & 1EP only)	
AM:SOUR EXT	Selects external source.	
AM:SOUR INT,EXT	Selects internal and external sources.	
AM:INT:FREQ 1 KHZ	Selects internal 1 kHz frequency.	AM:INT:FREQ?
AM:INT:FREQ 400 HZ	Selects internal 400 Hz frequency.	
AM:INT2:FREQ <value> <units>	Sets the internal modulation generator (1E2) or the internal audio generator (1EP) frequency to the <value> and <units>. (Options 1E2 & 1EP only)	AM:INT2:FREQ?
AM:INT2:FUNC:SHAP <shape>	Sets the internal modulation generator waveform to the <shape>. <shape> may be SIN, TRI, SQU, or SAW. (Options 1E2 & 1EP only)	AM:INT2:FUNC:SHAP?
AM:EXT:COUP DC	Selects external dc coupling for AM.	AM:EXT:COUP?
AM:EXT:COUP AC	Selects external ac coupling for AM.	

Table 2-1. Programming Command Statements and Descriptions (continued)

Command Statement	Description	Query
Modulation (continued)		
Frequency Modulation		
CAL:DCFM	Eliminates dc FM offset	
FM:DEV <value> KHZ	Set FM deviation in kHz, <value> from 0.00 to 9.99 and 10.0 to 99.9, <value> may also be entered in Hz (HZ).	FM:DEV?
FM:STAT ON	Sets FM on, AM and PM must have state off.	FM:STAT?
FM:STAT OFF	Sets FM off.	
FM:SOUR INT	Selects internal source for FM.	FM:SOUR?
FM:SOUR INT2	Selects internal source 2 for FM. (Options 1E2 & 1EP only)	
FM:SOUR EXT	Selects external source for FM.	
FM:SOUR INT,EXT	Selects internal and external sources.	
FM:INT:FREQ 1 KHZ	Selects internal 1 kHz frequency.	FM:INT:FREQ?
FM:INT:FREQ 400 HZ	Selects internal 400 Hz frequency.	
FM:INT2:FREQ <value> <units>	Sets the internal modulation generator (1E2) or the internal audio generator (1EP) frequency to the <value> and <units>. (Options 1E2 & 1EP only)	FM:INT2:FREQ?
FM:INT2:FUNC:SHAP <shape>	Sets the internal modulation generator waveform to the <shape>. <shape> may be SIN, TRI, SQU, or SAW. (Options 1E2 & 1EP only)	FM:INT2:FUNC:SHAP?
FM:EXT:COUP DC	Selects external dc coupling for FM.	FM:EXT:COUP?
FM:EXT:COUP AC	Selects external ac coupling for FM.	
Phase Modulation		
PM:DEV <value> RAD	Sets phase modulation in radians (RAD), <value> from 0.00 to 9.99 and 10.0.	PM:DEV?
PM:STAT ON	Sets PM on. AM and FM must have state off.	PM:STAT?
PM:STAT OFF	Sets PM off.	
PM:SOUR INT	Selects internal source for PM.	PM:SOUR?
PM:SOUR INT2	Selects internal source 2 for PM. (Options 1E2 & 1EP only)	
PM:SOUR EXT	Selects external source for PM.	
PM:SOUR INT,EXT	Selects internal and external sources.	
PM:INT:FREQ 1 KHZ	Selects internal 1 kHz frequency.	PM:INT:FREQ?
PM:INT:FREQ 400 HZ	Selects internal 400 Hz frequency.	
PM:INT2:FREQ <value> <units>	Sets the internal modulation generator (1E2) or the internal audio generator (1EP) frequency to the <value> and <units>. (Options 1E2 & 1EP only)	PM:INT2:FREQ?
PM:INT2:FUNC:SHAP <shape>	Sets the internal modulation generator waveform to the <shape>. <shape> may be SIN, TRI, SQU, or SAW. (Options 1E2 & 1EP only)	PM:INT2:FUNC:SHAP?
PM:EXT:COUP DC	Selects external dc coupling for PM.	PM:EXT:COUP?
PM:EXT:COUP AC	Selects external ac coupling for PM.	
Pulse Modulation (Option 1E6)		
PULM:STAT ON	Switches pulse modulation on.	PULM:STAT ON?
PULM:STAT OFF	Switches pulse modulation off.	PULM:STAT OFF?

Table 2-1. Programming Command Statements and Descriptions (continued)

Command Statement	Description	Query
Modulation (continued)		
Pager Encoding (Option 1EP)		
INIT:IMM	Starts encoding.	
ABOR	Stops encoding.	
TRIG:COUN <value>	Sets the number of transmissions. Count 1 and collapse cycle 0 represent single mode. Counts 0 to 255 represent burst mode. Count 0 represents continuous mode.	TRIG:COUN?
DM:FORM FSK2 FSK4	Sets DM modulation to FSK2 or FSK4.	DM:FORM?
DM:STAT ON OFF	Sets DM modulation on or off.	DM:STAT?
DM:DEV <value>	Sets DM modulation deviation.	DM:DEV?
DM:POL NORM INV	Sets DM modulation polarity to normal or inverse.	DM:POL?
DM:FILT:STAT ON OFF	Sets DM modulation filter on or off.	DM:FILT:STAT?
PAG:SEL POCS FLEX FTD RESY PN15	Sets the pager format to POCSAG, FLEX, FLEX-TD, RESYNC, or PN15.	PAG:SEL?
PAG:{POCS FLEX FTD PN15}:RATE <value>	Sets the data rate for the specified pager format.	PAG:{POCS FLEX FTD PN15}:RATE?
PAG:{POCS FLEX FTD}:MESS:SEL <value>	Selects the message to be encoded.	PAG:{POCS FLEX FTD}:MESS:SEL?
PAG:{POCS FLEX FTD}:MESS:DEF 'string'	Sets the user definable message.	PAG:{POCS FLEX FTD}:MESS:DEF?
PAG:{POCS FLEX FTD}:MESS:LENG <value>	Sets the message length.	PAG:{POCS FLEX FTD}:MESS:LENG?
PAG:{POCS FLEX FTD}:ARB:DEF <value>,...,<value>	Sets the arbitrary message.	
PAG:{POCS FLEX FTD}:ARB:STAR <value>	Sets the start frame (FLEX/FLEX-TD) or start batch (POCSAG).	PAG:{POCS FLEX FTD}:ARB:STAR?
PAG:{POCS FLEX FTD}:ARB:STOP <value>	Sets the stop frame (FLEX/FLEX-TD) or stop batch (POCSAG).	PAG:{POCS FLEX FTD}:ARB:STOP?
PAG:{FLEX FTD}:TYPE	Sets the type of message to be sent.	PAG:{FLEX FTD}:TYPE?
TONE NUM ALPH HBIN		
PAG:{FLEX FTD}:VECT STAN SPEC NUMB	Sets the type of numeric message.	PAG:{FLEX FTD}:VECT?
PAG:{FLEX FTD}:NUMB <value>	Sets the number of numeric vectors to be sent.	PAG:{FLEX FTD}:NUMB?
PAG:{FLEX FTD}:CYCL <value>	Sets the cycle number for FLEX/FLEX-TD.	PAG:{FLEX FTD}:CYCL?
PAG:{FLEX FTD}:FRAM <value>	Sets the frame number for FLEX/FLEX-TD.	PAG:{FLEX FTD}:FRAM?
	Returns the current cycle number during encoding.	PAG:{FLEX FTD}:CCOunt?
	Returns the current frame number during encoding.	PAG:{FLEX FTD}:FCOunt?
PAG:{FLEX FTD}:PHAS A B C D	Sets the phase for FLEX/FLEX-TD.	PAG:{FLEX FTD}:PHAS?
PAG:{FLEX FTD}:COLL <value>	Sets the collapse cycle for FLEX/FLEX-TD.	PAG:{FLEX FTD}:COLL?
PAG:{FLEX FTD}:CODE 'string'	Sets the pager code for FLEX/FLEX-TD format. The frame, phase, collapse cycle, and short/long address are automatically determined.	PAG:{FLEX FTD}:CODE?

Table 2-1. Programming Command Statements and Descriptions (continued)

Command Statement	Description	Query
PAG:{FLEX FTD}:ATYP SHOR LONG	Sets the address type to short or long.	PAG:{FLEX FTD}:ATYP?
PAG:{FLEX FTD}:ADDR{1 2} <value>	Sets the address 1 and 2.	PAG:{FLEX FTD}:ADDR{1 2}?
PAG:{FLEX FTD}:IST:STAT ON OFF	Sets the instrument behavior when a stop event occurs.	PAG:{FLEX FTD}:IST:STAT?
PAG:{FLEX FTD}:HEAD:STAT ON OFF	Sets the header for FLEX/FLEX-TD on or off.	PAG:{FLEX FTD}:HEAD:STAT?
PAG:{FLEX FTD}:TERM:STAT ON OFF	Sets the terminator for FLEX/FLEX-TD on or off.	PAG:{FLEX FTD}:TERM:STAT?
PAG:{FLEX FTD}:VECT STAN SPEC NUMB	Sets the type of numeric message.	PAG:{FLEX FTD}:VECT?
PAG:{FLEX FTD}:HBIN BIT1 BIT7 BIT8 BIT14 BIT16	Sets the bits per character of HEX/Binary message.	PAG:{FLEX FTD}:HBIN?
PAG:{FLEX FTD}:DCAL:STAT ON OFF	Sets the dummy call on or off.	PAG:{FLEX FTD}:DCAL:STAT?
PAG:{FLEX FTD}:DCAL:ADDR{1 2} <value>	Sets the dummy call address 1 and 2.	PAG:{FLEX FTD}:DCAL:ADDR{1 2}?
PAG:{FLEX FTD}:ROAM:SEL NONE SSID NID	Selects the roaming mode.	PAG:{FLEX FTD}:ROAM:SEL?
PAG:{FLEX FTD}:ROAM:SSID:LID <value>	Sets the SSID local ID of the pager.	PAG:{FLEX FTD}:ROAM:SSID:LID?
PAG:{FLEX FTD}:ROAM:SSID:CZON <value>	Sets the SSID coverage zone of the pager.	PAG:{FLEX FTD}:ROAM:SSID:CZON?
PAG:{FLEX FTD}:ROAM:SSID:CCOD <value>	Sets the SSID country code of the pager.	PAG:{FLEX FTD}:ROAM:SSID:CCOD?
PAG:{FLEX FTD}:ROAM:SSID:TMF <value>	Sets the SSID traffic management flag.	PAG:{FLEX FTD}:ROAM:SSID:TMF?
PAG:{FLEX FTD}:ROAM:SSID:FOFF <value>	Sets the SSID frame offset.	PAG:{FLEX FTD}:ROAM:SSID:FOFF?
PAG:{FLEX FTD}:ROAM:NID:ADDR <value>	Sets the NID address.	PAG:{FLEX FTD}:ROAM:NID:ADDR?
PAG:{FLEX FTD}:ROAM:NID:CHAN <value>	Sets each RF channel of the NID roaming.	PAG:{FLEX FTD}:ROAM:NID:CHAN?
PAG:{FLEX FTD}:ROAM:NID:AREA <value>	Sets the NID area code.	PAG:{FLEX FTD}:ROAM:NID:AREA?
PAG:{FLEX FTD}:ROAM:NID:MULT <value>	Sets the extension of Network Address.	PAG:{FLEX FTD}:ROAM:NID:MULT?
PAG:{FLEX FTD}:ROAM:NID:TMF <value>	Sets the NID traffic management flag.	PAG:{FLEX FTD}:ROAM:NID:TMF?
PAG:{FLEX FTD}:ROAM:NID:FOFF <value>	Sets the NID frame offset.	PAG:{FLEX FTD}:ROAM:NID:FOFF?
PAG:FTD:REP <value>	Sets the number of repeats for FLEX- TD.	PAG:FTD:REP?
	Returns the current number of repeats during encoding.	PAG:FTD:RCO?
PAG:POCS:TYPE TONE NUM ALPH ALPH7 ALPH8	Sets the message type to be sent.	PAG:POCS:TYPE?
PAG:POCS:CODE <value>	Sets the pager code for POCSAG format.	PAG:POCS:CODE?
PAG:POCS:FUNC 0 1 2 3	Sets the POCSAG function bit.	PAG:POCS:FUNC?

Table 2-1. Programming Command Statements and Descriptions (continued)

Command Statement	Description	Query
Standard Commands for Status (See also “GPIB Status Reporting” examples)		
STAT:QUES:POW:ENAB <NR1>	Returns contents of the power condition register. Enables <NR1> event registers for power.	STAT:QUES:POW:COND? STAT:QUES:POW:ENAB?
STAT:QUES:POW:EVEN?	Returns contents of enabled event registers for power.	STAT:QUES:POW:EVEN?
STAT:QUES:MOD:ENAB <NR1>	Returns contents of the modulation condition register. Enables <NR1> event registers for modulation.	STAT:QUES:MOD:COND? STAT:QUES:MOD:ENAB?
STAT:QUES:MOD:EVEN?	Returns contents of enabled registers for modulation.	STAT:QUES:MOD:EVEN?
STAT:QUES:CAL:FEXT:ENAB <NR1>	Returns contents of enabled registers for frequency extension calibration. Returns contents of the frequency extension calibration condition register.	STAT:QUES:CAL:FEXT[:EVEN?] STAT:QUES:CAL:FEXT:COND?
STAT:QUES:CAL:FEXT:EVEN?	Returns contents of enabled event registers for frequency extension calibration.	STAT:QUES:CAL:FEXT:ENAB?
STAT:QUES:PAG:ENAB <NR1>	Returns contents of the pager encoding condition register. (Option 1EP) Enables <NR1> event registers for pager encoding. (Option 1EP)	STAT:QUES:PAG:COND? STAT:QUES:PAG:ENAB?
STAT:QUES:PAG:EVEN?	Returns contents of enabled event registers for pager encoding. (Option 1EP)	STAT:QUES:PAG:EVEN?
System		
SYST:LANG “COMP” “SCPI”	Sets the signal generator to 8656/57-compatible or SCPI language. Returns any system error message. Returns a formatted numeric value corresponding to the SCPI version number for which the instrument complies.	SYST:ERR? SYST:VERS?

Table 2-1. Programming Command Statements and Descriptions (continued)

Command Statement	Description	Query
IEEE 488.2 Common Commands		
*RST	Resets the signal generator to a default state (see SCPI Command Reference). Returns the instruments identity. Executes an instrument self-test.	*IDN? *TST?
*WAI	Instrument waits until previous commands are completed.	
*CLS	Clears status and event registers.	
*ESE <dec. num. data>	Enables Standard Event Status Register bits. Queries the Standard Event Status Enable Register.	*ESE?
*OPC	Queries the Standard Event Status Register. Enables the Operation Complete bit of the Standard Event Status Register. Queries the Operation Complete bit of the Standard Event Register.	*ESR? *OPC?
*RCL <reg_num>[,<seq_num>]	Recalls the Standard Event Status Register. <seq_num> is optional in that the last sequence number that was sent over GPIB is stored and that number is used if no sequence number is used in the command. The power-up default sequence number is 0.	
*SAV <reg_num>[,<seq_num>]	Saves the Standard Event Status Register. <seq_num> is optional in that the last sequence number that was sent over GPIB is stored and that number is used if no sequence number is used in the command. The power-up default sequence number is 0.	
*SRE <dec. num. data>	Enables the bits in the Status Byte that will cause a Service Request. Queries the Service Request Enable Register. Queries the Status Byte with the MSS bit.	*SRE? *STB?

GPIB Status Reporting

The IEEE 488.2 standard provides a status byte for instrument status reporting. This status byte may be accessed by using IEEE 488.2 Common Commands and SCPI Status Commands. The following figure shows the status reporting structure for instrument operation.

The following examples will be used to explain instrument operation status:

- External Modulation Input Status
- Reverse Power Protection Status
- Unspecified Power (Amplitude) Entry Status
- Pager Encoding Complete Status

General IEEE 488.2 status reporting will not be covered. The above operating status will satisfy most needs for status reporting.

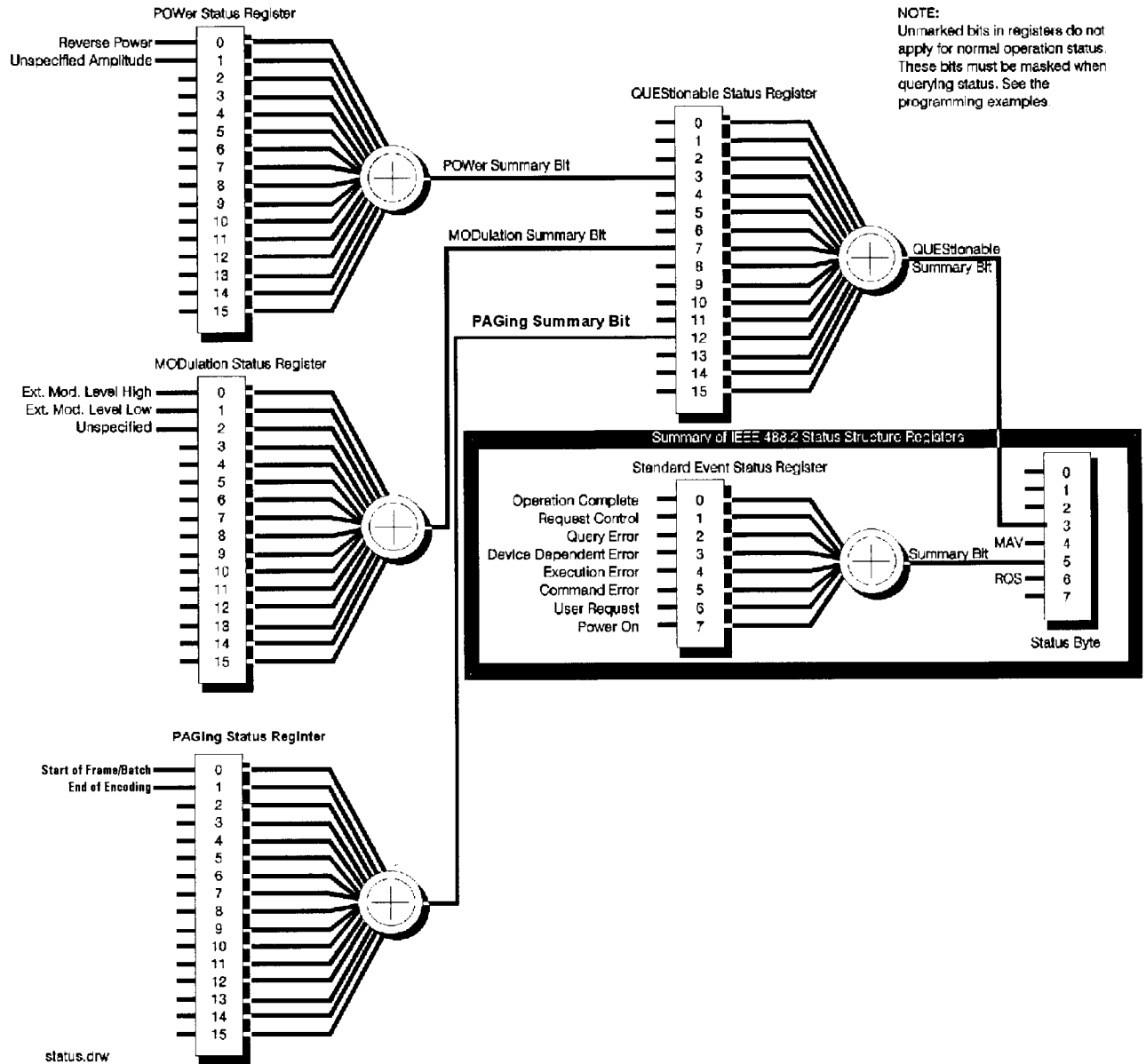

Figure 2-1. 8648 Status Register Model

External Modulation Input Level Status

External modulation input level status may be queried for high, low, or input level correct. The instrument automatically detects the input level (1 Vpk into 600 ohms for full scale modulation) and displays the result on the front panel display but must be queried for GPIB reporting.

Example: Check the Condition of Modulation Input (High or Low)

```
10 OUTPUT 719; "STAT:QUES:MOD:COND?"
20 ENTER 719; Value
30 Mod=BINAND(Value,1)
40 IF Mod=1 THEN PRINT "Ext.Mod.Input High"
50 Mod=BINAND(Value,2)
60 IF Mod=2 THEN PRINT "Ext.Mod.Input Low"
70 END
```

- Line 10 Queries the condition of the MODulation register. Besides querying the condition you may also query if an event has occurred, such as the external modulation input being high or low at some previous time. Replace the COND? with EVEN? to read the event status. Reading the event status clears the register.
- Line 20 Enters the condition of the MODulation register into the variable "Value".
- Line 30 Uses the HP BASIC command, BINAND to check the contents of bit 0 in "Value". If bit 0 is a "1" it will be reported as a decimal equivalent "1" and "Mod" will equal "1".
- Line 40 Checks if the MODulation condition is "1" and if true, prints that the external modulation input is high.
- Line 50 Uses the HP BASIC command, BINAND to check the contents of bit 1 in "Value". If bit 1 (decimal equivalent "2") is a "1", "Mod" will equal "1".
- Line 60 Checks if the MODulation condition is "2" and if true, prints that the external modulation input is low.

Example: Generate a Service Request for External Modulation

Input (High& or Low)

```
10 OUTPUT 719; "STAT:QUES:MOD:ENAB 3"  
20 OUTPUT 719; "STAT:QUES:ENAB 128"  
30 OUTPUT 719; "*SRE 8"  
40 IF SPOLL(719) THEN PRINT "Ext. Mod. Input High/Low  
Detected"  
50 OUTPUT 719; "*CLS"  
60 END
```

- | | |
|---------|---|
| Line 10 | Enables bits 0 and 1 (decimal equivalent 3) in the MODulation register. Enabling these bits masks other bits in the MODulation register from reporting their status in the summary bit to QUEStionable. |
| Line 20 | Enables bit 7 (decimal equivalent 128) in the QUEStionable register. Enabling this bit masks other bits in the QUEStionable register from reporting their status in the summary bit to STATus. |
| Line 30 | Enables bit 3 (decimal equivalent 8) of the STATus register. Enabling this bit masks other bits from reporting. |
| Line 40 | Uses the HP BASIC command, SPOLL, (Serial Poll) to see if the service request bit is reporting any interrupts. |
| Line 50 | Clears all status registers. Clearing the status registers is not absolutely necessary, but is used here because of the unknown state of the instrument. |

Reverse Power Protection Status

This instrument provides protection from signals inadvertently applied to the RF output of the instrument. This protection is commonly called reverse power protection (RPP). The instrument automatically detects the reverse power, which in-turn disconnects the instrument's RF output. When the RPP engages, the front panel display will read RF OFF but must be queried for GPIB reporting.

Example: Check the condition of the RPP

```
10 OUTPUT 719; "STAT:QUES:POW:COND?"
20 ENTER 719; Value
30 Rpp=BINAND(Value,1)
40 IF Rpp=1 THEN PRINT "RPP is engaged"
50 IF Rpp=1 THEN INPUT "Is reverse power input
corrected(Y/N)",R#
60 IF R#="Y"THEN OUTPUT719;"OUTP:STAT ON"
70 END
```

Line 10	Queries the condition of the POWER register.
Line 20	Enters the condition of the POWER register into the variable "Value".
Line 30	Uses the HP BASIC command, BINAND to check the contents of bit 0 in "Value". If bit 0 is a "1", "Rpp" will equal "1".
Line 40	Checks if the RPP condition is "1" and if true prints that the RPP is engaged.
Line 50	Checks if RPP condition is "1" and if true asks if the situation has been corrected.
Line 60	Checks if the answer was yes to correction and if true turns the RF output on to reset the RPP.

Unspecified Power (Amplitude) Entry Status

This instrument provides a message if an amplitude entry is requested above +10 dBm and less than or equal to +13 dBm or if an attenuator hold range is exceeded (see operating part of manual). When an unspecified amplitude is entered, the front panel display will read "Amplitude exceeds specified range", but must be queried for GPIB reporting.

Example: Check the Condition of Unspecified Power Entry

```
10 OUTPUT 719; "STAT:QUES:POW:COND?"
10 ENTER 719:Value
30 Pow_spec=BINAND(Value,2)
40 IF Pow_spec=2 THEN PRINT "Amplitude unspecified"
50 END
```

- Line 10 Queries the condition of the POWER register. Besides querying the condition you may also query if an event has occurred. Replace the COND? with EVEN? to read the event status. Reading the event status clears the register.
- Line 20 Enters the condition of the POWER register into the variable "Value".
- Line 30 Uses the HP BASIC command, BINAND to check the contents of bit 1 in "Value". If bit 1 is "high", Pow_spec will equal "2".
- Line 40 Checks if Pow_spec equals 2 and then prints that the amplitude is in an unspecified range.

Pager Encoding Status (Option 1EP Only)

Paging encoding status may be queried to detect the end of encoding, or the start of each frame (for FLEX/FLEX-TD) or batch (for POCSAG). Figure 2-2 shows the example of the outputs of these bits for the following settings.

Format FLEX
 Output Mode Burst
 No. of Bursts 4
 Start Frame 0
 Collapse Cycle 0
 Header On
 Terminator On

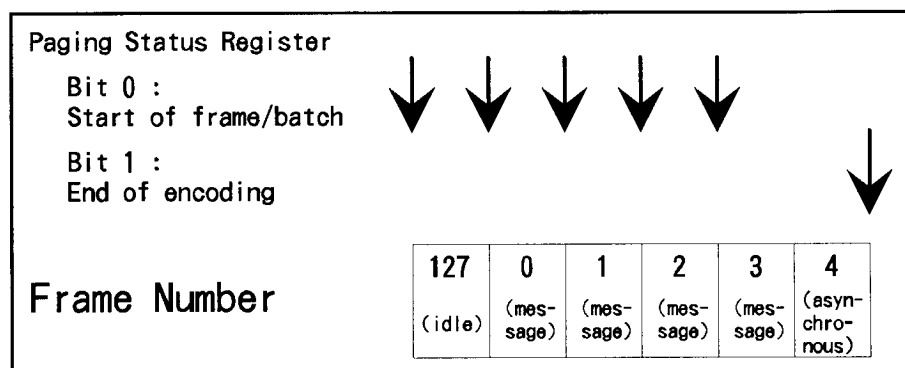

Figure 2-2. Paging Encoding Status

Note

If the pager format is POCSAG and the message extends over two batches, the start of each frame/batch bit is set at every two batches.

Example: Check the end of message encoding

```
10 OUTPUT 719; "STAT:QUES:PAG:ENAB 2"
20 OUTPUT 719; "STAT:QUES:ENAB 4096"
30 OUTPUT 719; "*SRE 8"
40 IF SPOLL(719) THEN PRINT "Encoding complete."
50 OUTPUT 719; "*CLS"
60 END
```

- Line 10 Enables bit 1 (decimal equivalent 2) in the PAGing register. Enabling this bit masks other bits in the PAGing register from reporting their status in the summary bit to QUEStionable.
- Line 20 Enables bit 12 (decimal equivalent 4096) in the QUEStionable register. Enabling this bit masks other bits in the QUEStionable register from reporting their status in the summary bit to STATus.
- Line 30 Enables bit 3 (decimal equivalent 8) of the STATus register. Enabling this bit masks other bits from reporting.
- Line 40 Uses the HP BASIC command, SPOLL, (Serial Poll) to see if the service request bit is reporting any interrupts.

Line 50 Clears all status registers. Clearing the status registers is not absolutely necessary, but is used here because of the unknown state of the instrument.

Example: Check the start of each frame

```
10 OUTPUT 719; "STAT:QUES:PAG:ENAB 1"  
20 OUTPUT 719; "STAT:QUES:ENAB 4096"  
30 OUTPUT 719; "*SRE 8"  
40 IF SPOLL(719) THEN PRINT "Encoding complete."  
50 OUTPUT 719; "*CLS"  
60 END
```

Line 10 Enables bit 0 (decimal equivalent 1) in the PAGing register. Enabling this bit masks other bits in the PAGing register from reporting their status in the summary bit to QUEStionable.

Line 20 Enables bit 12 (decimal equivalent 4096) in the QUEStionable register. Enabling this bit masks other bits in the QUEStionable register from reporting their status in the summary bit to STATus.

Line 30 Enables bit 3 (decimal equivalent 8) of the STATus register. Enabling this bit masks other bits from reporting.

Line 40 Uses the HP BASIC command, SPOLL, (Serial Poll) to see if the service request bit is reporting any interrupts.

Line 50 Clears all status registers. Clearing the status registers is not absolutely necessary, but is used here because of the unknown state of the instrument.

SCPI Command Reference

Table 2-2. Dictionary of Terms

Terms	Description
<NRf>	Indicates an ASCII representation of a number if required in the command statement. The numbers may be an integer or floating- point, and may include a decimal exponent. (NRf stands for “flexible numeric representation.” For further information, refer to the IEEE 488.2 standard.)
<NR1>	Indicates an ASCII representation of a number if required in the command statement. The number must be an integer and may not include decimal points. For further information, refer to the IEEE 488.2 standard.)
<AM term>	Indicates that a “PCT” termination is required in the command statement. If no termination is specified, a “PCT” value is assumed.
<freq term>	Indicates that a “HZ”, “KHZ”, “GHZ”, or “MHZ” termination is required in the command statement. IF the command is not terminated then “HZ” is assumed.
<angle term>	Indicates that a “RAD” termination is required in the command statement. If no termination is specified then “RAD” is assumed.
<ampl term>	Indicates that a “DB”, “DBM”, “DBUV”, “UV”, “MV”, “V”, “UVEMF”, “MVEMF”, or “DBUVEMF” termination is required in the command statement. If no termination is specified then “DBM” is assumed.
[command]	Bracketed commands are optional. SCPI assumes the optional command is present.
param param	Parameters separated by “ ” indicate that either parameter is acceptable.
param,param	Parameters separated by “,” indicate that multiple parameters are allowed.
{command command}	Commands enclosed in the {} blanket indicate one of these codes can be selected.
'string'	Indicates a string parameter that contains ASCII character. A string must begin with a double quote (") and end with a double quote mark. You can include the quotation marks as part of the string by typing it twice without any characters in between the quotation marks. Or, you can avoid typing the quotation marks twice by using a single quotation mark(').

ABORt Subsystem (Option 1EP Only)

ABORt

This command stops pager encoding.

Note

Pager encoder programming commands are valid only for instruments with Option 1EP.

AM Subsystem

[SOURce]

:AM

[:DEPTh]?

[:DEPTh] <NRf> [<AM term>]

Sets AM Depth in percent. *RST value is 30%.

:STATe?

:STATe ON | OFF | 1 | 0

Turns AM modulation ON or OFF. AM is not turned on by just setting AM:DEPTH. Turning AM modulation ON will not automatically turn OFF any other types of modulation. Turning any or all modulation types ON or OFF must be done explicitly. If a modulation type is turned ON while another modulation type is ON, an execution error -221 is generated, and the state of the instrument is unchanged. *RST value is OFF.

:SOURce?

:SOURce INTernal[1] [, EXTernal] |
EXTernal[, INTernal[1]] | INTernal2

Selects AM source. *RST value is INTernal. INTernal2 is the internal Option 1E2 Modulation Generator.

:EXTernal

:COUPling?

:COUPling AC | DC

Sets source coupling for AM. The GROund parameter defined by the 1991 SCPI Command Reference (17.1.9.2) is not supported. *RST value is DC.

:INTernal[1]

:FREQUency?

:FREQUency <NRf> [<freq term>]

Sets the frequency of the AM internal signal source. Legal values are 400 Hz and 1 kHz. *RST value is 1 kHz.

:INTernal2

:FREQUency?

:FREQUency <NRf> [<freq term>]

Sets the AM modulation frequency using the internal audio generator in the Option 1EP and the internal modulation generator in the Option 1E2. Legal values are 20 Hz to 10 kHz for the Option 1EP and 10 Hz to 20 kHz for the Option 1E2. *RST value is 1 kHz.

```
:INTernal2:FUNCTion
:SHAPE?
:SHAPE <shape>
```

Sets the AM modulation waveform for the internal modulation generator (Option 1E2 only). Legal values for shape are SINE, TRIangle, SQUare, and SAW. *RST value is SINE.

CAL Subsystem

```
[SOURce]
:CAL
:DCFM
```

Eliminates the offset in dc FM so that the carrier frequency remains the same with no modulation applied. External dc modulation must be on to implement this calibration, or execution error -221 is generated.

DM Subsystem (Option 1EP Only)

Note

Pager encoder programming commands are valid only for instruments with Option 1EP.

```
[SOURce]
:DM
[:DATA1]
:FORMat?
:FORMat FSK2 | FSK4
Sets DM modulation to FSK2 or FSK4. *RST value is FSK2.
:STATe?
:STATe ON | OFF | 1 | 0
```

Sets DM modulation ON or OFF. DM is not turned on by setting DM:DEVIation. Turning DM modulation ON will not automatically turn OFF any other types of modulation. Turning any or all modulation types ON or OFF must be done explicitly. If a modulation type is turned ON while another modulation type is ON, an execution error -221 is generated, and the state of the instrument is unchanged. *RST value is OFF.

```
:DEVIation?
:DEVIation <NRf> [<freq term>]
```

Sets DM modulation deviation. *RST value is 3 kHz.

```
:POLarity?
:POLarity NORMal | INVerted
```

Sets DM modulation polarity to normal or inverse. *RST value is NORMal.

```
:FILTer
:STATe?
:STATe ON | OFF | 1 | 0
```

Sets DM modulation filter on or off. *RST value is ON.

Note

To set or change the FSK level, the data rate must be set properly. For example, when you want to set the data rate to 6400 bps, 4-level FSK for FLEX pagers, send the following commands:

```
PAG:FLEX:RATE 6400
DM:FORM FSK4
DM:DEV 4.8 KHZ
DM:STAT ON
```

FM Subsystem

```
[SOURce]
:FM
[:DEVIation]?
[:DEVIation] <NRf> [<freq term>]
```

Sets FM deviation. *RST value is 3 kHz.

```
:STATe?
:STATe ON | OFF | 1 | 0
```

Turns FM modulation ON or OFF. FM is not turned on by just setting FM:DEVIation. Turning FM modulation ON will not automatically turn OFF any other types of modulation. Turning any or all modulation types ON or OFF must be done explicitly. If a modulation type is turned ON while another modulation type is ON, an execution error -221 is generated, and the state of the instrument is unchanged. *RST value is OFF.

```
:SOURce?
:SOURce INTernal[1][, EXTernal] |
EXTernal[, INTernal[1]] | INTernal2
```

Selects FM source. *RST value is INTernal. INTernal2 is the internal Option 1E2 Modulation Generator.

```
:EXTernal
:COUPling?
:COUPling AC | DC
```

Sets source coupling for FM. The GROund parameter defined by the 1991 SCPI Command Reference (17.4.9.2) is not supported. *RST value is DC.

```
:INTernal[1]
:FREQuency?
:FREQuency <NRf> [<freq term>]
```

Sets the frequency of the FM internal signal source. Legal values are 400 Hz and 1 kHz. *RST value is 1 kHz.

```
:INTernal2
:FREQuency?
:FREQuency <NRf> [<freq term>]
```

Sets the FM modulation frequency using the internal audio generator in the Option 1EP and the internal modulation generator in the Option 1E2. Legal values are 20 Hz to 10 kHz for the Option 1EP and 10 Hz to 20 kHz for the Option 1E2. *RST value is 1 kHz.

```
:INTernal2:FUNCTion
:SHAPE?
:SHAPE <shape>
```

Sets the FM modulation waveform for the internal modulation generator (Option 1E2 only). Legal values for shape are SINE, TRIangle, SQUare, and SAW. *RST value is SINE.

FREQuency Subsystem

```
[SOURce]
:FREQuency
[:CW | :FIXed]?
[:CW | :FIXed] <NRf> [<freq term>]
```

This function selects a frequency for the continuous wave, non- swept signal. *RST value is 100 MHz.

```
:REFerence?
:REFerence <NRf> [<freq term>]
```

Sets a reference value which, if STATE is ON, allows all frequency parameters to be queried/set as relative to the reference value. *RST value is 0 MHz.

```
:STATe?
:STATe ON | OFF | 1 | 0
```

Determines whether frequency is output in absolute or relative mode. *RST value is OFF.

INITiate Subsystem (Option 1EP Only)

```
INITiate
:IMMediate
```

This command starts pager encoding.

Note

Pager encoder programming commands are valid only for instruments with Option 1EP.

OUTPut Subsystem

```
OUTPut
:STATe?
:STATe ON | OFF | 1 | 0
```

This function controls the state of the RF output. When OUTPut:STATE is OFF, the RF source level is set to off. Turning OUTPut:STATE ON causes the programmed CW signal to be present at the output terminal. *RST value is OFF.

PAGing Subsystem (Option 1EP Only)

```
[SOURce]
: PAging
  [: FORMat]
    : SElect POCSag | FLEX | FTD | RESYnc | PN15
```

Sets the pager format to POCSAG, FLEX, FLEX-TD (FTD), RESYNC, or PN15. *RST value is FLEX.

For POCSAG/FLEX/FLEX-TD/PN15

```
[SOURce]
: PAging
  [: FORMat]
    : {POCSag | FLEX | FTD | PN15}
    : RATE?
    : RATE <NR1>
```

Sets the data rate as follows depending on the format selected:

For FLEX/FLEX-TD: 1600, 3200, or 6400.

For POCSAG: 512, 1200, or 2400.

For PN15: 512, 1200, 1600, 2400, 3200, 6400.

*RST value is 1600 for FLEX/FLEX-TD or 512 for POCSAG and PN15.

Note

To set or change the data rate, the FSK level must be set properly. For example, when you want to set the data rate to 6400 bps, 4-level FSK for FLEX pagers, send the following commands:

```
PAG:FLEX:RATE 6400
DM:FORM FSK4
DM:DEV 4.8 KHZ
DM:STAT ON
```

For POCSAG/FLEX/FLEX-TD

```
[SOURce]
: PAging
  [: FORMat]
    : {POCS | FLEX | FTD}
    : MESSage
    : SElect?
    : SElect <NR1>
```

Selects the message number which is to be encoded (0 for the arbitrary message; 1 to 5 for the fixed messages; 6 for the user definable message). *RST value is 1.

```
: DEFine?
: DEFine 'string'
```

Sets the user definable message (message 6) up to 40 characters. *RST value is "" (null).

```
:LENGth?  
:LENGth <NR1>
```

Sets the length of the user definable message. If the message length is longer than the number set here then the message is truncated to the given length. *RST value is 40.

```
[SOURce]  
:PAGing  
  [:FORMat]  
    :{POCS|FLEX|FTD}  
      :ARBitrary  
        :START?  
          :START <NR1>
```

Sets the start segment number of the buffer memory for the arbitrary message (message 0). *RST value is 0.

```
:STOP?  
:STOP <NR1>
```

Sets the stop segment number of the buffer memory for the arbitrary message (message 0). *RST value is 127.

```
:DEFine <NR1>, <NR1>, ... , <NR1>
```

Sets the data of a buffer memory segment for the arbitrary message (message 0). Legal values for each <NR1> are -32768 to 32767. *RST value is "" (null).

Note

See "Using the Buffer Memory for the Arbitrary Messages" for the usage of the buffer memory for the arbitrary messages.

The contents of data to be filled in <NR1>, <NR1>, ... , <NR1> format for the :DEFine command depends on the pager format, FLEX/FLEX-TD or POCSAG, as follows.

■ For FLEX/FLEX-TD

[Buffer No.], [Frame info (upper)], [Frame info (lower)],
[Data set 0], ... , [Data set n]

[Buffer No.] is the segment number of the buffer memory in which the data is stored (0 to 127).

[Frame info (upper)] and [Frame info (lower)] are the upper 16 bits and lower 16 bits of the frame information.

Each [Data set n] contains the upper 16 bits or lower 16 bits of the word as follows. The total number of the data sets (n) depends on the data rate.

Data Set No.	1600 bps	3200 bps	6400 bps
0 (Upper 16 bits) 1 (Lower 16 bits)	Word 0a of block 0	Word 0a of block 0	Word 0a of block 0
2 (Upper 16 bits) 3 (Lower 16 bits)	Word 1a of block 0	Word 0c of block 0	Word 0b of block 0
4 (Upper 16 bits) 5 (Lower 16 bits)	Word 2a of block 0	Word 1a of block 0	Word 0c of block 0
6 (Upper 16 bits) 7 (Lower 16 bits)	Word 3a of block 0	Word 1c of block 0	Word 0d of block 0
:	:	:	:
174 (Upper 16 bits) 175 (Lower 16 bits)	Word 7a of block 10	Word 3c of block 5	Word 5d of block 2
:	—	:	:
350 (Upper 16 bits) 351 (Lower 16 bits)	—	Word 7c of block 10	Word 3d of block 5
:	—	—	:
702 (Upper 16 bits) 703 (Lower 16 bits)	—	—	Word 7d of block 10

LSB and MSB are defined as follows.

Lower 16 bits	Upper 16 bits
LSB	MSB
1, 2, 3, ... , 15, 16,	17, 18, 19, ... , 31, 32

Example for FLEX/FLEX-TD

Suppose that you want to send the following message.

Data Rate: 1600 bps, 2-level FSK
 Cycle: 0, Frame: 0, Collapse cycle: 0, Repeat: 0
 Address: A0000001
 Message: 0123456[0]

Frame information bits and data sets should be as follows.

□ Frame information bits:

	Lower 16 bits LSB	Upper 16 bits MSB	
	0000000000000000 (0) (Frame info (upper))	0111100001000010 (16926) (Frame info (lower))	Frame info

□ Data Sets:

	Lower 16 bits LSB	Upper 16 bits MSB	
Word 0a of block 0	1110000000010000 (2055) (Data set 1)	0000001010011000 (6464) (Data set 0)	Block info
Word 1a of block 0	1000000000000001 (-32767) (Data set 3)	0000010110010011 (-13920) (Data set 2)	Address field
Word 2a of block 0	1001110110000010 (16825) (Data set 5)	0110001110101110 (30150) (Data set 4)	Vector field
Word 3a of block 0	0100001000010011 (-1427) (Data set 7)	0000111010110010 (19824) (Data set 6)	Message field
Word 4a of block 0	0101001101111000 (7882) (Data set 9)	0011110010010101 (-22212) (Data set 8)	Message field
Word 5a of block 0	0000000000000000 (0) (Data set 11)	0000000000000000 (0) (Data set 10)	Idle frame
Word 6a of block 0	1111111111111111 (-1) (Data set 13)	1111111111111111 (-1) (Data set 12)	Idle frame
Word 7a of block 0	0000000000000000 (0) (Data set 15)	0000000000000000 (0) (Data set 14)	Idle frame
:	:	:	Idle frame
Word 6a of block 10	1111111111111111 (-1) (Data set 173)	1111111111111111 (-1) (Data set 172)	Idle frame
Word 7a of block 10	0000000000000000 (0) (Data set 175)	0000000000000000 (0) (Data set 174)	Idle frame

The data to be sent by the :DEFine command for the above example is as follows, when the segment number of the buffer memory in which the data is stored is 8:

```

8, 16926, 0,
  Buffer No., Frame info (Upper), Frame info (Lower)
6464, 2055, -13920, -32767, 30150, 16825, 19824,
-14270,
  Data sets 0 to 7
-22212, 7882, 0, 0, -1, -1, 0, 0,
  Data sets 8 to 15
-1, -1, 0, 0, -1, -1, 0, 0,
  Data sets 16 to 23
:
-1, -1, 0, 0, -1, -1, 0, 0
  Data sets 168 to 175

```

■ For POCSAG

[Buffer No.], [Data set 0], . . . , [Data set 31]

[Buffer No.] is the number of the buffer memory segment in which the data is stored (0 to 127).

[Data set 0] to [Data set 31] are assigned as follows:

```

[Data set 0] : Upper 16 bits of 1st codeword of frame 0
[Data set 1] : Lower 16 bits of 1st codeword of frame 0
[Data set 2] : Upper 16 bits of 2nd codeword of frame 0
[Data set 3] : Lower 16 bits of 2nd codeword of frame 0
[Data set 4] : Upper 16 bits of 1st codeword of frame 1
:
[Data set 31] : Lower 16 bits of 2nd codeword of frame 7

```

LSB and MSB are defined as follows.

Upper 16 bits	Lower 16 bits
MSB	LSB
1, 2, 3, . . . , 15, 16,	17, 18, 19, . . . , 31, 32

Note

Note that the meanings of “MSB”/“LSB” and “upper”/“lower” are reversed between FLEX/FLEX-TD and POCSAG.

For FLEX/FLEX-TD

```
[SOURce]
  :PAGing
    [:FORMat]
      :{FLEX|FTD}
        :TYPE?
          :TYPE  TONE | NUMeric | ALPHanumeric |
                HBINary
```

Sets the type of message. *RST value is NUMeric.

Note

ALPHanumeric supports the 7-bit coded character set (ISO/IEC 646) only.

```
:VECTor?
:VECTor  STANdard | SPECial | NUMBered
```

Sets the type of numeric message. *RST value is STANdard.

STANdard: Displays the received numeric message on the pager-under-test.

SPECial: Converts the received numeric message to the pre-defined message and displays it on the pager-under-test.

NUMBered: The message numbers are assigned for each paging address separately starting at 0 and progressing up to a maximum of 63 in consecutive order.

```
:NUMBer?
:NUMBer  <NR1>
```

Sets the initial number of numeric messages to be sent (0 to 63). *RST value is 0.

```
:HBINary?
:HBINary  BIT1 | BIT7 | BIT8 | BIT14 | BIT16
```

Sets the bits per character of HEX/Binary message.
*RST value is BIT1.

BIT1: 1 bit per character
BIT7: 7 bits per character
BIT8: 8 bits per character
BIT14: 14 bits per character
BIT16: 16 bits per character

```
:CODE?
:CODE  'string'
```

Sets the pager capcode (address) up to 16 characters. The frame, phase, collapse cycle, and short/long address are automatically determined using the FLEX/FLEX-TD standard rule. Setting each value after this command is sent overwrites the value. *RST value is "A0000001".

```
[SOURce]
  :PAGing
    [:FORMat]
      :{FLEX|FTD}
        :CYCLe?
          :CYCLe <NR1>
```

Sets the cycle number (0 to 4). *RST value is 0.

```
:FRAMe?
:FRAMe <NR1>
```

Sets the frame number (0 to 127). *RST value is 0.

```
:CCOunt?
```

Returns the current cycle number during encoding.

```
:FCOunt?
```

Returns the current frame number during encoding.

```
:PHASe?
:PHASe A|B|C|D
```

Sets the phase (A, B, C, or D). *RST value is A.

```
:COLLapse?
:COLLapse <NR1>
```

Sets the collapse cycle (0 to 7). *RST value is 4.

```
[SOURce]
  :PAGing
    [:FORMat]
      :{FLEX|FTD}
        :ATYPe?
          :ATYPe  SHORt | LONG
```

Sets the address type to SHORt or LONG. *RST value is SHORt.

```
:ADDR1?
:ADDR1  <NR1>
```

Sets the short address or the primary address of the long address.
*RST value is 0032679.

```
:ADDR2?
:ADDR2  <NR1>
```

Sets the secondary address of the long address. *RST value is
0000000.

Note

To set the address of the pager under test, use the ATYPe, ADDR1, and ADDR2 commands. The following commands are left to keep the compatibility of the programs developed under the older revision firmware.

```
:SADDress?
:SADDress  <NR1>
```

Sets the 7-digit short address. *RST value is 0032769.

```
:LADD1?
:LADD1  <NR1>
```

Set the 7-digit long address 1. *RST value is 0032769.

```
:LADD2?
:LADD2  <NR1>
```

Set the 7-digit long address 2. *RST value is 0000000.

```

[SOURce]
  :PAGing
    [:FORMat]
      :{FLEX|FTD}
        :ISTop
          :STATe?
            :STATe  ON | OFF | 1 | 0

```

Sets the instrument behavior as follows when a stop event occurs.
 *RST value is OFF.

ON | 1 : Terminates the encoder signal output immediately.
 OFF | 0 : Terminates the encoder signal output just before the next instance the pager is on. (If :TERMinator:STATe is set to ON, the encoder generates the asynchronous frame when the pager is on.)

```

  :HEADer
    :STATe?
      :STATe  ON | OFF | 1 | 0

```

Sets the header on or off. Header is the idle frame which is sent before the actual message. *RST value is ON.

```

  :TERMinator
    :STATe?
      :STATe  ON | OFF | 1 | 0

```

Sets the terminator on or off. Terminator is the asynchronous frame which is sent at the end of the message stream. *RST value is ON.

```

  :VECTor?
    :VECTor  STANdard | SPECial

```

Sets the type of numeric message. *RST value is STANdard.

STANdard: Displays the received numeric message on the pager-under-test.
 SPECial: Converts the received numeric message to the pre-defined message and displays it on the pager-under-test.

```

  :HBINary?
    :HBINary  BIT1 | BIT8 | BIT16

```

Sets the bits per character of HEX/Binary message.
 *RST value is BIT1.

BIT1: 1 bit per character
 BIT8: 8 bits per character
 BIT16: 16 bits per character

```

[SOURce]
  :PAGing
    [:FORMat]
      :{FLEX|FTD}
        :DCAL1
          :STATe?
            :STATe  ON | OFF | 1 | 0

```

Sets the dummy call function to ON or OFF. *RST value is OFF.

- ON: Activates the Dummy Call function. Sets a message with all 5s (0101 in numeric format), which is automatically defined, to the all non-call phases to equalize the FSK deviation. An address for the non-call phases must be set.
- OFF: Does not activate the dummy call function. Idle frames are set to the all non-call phases.

```

:ADDR{1|2}?
:ADDR{1|2} <NR1>

```

Sets the dummy call address 1 and 2. *RST values are 0032769 for address 1 and 0000000 for address 2.

```

:ROAMing
  :SELEct?
  :SELEct  NONE | SSID | NID

```

Selects the roaming mode to NONE, SSID, or NID. *RST value is NONE.

- NONE: Tests a pager without the roaming mode.
- SSID: Tests a pager in the SSID roaming mode which responds to a simulcast transmission system. The Frame Offset function is added.
- NID: Tests a pager in the SSID and NID roaming mode. The NID mode, in addition to the SSID mode, is a roaming network for covering wider multiple areas.

```
[SOURce]
  :PAGing
    [:FORMat]
      :{FLEX|FTD}
        :ROAMing
          :SSID
            :LID?
            :LID <NR1>
```

Sets the SSID local channel ID (0 to 511) of a pager under test. *RST value is 0.

```
:CZONe?
:CZONe <NR1>
```

Sets the coverage zone (0 to 31) of a pager under test. *RST value is 0.

```
:CCODe?
:CCODe <NR1>
```

Sets the country code (0 to 1023). *RST value 0.

```
:TMF?
:TMF <NR1>
```

Sets the SSID traffic management flag (0 to 15). *RST value is 2.

```
:FOFF?
:FOFF <NR1>
```

Sets the number of frames to be offset by BIW101 from the signaling frame at the home area (0 to 63). *RST value is 0.

```
:NID
:ADDRESS?
:ADDRESS <NR1>
```

Sets the NID address (2058240 to 2062335). *RST value is 2058240.

```
:CHANnel?
:CHANnel <NR1>
```

Sets the RF channel number (0 to 7). *RST value is 0.

```
:AREA?
:AREA <NR1>
```

Sets the service area identification (0 to 31). *RST value is 0.

```
:MULTiplier?
:MULTiplier <NR1>
```

Sets how much the network address is extended (0 to 7). *RST value is 0.

```
:TMF?
:TMF <NR1>
```

Sets the NID traffic management flag (0 to 15). *RST value is 2.

For FLEX-TD only

```
[SOURce]
  :PAGing
    [:FORMat]
      :FTD
        :REPeat?
        :REPeat <NR1>
```

Sets the number of repeats (0 to 3). *RST value is 0.

```
:RC0unt?
```

Returns the current number of repeats during encoding.

For POCSAG

```
[SOURce]
  :PAGing
    [:FORMat]
      :POCSag
        :TYPE?
        :TYPE TONE | NUMeric | ALPHanumeric |
              ALPH7 | ALPH8
```

Sets the type of message. *RST value is NUMeric.

Note

ALPH7 and ALPH8 are entered in hex-binary codes and can be used for displaying two-byte characters, for example Chinese characters, through a conversion table. Refer to POCSAG in Chapter 1b.

```
:FUNction?
:FUNction <NR1>
```

Sets the POCSAG function bit [0 (=00), 1 (=01), 2 (=10), 3 (=11)]. *RST value is 0.

```
:CODE?
:CODE <NR1>
```

Sets the 7-digit pager capcode (address) for POCSAG. *RST value is "0000000".

PM Subsystem

[SOURce]

:PM

[:DEVIation]?

[:DEVIation] <NRf> [<angle term>]

Sets PM deviation in radians. *RST value is 1.0 RAD.

:STATe?

:STATe ON | OFF | 1 | 0

Turns PM modulation ON or OFF. PM is not turned on by just setting PM:DEVIation. Turning PM modulation ON will not automatically turn OFF any other types of modulation. Turning any or all modulation types ON or OFF must be done explicitly. If a modulation type is turned ON while another modulation type is ON, an execution error -221 is generated, and the state of the instrument is changed. *RST value is OFF.

:SOURce?

:SOURce INTernal[1][, EXTernal] |
EXTernal[, INTernal[1]] | INTernal2

Selects PM source. *RST value is INTernal. INTernal2 is the internal Option 1E2 Modulation Generator.

:EXTernal

:COUPling?

:COUPling AC | DC

Sets source coupling for PM. The GROUND parameter defined by the 1991 SCPI Command Reference (17.10.9.2) is not supported. *RST value is DC.

:INTernal[1]

:FREQuency?

:FREQuency <NRf> [<freq term>]

Sets the frequency of the PM internal signal source. Legal values are 400 Hz and 1 kHz. *RST value is 1 kHz.

:INTernal2

:FREQuency?

:FREQuency <NRf> [<freq term>]

Sets the PM modulation frequency using the internal audio generator in the Option 1EP and the internal modulation generator in the Option 1E2. Legal values are 20 Hz to 10 kHz for the Option 1EP and 10 Hz to 20 kHz for the Option 1E2. *RST value is 1 kHz.

:INTernal2:FUNCTion

:SHAPE?

:SHAPE <shape>

Sets the PM modulation waveform for the internal modulation generator (Option 1E2 only). Legal values for shape are SINE, TRIangle, SQUare, and SAW. *RST value is SINE.

POWer Subsystem

```
[SOURce]
:POWer
[:LEVel] [:IMMediate] [:AMPLitude]?
```

Returns the value of the current CW amplitude. The return value is in units of DBM if POWer:REFerence:STATe is OFF, or it is in DB, relative to the current value of POWer:REFerence if POWer:REFerence:STATe is ON.

```
[:LEVel] [:IMMediate] [:AMPLitude] <NRf> [<ampl
term>]
```

Sets CW amplitude. *RST value is -136 dBm.

```
:ATTenuation
:AUTO?
:AUTO ON | OFF | 1 | 0
```

When set ON, the firmware will control the attenuators. Turning it OFF causes the attenuator range to hold to its present setting. *RST value is ON.

```
:REFerence?
:REFerence <NRf> [<ampl term>]
```

Sets a reference value which, if STATe is ON, allows all amplitude parameters to be queried/set as relative to the reference value. *RST value is 0 dBm.

```
:STATe?
:STATe ON | OFF | 1 | 0
```

Determines whether amplitude is output in absolute or relative mode. *RST value is OFF.

PULM Subsystem

```
PULM
:STATe?
:STATe ON | OFF | 1 | 0
```

This function controls the state of the pulse modulation. *RST value is OFF.

STATus Subsystem

STATus
:QUESTionable
[:EVENT]?

Returns the contents of the event register associated with the status structure.

:CONDition?

Returns the contents of the condition register associated with the status structure. Reading the condition register is non-destructive.

:ENABle <NR1>

Sets the enable mask which allows true conditions in the event register to be reported in the summary bit.

:ENABle?

Queries the enable mask.

:PAGing
[:Event]?
:CONDition?
:ENABle <NR1>
:ENABle?

The start of frame/batch and the end of message encoding can be detected by checking this register status with serial polling.

Note

Pager encoder programming commands are valid only for instruments with Option 1EP.

```
:POWer  
[:EVENT]?  
:CONDition?  
:ENABle <NR1>  
:ENABle?  
  
:MODulation  
[:EVENT]?  
:CONDition?  
:ENABle <NR1>  
:ENABle?  
  
:CALibration  
:FEXTension  
[:EVENT]?  
:CONDition?  
:ENABle <NR1>  
:ENABle?
```

SYSTEM Subsystem

SYSTEM
:LANGUage "COMP" | "SCPI"

Causes the signal generator to perform a language switch to 8656/57-compatible language or to SCPI. For example:
OUTPUT 719; "SYST:LANG " "COMP"" sets the language to 8656/57-compatible language. A 0.5 second WAIT statement is required after changing languages. The rear panel language switch is read once at power-up so if the language has been remotely selected, it will revert to the switch setting when power is cycled.

:ERRor?

Returns any system error message. The format of the response is <error number>,<error string>.

:VERSion?

Returns a formatted numeric value corresponding to the SCPI version number for which the instrument complies. The format of the response is YYYY.V. The Ys represent the year version (for example, 1990) and the V represents an approved revision number for that year.

TRIGger Subsystem (Option 1EP Only)

Note

Pager encoder programming commands are valid only for instruments with Option 1EP.

TRIGger
:COUNT?
:COUNT <NR1>

This command sets the number of times the pager signal will be sent out. A count set at 1 and collapse cycle set to 0 represent the single mode. A count set from 1 to 256 represents the burst mode. A count set at 0 represents the continuous mode. *RST value is 1.

For the resynchronization function set by the [SOURCE] :PAGing [:FORMat] :SElect RESYnc command, this command defines the number of bursts of the resynchronization pattern (0 to 256). One burst is 1.92 s. 0 represents the continuous mode. *RST value is 1.

Note

The meaning of this TRIGger:COUNT command changes with the firmware revision B.04.00 as described above. For the older version firmware, this TRIGger :COUNT command defines the number of the frames (for FLEX/FLEX-TD) or batches (for POCSAG) to be actually output for the arbitrary message.

Changing Parameters While Encoding (Option 1EP only)

The contents of the capcode and its related parameters such as address can be changed via GPIB without stopping encoding at all while testing a pager.

The new contents affected by this change will be transmitted normally from the third frame following the first frame since this GPIB command has been received. For getting the exact information of the frame affected, it is recommended to monitor the Paging Status Register Bit 0 (Start of frame). This indicates when the frame, to which this GPIB command is sent, starts.

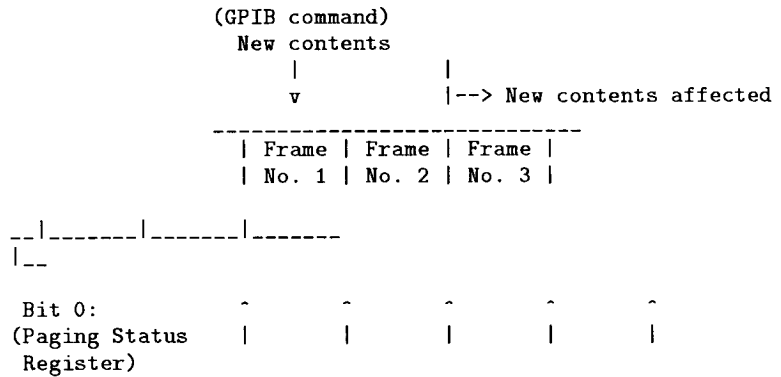

Note

The frequency value and amplitude value can be also changed via GPIB without stopping encoding, and these values will be changed immediately after the GPIB commands for these changes are sent.

Note

The message should not be changed during the repeat frames when testing a FLEX-TD pager.

Using the Buffer Memory for the Arbitrary Messages

(Option 1EP only)

Using the buffer memory enables you to send the arbitrary messages (message 0) up to 128 frames for FLEX/FLEX-TD or 128 batches for POCSAG. The buffer memory consists of the 128 segments numbered from 0 to 127.

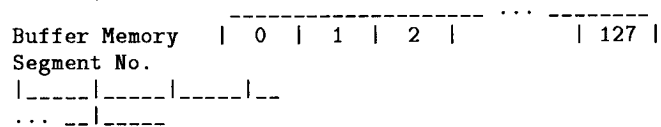

The arbitrary messages can contain the following data.

FLEX/FLEX-TD: Frame Information and Block data
POCSAG: Message Codeword data

In other words, the arbitrary messages *cannot* contain the following data, and the 8648A Option 1EP automatically generates these data.

FLEX/FLEX-TD: Sync 1 and Sync 2 data
POCSAG: Pre-amble and the Synchronization Codeword data

The data of each buffer memory segment can only be entered from the external controller using the [SOURCE] :PAGing [:FORMat] :{POCS|FLEX|FTD} :ARBitrary :DEFine GPIB command. Refer to "PAGING Subsystem (Option 1EP Only)" for the details of this command usage.

Note

Since the arbitrary message cannot set the data rate and the modulation settings, set them using the following commands.

■ For FLEX/FLEX-TD

```
PAG:{FLEX|FTD}:RATE {1600|3200|6400}  
DM:FORM {FSK2|FSK4}  
DM:DEV 4.8 KHZ  
DM:STAT {ON|1}
```

■ For POCSAG

```
PAG:POCS:RATE {512|1200|2400}  
DM:FORM FSK2DM:DEV 3 KHZ  
DM:STAT {ON|1}
```

When transmitting the arbitrary message, the start and stop segment numbers of the buffer memory can be specified. The start and stop values are set in the Message Menu (START FRAME and STOP FRAME for FLEX/FLEX-TD; START BATCH and STOP BATCH for POCSAG) from the front panel or by the [SOURCE] :PAGing [:FORMat] :{POCS|FLEX|FTD} :ARBitrary :STARt and :STOP GPIB commands from the external controller.

For example, when the start and stop segment numbers of the buffer memory are 8 and 11 respectively, and the encoding mode is burst (the number of times is 2), the actual transmitted data is illustrated as follows.

```
-----  
Buffer Memory | 8 | 9 | 10 | 11 | 8 | 9 | 10 | 11 |  
Segment No.  |_____|_____|_____|_____|_____|_____|_____|_____|  
              |_____|_____|_____|_____|_____|_____|_____|_____|
```

GPIB Capabilities

The instrument is designed to be compatible with a controller that interfaces in terms of the bus codes summarized in the table. This table describes each of the interface functions that are available with this instrument as defined by the IEEE 488.2-1987.

Table 2-3. IEEE 488.2 Capabilities

Capability	Code	Comment
Source Handshake	SH1	Full Capability
Acceptor Handshake	AH1	Full Capability
Talker	T6, TE0	Basic Talker, Serial Poll, untalk on MLA
Listener	L4, LE0	Basic Listener, unlisten on MTA
Service Request	SR1	Full Capability
Remote Local	RL1	Full Capability
Parallel Poll	PP0	No Capability
Device Clear	DC1	Full Capability
Device Trigger	DT0	No Capability
Controller	C0	No Capability
Electrical Interface	E2	Tristate (1 Mbps max)

GPIB Connector Information



General Purpose Interface Bus

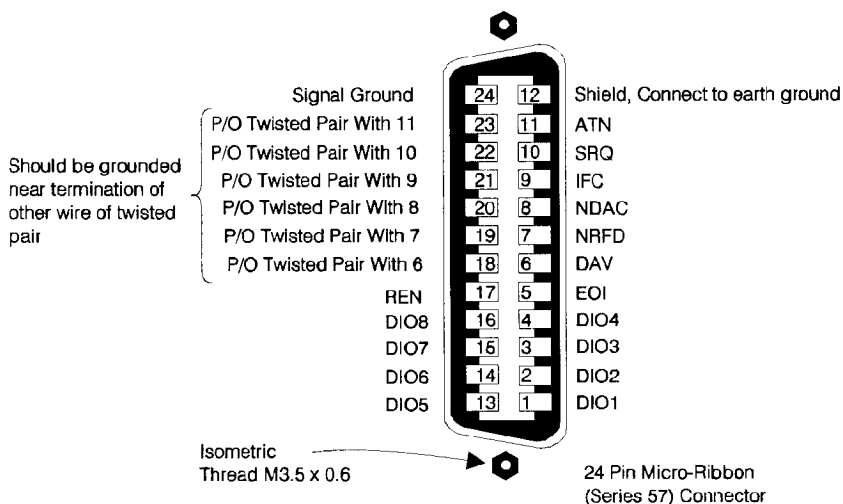

Logic Levels

The General Purpose Interface Bus Logic levels are TTL compatible, that is, the true (1) state is 0.0 Vdc to + 0.4 Vdc and the false state (0) is +2.5 Vdc to +5 Vdc.

Mating Connector

1251-0293; Amphenol 57-30240

Mating Cables Available

- 10833A, 1 meter (3.3 ft.)
- 10833B, 2 meter (6.8 ft.)
- 10833C, 4 meter (13.2 ft.)
- 10833D, 0.5 meter (1.6 ft.)

Cabling Restrictions

1. General Purpose Interface System may contain no more than 2 meters (6.6 ft.) of connecting cable per instrument.
2. The maximum accumulative length of connecting cables for any General Purpose Interface System is 20 meters (65.5 ft.).

8656/57 Compatible Language

The 8648 signal generator can be operated remotely using either SCPI or 8656/57-compatible language. SCPI is the recommended language for remote programming and all features are supported. 8656/57-compatible language is offered so that the 8648 signal generator can be used as a replacement for the 8656B and 8657A/B. The 8648 is not fully compatible with programs developed for the 8656/57 but with the following minor changes, it can be:

- On the 8656/57, if the SCPI code turns RF to off and then changes amplitude, the RF automatically turns back on. For this same SCPI code to work in the 8648, the following line of code must be added to turn the RF back on: `OUTP:STAT ON`.
- On the 8656/57, a line terminator is not required to execute a line of code. For the 8648, however, a new line is required.

Send the SCPI command `SYST:LANG "COMP"` to change from SCPI to 8656/57-compatible language or change the setting of the rear panel language switch. The switch is read once at power-up so if the language has been remotely selected, it will revert to the switch setting when power is cycled.

Program Code Implementation

For users of 8656/57-compatible language, the following table shows which program codes are implemented (not all of the codes could be implemented).

8656/57-Compatible Program Codes

Program Code*	Parameter	Comments	Status
AM	Amplitude Modulation	Function Entry	Implemented
AO	Amplitude Offset	Function Entry	Implemented
AP	Amplitude (carrier)	Function Entry	Implemented
DB	dB	Units Entry	Implemented
DF	dBf	Units Entry	Implemented
DM	dBm	Units Entry	Implemented
DN	Step Down (↓)	Function Feature	Implemented
EM	EMF	Units Entry	Implemented
FM	Frequency Modulation	Function Entry	Implemented
FR	Frequency (carrier)	Function Entry	Implemented
GT	Flexible Sequence	Feature	Implemented
HI	HI ALC	Function Feature	Implemented
HZ	Hz	Units Entry	Implemented
IS	Increment Set	Function Qualifier	Implemented
KZ	kHz	Units Entry	Implemented
LO	LO ALC	Function Feature	Not Implemented
MV	mV	Units Entry	Implemented
MZ	MHz	Units Entry	Implemented
PC	Percent [†]	Units Entry	Implemented
PD	Phase Decrement	Function Feature	Not Implemented
PF	Pulse Modulation (Fast Mode)	Function Entry	Not Implemented
PI	Phase Increment	Function Feature	Not Implemented
PM	Pulse Modulation	Function Feature	Not Implemented
QS	Reverse Sequence	Feature	Implemented

* Program codes can be either upper or lower case.
[†] Either PC or % can be used.

8656/57-Compatible Program Codes (continued)

Program Code*	Parameter	Comments	Status
RC	Recall (0-9)	Feature	Implemented
RL	Recall (0-99)	Feature	Implemented
RP	Reverse Power Protection Reset [†]	Feature	Implemented
R0	Standby	Feature	Not Implemented
R1	On	Feature	Not Implemented
R2	RF Off	Function Feature	Not Implemented [§]
R3	RF On	Function Feature	Implemented
R5	RF Dead (Full Attenuator)	Function Feature	Implemented
SQ	Sequence	Feature	Implemented
ST	Save (0-9)	Feature	Implemented
SV	Save (0-99)	Feature	Implemented
S1	External Modulation Source	Source Qualifier	Implemented
S2	Internal 400 Hz Modulation Source	Source Qualifier	Implemented
S3	Internal 1 kHz Modulation Source	Source Qualifier	Implemented
S4	Modulation Source Off	Source Qualifier	Implemented
S5	DC FM	Function Entry	Implemented
UP	Step Up (↑)	Function Feature	Implemented
UV	μV	Units Entry	Implemented
VL	Volts	Units Entry	Implemented
0-9	Numerals 0-9	Data Entries	Implemented
-	Minus Sign	Data Entry	Implemented
.	Decimal Point	Data Entry	Implemented
%	Percent [†]	Units Entry	Implemented

* Program codes can be either upper or lower case.
[†] Either PC or % can be used.
[‡] The source of reverse power must be removed.
[§] The 8648 does not implement this command but if "R2" is received, "R5" is executed.

Receiving the Clear Message

The signal generator responds to a clear message by presetting the instrument. The preset conditions are different depending on which language is selected. The following table shows the differences between a clear message in the compatibility language and a *RST in SCPI. The parameters for the 8656B and 8657A/B are shown for comparison.

Parameter	8648 *RST Value	8648 Compatibility Value	8656B Value	8657A/B Value
Carrier Frequency	100.00000 MHz	100.00000 MHz	100.00000 MHz	100.00000 MHz
Output Amplitude	-136 dBm	-136 dBm	-127 dBm	-143.5 dBm
AM Depth	30%	0%	0%	0%
FM Peak Deviation	1.0 kHz	0.0 kHz	0.0 kHz	0.0 kHz
Carrier Frequency Increment	10.00000 MHz	10.00000 MHz	10.00000 MHz	10.00000 MHz
Output Amplitude Increment	1.0 dB	10.0 dB	10.0 dB	10.0 dB
AM Depth Increment	0.1%	1%	1%	1%
FM Peak Deviation Increment	100 kHz	1.0 kHz	1.0 kHz	1.0 kHz
Coarse and Fine Tune Pointer	10.00000 MHz	10.00000 MHz	10.00000 MHz	10.00000 MHz
Sequence Counter	Remain unchanged	0	0	0
100 Saved Set Ups	Remain unchanged	Remain unchanged	Remain unchanged	Remain unchanged
Pulse Modulation	Off	Remain unchanged	Remain unchanged	Remain unchanged

Additional Programming Information

For additional 8656/57 programming information, refer to the *HP 8656B, HP 8657A, HP 8657B Synthesized Signal Generator Operation and Calibration Manual*.

3 Installation

This chapter provides information about the following:

- unpacking the signal generator
- connecting ac power
- turning on the signal generator
- connecting to other instruments
- storing the signal generator
- shipping the signal generator

Unpacking Your Signal Generator

1. Unpack the contents of the shipping container.

2. Inspect the shipping container for damage.

If the shipping container is damaged or the cushioning material inside is stressed, keep them until you have checked the instrument for proper operation.

3. Inspect the signal generator to ensure that it was not damaged during shipment.

If mechanical damage or defects have occurred, notify the carrier as well as Agilent Technologies. Keep the shipping materials for inspection by the carrier.

WARNING **To avoid hazardous electrical shock, do not connect ac power to the instrument when there are any signs of shipping damage to any portion of the outer enclosure (cover and panels).**

CAUTION **Ventilation Requirements:** When installing the instrument in a cabinet, the convection into and out of the instrument must not be restricted. The ambient temperature (outside the cabinet) must be less than the maximum operating temperature of the instrument by 4 °C for every 100 watts dissipated in the cabinet. If the total power dissipated in the cabinet is greater than 800 watts, then forced convection must be used.

Connecting AC Power

WARNING This is a Safety Class I product (provided with a protective earthing ground incorporated in the power cord). The mains plug shall only be inserted in a socket outlet provided with a protective earth contact. Any interruption of the protective conductor, inside or outside the instrument, is likely to make the instrument dangerous. Intentional interruption is prohibited.

If this instrument is to be energized via an external autotransformer for voltage reduction, make sure that its common terminal is connected to a neutral (earthed pole) of the power supply.

This instrument is equipped with a three-wire power cable. When connected to an appropriate ac power receptacle, this cable grounds the instrument cabinet. The type of mains plug shipped with each instrument depends on the country of destination. Refer to Figure 302 for the part numbers of the power cables and mains plugs available.

Power Requirements

The signal generator requires a power source of either 50/60/400 Hz at 100/120 V or 50/60 Hz at 200/240 V. The voltage ranges for these nominal voltage values are shown in the following table. Power consumption is 170 VA maximum.

Available AC Voltage	Voltage Range
100 V	90 to 110 Vrms
120 V	108 to 132 Vrms
220 V	198 to 242 Vrms
240 V	216 to 250 Vrms

CAUTION This instrument has autoranging line voltage input; be sure the supply voltage is within the specified range.

Replacing the Fuse

If a fuse failure is suspected, replace the 250 V, 3 A, type F fuse (part number 2110-0780) as follows:

1. Unplug the power cord from the line module.
2. use a flat-blade screw driver to pry and unseat the fuse housing from the line module.
3. Remove the cartridge and inspect the fuse positioned toward the front of the instrument.

Figure 3-1. Replacing the Fuse

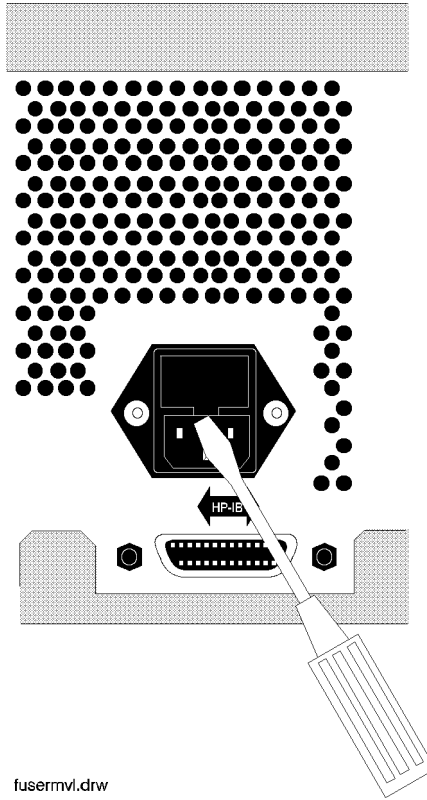
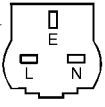
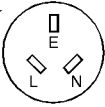

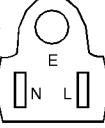
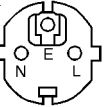
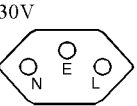
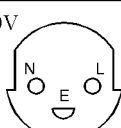
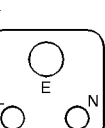
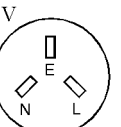

Figure 3-2. Power Cable and Mains Plug

Plug Type ^a	HP Cable Part Number	Plug ^b Description	Length cm (in.)	Cable Color	For Use in Country
250V 	8120-1351	Straight BS 1363A	229 (90)	Mint Gray	Option 900 United Kingdom, Hong Kong, Cyprus, Nigeria, Singapore, Zimbabwe
	8120-1703	90°	229 (90)	Mint Gray	
250V 	8120-1369	Straight AS 3112	210 (79)	Gray	Option 901 Argentina, Australia, New Zealand, Mainland China
	8120-0696	90°	200 (78)	Gray	
125V 	8120-1378	Straight NEMA 5-15P	203 (80)	Jade Gray	Option 903 United States, Canada, Brazil, Colombia, Mexico, Philippines, Saudi Arabia, Taiwan
	8120-1521	90°	203 (80)	Jade Gray	
125V 	8120-4753	Straight NEMA 5-15P	229 (90)	Gray	Option 918 Japan
	8120-4754	90°	229 (90)	Gray	
250V 	8120-1689	Straight CEE 7/VII	200 (78)	Mint Gray	Option 902 Continental Europe, Central African Republic, United Arab Republic
	8120-1692	90°	200 (78)	Mint Gray	
230V 	8120-2104	Straight SEV Type 12	200 (78)	Gray	Option 906 Switzerland
	8120-2296	90°	200 (78)	Gray	
220V 	8120-2956	Straight SR 107-2-D	200 (78)	Gray	Option 912 Denmark
	8120-2957	90°	200 (78)	Gray	
250V 	8120-4211	Straight IEC 83-B1	200 (78)	Mint Gray	Option 917 South Africa, India
	8120-4600	90°	200 (78)	Mint Gray	
250V 	8120-5182	Straight SI 32	200 (78)	Jade Gray	Option 919 Israel
	8120-5181	90°	200 (78)	Jade Gray	

a. E =earth ground, L = line, and N = neutral.

b. Plug identifier numbers describe the plug only. The HP part number is for the complete cable assembly.

formt118

Turning On the Signal Generator

If you are operating this instrument in extreme environmental conditions, refer to the following operation limitations.

The following minimum conditions are required for safe operation of this instrument:

- indoor use
- altitude < 4500 meters (15,000 feet)
- temperature: 0 ° to 50 °C
- maximum relative humidity 80% for temperature up to 31 °C decreasing linearly to 50% relative humidity at 40 °C
- INSTALLATION CATEGORY II according to IEC 1010
- POLLUTION DEGREE 2 according to IEC 664

The instrument performs a diagnostic self test on power-up. If any problems are detected with functionality it will display a message. Refer to Chapter 1c, “Operation Messages,” for further information about the messages.

Connecting to Other Instruments

Coaxial mating connectors used with the signal generator should be either 50 Ω BNC or 50 Ω type N male connectors that are compatible with those specified in UL MIL-C39012.

Storing the Signal Generator

The instrument should be stored in a clean, dry environment. The following environmental limitations apply to both storage and shipment:

- temperature $-40\text{ }^{\circ}\text{C}$ to $+70\text{ }^{\circ}\text{C}$
- humidity $< 95\%$ relative
- altitude 15,300 meters (50,000 feet)

NOTE The cabinet should only be cleaned using a damp cloth.

Shipping the Signal Generator

Containers and materials identical to those used in factory packaging are available through Agilent Technologies. If the instrument is being returned to Agilent Technologies for servicing, attach a tag indicating the type of service required, return address, model number, and full serial number. Also, mark the container FRAGILE to assure careful handling. In any correspondence, refer to the instrument by model number and full serial number.

If you are using other packaging, follow the guidelines below.

1. Wrap the instrument in heavy paper or plastic.
2. Use a strong shipping container. A double-wall carton made of 2.4 MPa (350 psi) test material is adequate.
3. Use enough shock-absorbing material (75 to 100 millimeter layer; 3 to 4 inches) around all sides of the instrument to provide a firm cushion and to prevent movement in the container. Protect the front panel with cardboard.
4. Seal the shipping container securely.
5. Mark the shipping container FRAGILE to assure careful handling.

Specifications

This chapter contains specifications and supplemental characteristics for the 8648A/B/C/D synthesized signal generators.

- **Specifications** describe the instrument's warranted performance over the 0 to 50 °C temperature range and apply after a 30 minute warm-up unless otherwise noted. All performance below a carrier frequency of 250 kHz is typical.
- **Supplemental characteristics** (shown in italics) are intended to provide information useful in estimating instrument capability in your application by describing typical, but non-warranted performance.

The regulatory information is located in the last section of this chapter.

Options

The 8648A/B/C/D synthesized signal generator specifications refer to several options. Those options are described below.

- Option 1EA – High power (8648B/C/D only)
- Option 1EP – Pager encoder/signaling (includes modulation generator functionality of Option 1E2) (8648A only)
(Not available with Option 1E2)
- Option 1E2 – Modulation generator (Not available with Option 1EP)
- Option 1E5 – High stability timebase
- Option 1E6 – Pulse modulation (8648B/C/D only)

Option Specifications

Specifications unique to instruments with Options 1E2, 1E6, or 1EP are listed *after* the general specifications.

Frequency Specifications

Range	
8648A	100 kHz to 1000 MHz
8648B	9 kHz to 2000 MHz
8648C	9 kHz to 3200 MHz
8648D	9 kHz to 4000 MHz

Resolution	0.001 Hz
Display	10 Hz

Accuracy*	<i>Typically $\pm 3 \times 10^{-6}$ x carrier frequency in Hz. Typically $\pm 0.15 \times 10^{-6}$ x carrier frequency in Hz for Option 1E5.</i>
------------------	--

* After one hour warm-up and within one year of calibration.

Switching Speed (typical)	
< 1001 MHz	< 75 ms
\geq 1001 MHz	< 100 ms

Internal Reference Oscillator

Accuracy and stability* (typical, calibration and adjustment dependent)	\pm Aging rate \pm temperature effects \pm line voltage effects
--	---

* After one hour warm-up and within one year of calibration.

	Standard Timebase (typical)	High Stability Timebase Option 1E5
Aging	< ± 2 ppm/year	< ± 0.1 ppm/year* or < ± 0.0005 ppm/day*
Temperature	< ± 1 ppm	< ± 0.01 ppm [†] (typical)
Line Voltage[‡]	< ± 0.5 ppm	N/A

* After four days warm-up and within one year of calibration.
[†] Specification applies at 25 ° \pm 5 °C.
[‡] Specification applies for a line voltage change of $\pm 5\%$.

Output	10 MHz, typically > 0.5 V _{rms} level into 50 ohms
---------------	---

External reference oscillator input	Accepts 2, 5, 10 MHz ±5 ppm and a level range of 0.5 V to 2 V _{rms} into 50 ohms
--	---

Output

Range		
8648A		+ 10 to -136 dBm
8648B/C/D		
≤ 2500 MHz		+ 13 to -136 dBm
≤ 4000 MHz		+ 10 to -136 dBm
Maximum Levelled*		
< 100 kHz	Option 1EA	Option 1EA and 1E6
< 100 MHz	+ 17 dBm	+ 13 dBm
≤ 1000 MHz	+ 20 dBm	+ 13 dBm (typically + 16 dBm)**
≤ 1500 MHz	+ 20 dBm	+ 18 dBm
≤ 2100 MHz	+ 19 dBm	+ 17 dBm
≤ 2500 MHz	+ 17 dBm	+ 15 dBm
≤ 4000 MHz	+ 15 dBm	+ 13 dBm
	+ 13 dBm	+ 11 dBm
* Typical for f _c < 250 kHz.		
** Combining Option 1E6 with 1EA reduces output levels by 2 dB, below 100 MHz only + 13 dBm (typically + 16 dBm) is specified.		

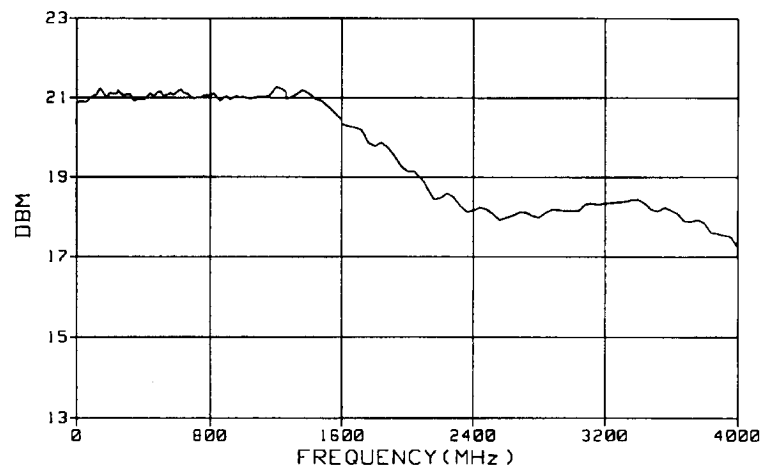

Figure 4-1. Typical Output Power with Option 1EA

Display Resolution	0.1 dB
---------------------------	--------

Accuracy* † ‡	≥ -100 dBm	< -100 dBm
$f_c < 100 \text{ kHz}$	±1.0 dB	±3.0 dB
$f_c \leq 2500 \text{ MHz}$	±1.0 dB	±1.0 dB
$f_c \leq 3200 \text{ MHz}$	±1.5 dB	±3.0 dB
$f_c \leq 4000 \text{ MHz}$	±2.0 dB	±3.0 dB

* Accuracy is valid from maximum specified output power to -127 dBm. Below -127 dBm, accuracy is typically ±3.0 dB for frequencies between 100 kHz and 2500 MHz and is not specified for frequencies outside of this range.

† Accuracy applies at 25 ±5 °C, and typically degrades up to ±0.5 dB over 0 to 50 °C or at output power levels > 13 dBm.

‡ Accuracy is typical for $f_c < 250 \text{ kHz}$.

Reverse power protection	
≤ 2000 MHz	50 watts into 50 ohms
≤ 4000 MHz	25 watts into 50 ohms

SWR (output < -6 dBm, typical)	
< 249 kHz	< 2.5:1
< 2500 MHz	< 1.5:1
≤ 4000 MHz	< 2.0:1

Output Impedance	Nominally 50 ohms
-------------------------	-------------------

Spectral Purity

Harmonics	< -30 dBc (output ≤ +4 dBm)
------------------	-----------------------------

Subharmonics (output ≤ +4 dBm)	
< 1001 MHz	-60 dBc
≤ 3200 MHz	-50 dBc
≤ 4000 MHz	-40 dBc

Nonharmonics (≥ 5 kHz offset, $\leq +4$ dBm output level)	
< 249 MHz	< -55 dBc
< 1001 MHz	< -60 dBc
< 2001 MHz	< -54 dBc
≤ 4000 MHz	< -48 dBc

Residual FM (CCITT, rms)	
< 249 MHz	< 7 Hz, <i>typically</i> < 4 Hz
< 501 MHz	< 4 Hz, <i>typically</i> < 2 Hz
< 1001 MHz	< 7 Hz, <i>typically</i> < 4 Hz
< 2001 MHz	< 14 Hz, <i>typically</i> < 8 Hz
≤ 4000 MHz	< 28 Hz, <i>typically</i> < 12 Hz

SSB Phase Noise (<i>at 20 kHz offset, typical</i>)	
at f_c 500 MHz	< -120 dBc/Hz
at f_c 1000 MHz	< -116 dBc/Hz
at f_c 2000 MHz	< -110 dBc/Hz
at f_c 3000 MHz	< -106 dBc/Hz
at f_c 4000 MHz	< -104 dBc/Hz

Frequency Modulation

Peak Deviation (rates > 25 Hz ac FM)	
< 249 MHz	0 to 200 kHz
< 501 MHz	0 to 100 kHz
< 1001 MHz	0 to 200 kHz
< 2001 MHz	0 to 400 kHz
≤ 4000 MHz	0 to 800 kHz

Resolution	
$\leq 10\%$ peak deviation	
< 2001 MHz	10 Hz
≥ 2001 MHz	20 Hz
> 10% to maximum peak deviation	
< 2001 MHz	100 Hz
≥ 2001 MHz	200 Hz

Deviation Accuracy (internal 1 kHz rate) < 1001 MHz < 2001 MHz ≤ 4000 MHz	±3% of FM deviation ±30 Hz ±3% of FM deviation ±60 Hz ±3% of FM deviation ±120 Hz
---	---

Rates Internal Option 1E2 External DC External AC	400 Hz or 1 kHz 10 Hz to 20 kHz <i>dc to 150 kHz (typical, 3 dB BW)</i> <i>1 Hz to 150 kHz (typical, 3 dB BW)</i>
--	--

Distortion (1 kHz rate, THD + N, 0.3 to 3 kHz BW) < 1001 MHz < 2001 MHz ≤ 4000 MHz (88 to 108 MHz)	< 1% at deviations > 4 kHz < 1% at deviations > 8 kHz < 1% at deviations > 16 kHz (< 0.5% at deviations ≤ 75 kHz)
---	--

Carrier frequency accuracy relative to CW in dc FM* < 1001 MHz < 2001 MHz ≤ 4000 MHz	±100 Hz (<i>typically 40 Hz</i>) at deviations < 10 kHz ±200 Hz (<i>typically 80 Hz</i>) at deviations < 20 kHz ±400 Hz (<i>typically 160 Hz</i>) at deviations < 40 kHz
--	--

* Specifications apply over the 25 ±5 °C range within 1 hour of DC FM calibration.

FM + FM	Internal 1 kHz or 400 Hz source plus external. In internal plus external FM mode, the internal source produces the set level of deviation. The external input should be set to ≤ ±0.5 Vpk or 0.5 Vdc (one-half of the set deviation).
----------------	---

Phase Modulation

Peak Deviation Range < 249 MHz < 501 MHz < 1001 MHz < 2001 MHz ≤ 4000 MHz	0 to 10 radians 0 to 5 radians 0 to 10 radians 0 to 20 radians 0 to 40 radians
---	--

Resolution < 2001 MHz ≥ 2001 MHz	0.01 radian 0.02 radian
---	----------------------------

Deviation Accuracy (internal 1 kHz rate, typical) < 1001 MHz < 2001 MHz ≤ 4000 MHz	±3% of deviation setting ±0.05 radians ±3% of deviation setting ±0.1 radians ±3% of deviation setting ±0.2 radians
--	--

Rates Internal Option 1E2 External	400 Hz or 1 kHz 20 Hz to 10 kHz 20 Hz to 10 kHz (typical, 3 dB BW)
--	--

Distortion (1 kHz rate) < 1001 MHz < 2001 MHz ≤ 4000 MHz	< 1% at deviations ≥ 3 radians < 1% at deviations ≥ 6 radians < 1% at deviations ≥ 12 radians
--	---

Amplitude Modulation

AM performance is not specified below 1.5 MHz and is typical above 1001 MHz.

Range	0 to 100%; output ≤ 4 dBm
--------------	---------------------------

Resolution	0.1%
-------------------	------

Accuracy* (1 kHz rate)	±5% of setting ±1.5%
-------------------------------	----------------------

* Applies at 25 ±5 °C and at < 70% depth; AM accuracy is typically ±7% of setting ±1.5% over 0 to 50 °C.

Rates Internal Option 1E2 External: DC AC	400 Hz or 1 kHz 10 Hz to 20 kHz <i>dc to 25 kHz (typical, 3 dB BW)</i> <i>1 Hz to 25 kHz (typical, 3 dB BW)</i>
---	--

Distortion (1 kHz rate, THD + Noise, 0.3 to 3 kHz BW)	
8648A	
at 30% AM	< 2%
at 90% AM	< 3%
8648B/C/D	
at 30% AM	< 2%
at 70% AM	< 3%

Modulation Source

Internal	400 Hz or 1 kHz, front panel BNC connector provided at nominally 1 V _p into 600 ohms. (See also "Modulation Generator Option 1E2".)
External	1 V _p into 600 ohms (nominal) required for full scale modulation. (High/Low indicator provided for external signals ≤ 10 kHz.)

Remote Programming

Interface	GPIB (IEEE-488.2-1987) with Listen and Talk
Control Languages	SCPI version 1992.0 8656B and 8657 code compatibility
Functions Controlled	All functions are programmable except the front-panel power key, the knobs, the increment set key, the arrow keys, the reference keys, and the rear-panel display contrast control.
IEEE-488 Functions	SH1, AH1, T6, TE0, L4, LE0, SR1, RL1, PP0, DC1, DT0, C0, E2

Environmental

Operating temperature range Shock and vibration Leakage	0 to 50 °C Meets MIL STD 28800E Type III, Class 5 Conducted and radiated interference meets MIL STD 461B RE02 Part 2 and CISPR 11. <i>Leakage is typically < 1 μV (nominally 0.1 μV with a 2 turn loop) at ≤ 1001 MHz, when measured with a resonant dipole antenna one inch from any surface (except the rear panel) with output level < 0 dBm (all inputs/outputs properly terminated).</i>
--	---

General

Power Requirements Internal Diagnostics Storage Registers Weight 8648A 8648B/C/D Dimensions	90 to 264 V; 48 to 440 Hz; 170 VA maximum Automatically executes on instrument power-up. Assists user in locating instrument errors and locating faulty module. 300 storage registers with sequence and register number displayed. Up to 10 sequences are available with 30 registers each. 7 kg (15 lbs) net; 9 kg (20 lbs) shipping 8.5 kg (19 lbs) net; 11 kg (24 lbs) shipping 165H x 330W x 368D mm (6.5H x 13W x 14.6D in.)
--	--

Options 1EA 1E2 1E5 1E6 1EP 1CM 0B0 0B1 W30	High power (8648B/C/D only) Modulation generator (Not available with Option 1EP) High stability timebase Pulse modulation (8648B/C/D only) Pager encoder/signaling (includes modulation generator functionality of Option 1E2) (8648A only) (Not available with Option 1E2) Rack kit, part number 08648-60001 Delete manual Extra manual (includes service information) Three year warranty
---	---

Translated Operating Manuals	
Option AB0	Chinese for Taiwan, part number 08648-90002
Option AB1	Korean, part number 08648-90006
Option AB2	Chinese for PRC, part number 08648-90004
Option ABE	Spanish, part number 08648-90003
Option ABD	German, part number 08648-90019
Option ABF	French, part number 08648-90020
Option ABJ	Japanese, part number 08648-90005

Accessories	
Transit Case	Part number 5961-4720
Remote Interface	83300A
Memory Interface	83301A

Modulation Generator Option 1E2

Adds variable frequency modulation source. (This functionality is also included with the pager encoder/signaling Option 1EP.)

Waveforms	sine, triangle, square, and sawtooth (or ramp)
------------------	--

Frequency Range	
Sine	10 Hz to 20 kHz
Square, Triangle, Sawtooth (or ramp)	100 Hz to 2 kHz*

* Useable from 10 Hz to 20 kHz. However, bandwidth limitations may result in waveform degradation. Refer to AM, FM, and Phase Modulation Rate specifications (External AC mode).

Frequency Accuracy	<i>Typically $\pm 0.01\%$</i>
---------------------------	--

Frequency Resolution	1 Hz (3 digits or 10 Hz displayed)
-----------------------------	------------------------------------

Depth and Deviation Accuracy (1 kHz sine)	Refer to AM, FM, and Phase Modulation Accuracy specifications.
--	--

Output Front Panel BNC	Nominally 1 Vp
----------------------------------	----------------

Pulse Modulation Option 1E6

Rise/Fall Time	< 10 ns
-----------------------	---------

On/Off Ratio < 2000 MHz ≤ 4000 MHz	> 80 dB > 70 dB
---	--------------------

Maximum Pulse Repetition Rate	10 MHz
--------------------------------------	--------

Supplemental Information Pulse Input Delay Video Feedthrough	TTL level (±15 V maximum) < 60 ns, <i>typical</i> < 30 mV, <i>typical</i>
--	---

Pager Encoder/Signaling Option 1EP

Frequency

Accuracy with Option 1E5*	<i>Typically $\pm 0.15 \times 10^{-6}$ x carrier frequency in Hz or 0.092×10^{-6} x carrier frequency in Hz within 90 days of calibration.</i>
----------------------------------	---

* After one hour warm-up and within one year of calibration.

Frequency Modulation

FSK Deviation Accuracy with Option 1EP	± 60 Hz*
* Specifications apply over the 25 ± 5 °C range, 4.8 kHz deviation. Meets FLEX requirements at 274 to 288, 322 to 329, 929 to 932 MHz.	

Pager Signaling

Supported Pager Protocols POCSAG Speed Message Format FLEX/FLEX-TD Speed 2 Level FSK 4 Level FSK Message Format Address Type Supported Roaming Method Messaging Accessible From Front Panel or GPIB Message Types Message Length Repetition Modes Messaging Accessible Only Over GPIB Message Type Batch Length FLEX/FLEX-TD POCSAG Repetition Mode Data Rate Accuracy	POCSAG, FLEX™*, and FLEX-TD 512, 1200, and 2400 bps Tone only, Numeric, Alphanumeric, Alphanumeric entered by hex-bin code, Pseudo-noise (15-stage) 1600 and 3200 bps 3200 and 6400 bps Tone only, Numeric (standard, special, and numbered), Alphanumeric, HEX/Binary, Pseudo-noise (15-stage), Re-synchronization Short, Long SSID, NID Five fixed (built-in), one user-defined 40 characters maximum Single, Burst, Continuous arbitrary (user-defined) 128 Frames 128 Batches Single, Burst, and Continuous ± 5 ppm†
* FLEX is a trademark of Motorola, Inc. † Specifications apply over the 25 ± 5 °C range.	

Modulation Source

Internal	400 Hz or 1 kHz, or audio generator (see Option 1E2 for characteristics), front panel BNC connector provided at nominally 1 Vp into 600 ohms.
-----------------	---

General

Storage Registers	70 storage registers with sequence and register number displayed. Up to 10 sequences are available with 30 registers each.
--------------------------	--

Regulatory Information

ISO 9002 Compliant

The 8648A/B/C/D signal generators are manufactured in an ISO 9002 registered facility in concurrence with Agilent Technologies' commitment to quality.

Statement of Compliance

This instrument has been designed and tested in accordance with IEC Publication 348, Safety Requirements for Electronic Measuring Apparatus, and has been supplied in a safe condition. The instruction documentation contains information and warnings which must be followed by the user to ensure safe operation and to maintain the instrument in a safe condition.

Noise Declaration

Notice for Germany: Noise Declaration
LpA < 70 dB
am Arbeitsplatz (operator position)
normaler Betrieb (normal position)
nach DIN 45635 T. 19 (per ISO 7779)

DECLARATION OF CONFORMITY

according to ISO/IEC Guide 22 and EN 45014

Manufacturer's Name:

Hewlett-Packard Co.

Hewlett-Packard Ltd.

Manufacturer's Address:

Microwave Instruments Division
1400 Fountaingrove Parkway
Santa Rosa, CA 95403-1799
USA

Queensferry Microwave Division
South Queensferry
West Lothian
EH30 9TG
United Kingdom

declares that the products

Product Name:

RF Signal Generator

Model Number:

HP 8648A, HP 8648B, HP 8648C, HP 8648D

Product Options:

This declaration covers all options of the above products.

conform to the following Product specifications:

Safety: IEC 1010-1:1990+A1 / EN 61010-1:1993
CAN/CSA-C22.2 No. 1010.1-92

EMC: CISPR 11:1990 / EN 55011:1991 Group 1, Class A
IEC 801-2:1984 / EN 50082-1:1992 4 kV CD, 8 kV AD
IEC 801-3:1984 / EN 50082-1:1992 3 V/m, 27-500 MHz
IEC 801-4:1988 / EN 50082-1:1992 0.5 kV Sig. Lines, 1 kV Power Lines
IEC 555-2:1982 +A1:1985 / EN 60555-2:1987
IEC 555-3:1982 + A1:1990 / EN 60555-3:1987 + A1:1991

Supplementary Information:

These products herewith comply with the requirements of the Low Voltage Directive 73/23/EEC and the EMC Directive 89/336/EEC and carry the CE-marking accordingly.

Santa Rosa, 19 Dec. 1996

John Hiatt/Quality Engineering Manager

South Queensferry, 27 Dec. 1996

R. M. Evans/Quality Manager

European Contact: Your local Hewlett-Packard Sales and Service Office or Hewlett-Packard GmbH, Department ZQ/Standards Europe, Herrenberger Strasse 130, D-71034 Böblingen, Germany (FAX +49-7031-14-3143)

5 Service

This chapter provides procedures for troubleshooting your instrument to the assembly level. It is organized in four sections.

- Chapter 5
 - introductory information
 - shipping instructions
 - complete list of equipment required for all adjustments and performance tests
 - post-repair instructions
 - safety notes
- Chapter 5a
 - simplified block diagram of instrument's operation
 - theory of operation for each major assembly
- Chapter 5b
 - troubleshooting checklist
 - ac mains (line) fuse removal
 - modulation test points and power supply LEDs diagram
 - power supply distribution diagram
 - instrument block diagram
- Chapter 5c
 - service error messages including description of the error, possible causes, and resolutions

Shipping Your Instrument Back to Agilent Technologies

If it becomes necessary to ship your instrument back to Agilent Technologies, use the original packaging or something comparable that provides sufficient padding to protect the instrument. (See Chapter 3, “Installation,” for more detailed packaging information.) Fill out a blue repair tag and attach it to the instrument. Repair tags are located at the end of this manual behind the index.

A list of Agilent Technologies offices is located at the front of this book.

Recommended Test Equipment

The following table lists the recommended test equipment required for performance tests and adjustments. If the recommended equipment is not available, substitute it with equipment that meets the critical specifications for the recommended model.

Table 5-1. Recommended Test Equipment

Instrument	Critical Specifications	Recommended Model	Use	
			Performance Test - (P) Adjustment - (A) Supp. Verification Test - (V)	
50Ω Feedthrough	Resistance: 50Ω ±1% Maximum SWR: dc to 100 kHz: 1.1	10100C	LF Output Level LF Power Level Accuracy	(A) (A)
Amplifier, Low Frequency	Freq. range: 100 kHz to 1300 MHz Gain (mean, per channel): ≥ 25 dB Noise Figure: < 8.5 dB	8447D	Power Level Accuracy HF Power Level Accuracy	(P) (A)
Amplifier, High Frequency	Freq. range: 1300 kHz to 4 GHz Gain (mean, per channel): ≥ 26 dB Noise Figure: ≤ 8.5 dB	8449B	Power Level Accuracy HF Power Level Accuracy	(P) (A)
Attenuator 6 dB	Freq. range: 100 kHz to 4 GHz Maximum SWR: < 1.2	8491A/B Option 006	Power Level Accuracy HF Power Level Accuracy LF Power Level Accuracy	(P) (A) (A)
Attenuator 10 dB	Freq. range: 100 kHz to 4 GHz Maximum SWR: < 1.2	8493A Option 010	DC FM Frequency Error RF Level Accuracy CW Frequency Accuracy	(P) (P) (V)
Audio Analyzer	Distortion accuracy: ±1 dB Residual distortion: -80 dB at 80 kHz BW 30 kHz low-pass filter AC level accuracy: ±4% CCITT weighting filter	8903B Option 051	FM Distortion AM Distortion Phase Modulation Distortion Residual FM AM Modulator	(P) (P) (P) (P) (A)
Personal Computer	CPU: 386 or better Clock: 33 MHz or faster RAM: 8 Mb or more Disk Drive: 3.5 inch Hard Drive: 350 Mb or more Monitor: 16 color VGA MS Windows® 3.x or MS Windows 95, 98, NT GPIB Interface Card: 82341C	Any that meets the requirements	Automated Adjustments and Performance Tests	
DVM	Range: -50 V to +50 V functions: DC and AC DC accuracy: 0.01% Input impedance: > 10 MW AC range: 100 kHz AC accuracy: ±0.1%	3458A	AM Level and Distortion AM Level AM Level: FE AM Modulator Motherboard Audio Path Audio Generator LF Output Level LF Power Level Accuracy 9 kHz RF Level Accuracy	(A) (A) (A) (A) (A) (A) (A) (A) (V)
Frequency Counter	Freq. range: 10 MHz to 4000 MHz Freq. accuracy: ±35 Hz at 4000 MHz (Includes reference and counter accuracy)	5350B	DC FM Frequency Error CW Frequency Accuracy	(P) (V)

Table 5-1. Recommended Test Equipment

Instrument	Critical Specifications	Recommended Model	Use	
			Performance Test - (P) Adjustment - (A) Supp. Verification Test - (V)	
Frequency Counter	Resolution: 0.1 Hz	5316B	Internal Reference Oscillator (Manual Adjustment)	(A)
Function Generator	Freq. range: 1 kHz Amplitude: 4 Vpk DC output: ± 4 Vdc	33120A	AM Level and Distortion AM Level AM Level:FE AM Modulator Motherboard Audio Path	(A) (A) (A) (A) (A)
Measuring Receiver	FM Accuracy: $\pm 2\%$ of reading ± 1 digit AM accuracy: $\pm 2\%$ of reading ± 1 digit Range: 250 kHz to 1000 MHz Filters: 300 Hz high-pass; 15 kHz low-pass Detectors: Peak+	8902A	FM Accuracy FM Distortion AM Accuracy Phase Modulation Distortion Residual FM RF Level Accuracy AM Modulator Motherboard Audio Path	(P) (P) (P) (P) (P) (P) (A) (A)
Oscilloscope	Bandwidth: 1 GHz	54100A	Pulse Modulation On/Off Ratio Pulse Modulation Rise Time	(P) (P)
Oscilloscope	Bandwidth: 100 MHz	54600B	Internal Timebase: Aging Rate	(P)
Power Meter	Instrumentation accuracy: $\pm 0.5\%$ Power reference accuracy: 0.9%	438A	RF Level Accuracy Power Level Accuracy Detector Offset Output Level Predistortion & Detector Offset Prelevel Output Level:FE HF Power Level Accuracy	(P) (P) (A) (A) (A) (A) (A) (A)
Power Sensor	Freq. range: 100 kHz to 4.2 GHz Power range: -30 dBm to $+13$ dBm Maximum SWR: 100 kHz to 300 kHz 1:1.6 300 kHz to 1 MHz 1:1.2 1 MHz to 2 GHz 1:1.1 2 GHz to 4.2 GHz 1:1.3 Cal factor accuracy (RSS): $\leq 1.6\%$	8482A	RF Level Accuracy Power Level Accuracy Detector Offset Output Level Predistortion & Detector Offset Prelevel Output Level: FE HF Power Level Accuracy	(P) (P) (A) (A) (A) (A) (A) (A)
Power Sensor (Low)	Freq. range: 100 kHz to 4.2 GHz Power range: -70 dBm to -20 dBm Maximum SWR: 100 kHz to 300 kHz 1:1.2 300 kHz to 2 GHz 1:1.15 2 GHz to 4.2 GHz 1:1.4 Power linearity (-30 to -20 dBm): $\pm 1\%$ Cal factor accuracy: $< 1.6\%$	8481D Option H70	RF Level Accuracy	(P)
Primary Frequency Standard	Frequency: 10 MHz Stability: $> 1 \times 10^{-10}$ /year	5071A or 5061A/B	Internal Timebase: Aging Rate Internal Reference Oscillator (Manual Adjustment) Time Base DAC (Automated Adjustment)	(P) (A) (A)

Table 5-1. Recommended Test Equipment

Instrument	Critical Specifications	Recommended Model	Use	
			Performance Test - (P) Adjustment - (A) Supp. Verification Test - (V)	
Pulse/Function Generator	Frequency: 10 MHz Duty cycle: 50% Output: TTL square wave	8116A	Pulse Modulation On/Off Ratio Pulse Modulation Rise Time	(P) (P)
RF Mixer	Freq. range (RF and LO ports): 1 MHz to 2800 MHz Freq. range (IF port): 1 MHz to 2000 MHz Maximum input (LO port): +26 dBm	M/A Com Inc. MDC-174	FM Accuracy FM Distortion Phase Modulation Distortion Residual FM	(P) (P) (P) (P)
RF Mixer ^a	Freq. range (RF and LO ports): 500 MHz to 900 MHz Freq. range (IF port): 10 MHz to 2000 MHz Maximum input (LO port): +24 dBm	M/A Com Inc. MDC-164	FM Accuracy FM Distortion Phase Modulation Distortion Residual FM	(P) (P) (P) (P)
RF Spectrum Analyzer	Freq. range: 1 MHz to 4000 MHz Relative level accuracy (harmonic and spurious measurements): ±2 dB 1 Hz digital resolution BW filter (required for power accuracy) Displayed average noise: 100 kHz: -110 dBm 1 MHz to 10 MHz: -130 dBm 10 MHz to 4 GHz: -134 dBm RF Input VSWR: 1:1.5 External timebase input	8563E	Power Level Accuracy Harmonics Spurious Pulse Modulation On/.Off Ratio Time Base DAC HF Power Level Accuracy LF Power Level Accuracy	(P) (P) (P) (P) (A) (A) (A)
Sensor Module	No Substitute	11722A	RF Level Accuracy	(P)
Synthesized Signal Generator	Freq. range: 11.5 to 1500 MHz Output level: +16 dBm Meets 8663A single-sideband phase noise specifications	8663A	FM Accuracy FM Distortion Phase Modulation Distortion Residual FM	(P) (P) (P) (P)
Universal Counter (Low Frequency) ^b	Freq. accuracy: ±2 millihertz at 1600 Hz	5334B Option 010	Pager Encoder Timebase Accuracy Pager Encoder Timebase Freq	(P) (A)
Vector Signal Analyzer	FSK Deviation Accuracy: ±10 Hz at 4.8 kHz deviation	89441A	FSK Deviation Accuracy FSK Deviation Filter Path	(P) (A) (A)

- a. Required for testing 8648B/D only.
b. For use in testing 8648A Option 1EP only.

Post-Repair

Table 5-2. Adjustments and performance Tests Required after Repair or Replacement of an 8648A Assembly

Assembly	Adjustments	Performance Tests
A1 Front Panel	None	RF Level Accuracy Power Level Accuracy ^a
A2 Power Supply	All	All
A3 Motherboard Assembly	All	All
A3A1 memory Board	None	Power-on Self Test
A3BT1 Battery	DC FM ^a	DC FM Frequency Error
A4 Reference	Time Base DAC ^a	Residual FM Internal Timebase: Aging Rate ^b
A5 Sig Gen Synth	DC FM ^a FSK Deviation ^{ab}	FM Accuracy FM Distortion Phase Modulation Distortion Residual FM Harmonics Spurious DC FM Frequency Error FSK Deviation Accuracy
A6 Output	AM Level and Distortion ^a Detector Offset ^a Output Level ^a AM Modulator ^a HF Power Level Accuracy ^a	AM Accuracy AM Distortion Harmonics Spurious RF Level Accuracy Power Level Accuracy ^a
A7 Attenuator	HF Power Level Accuracy ^a	RF Level Accuracy Power Level Accuracy ^a
A9 Filtered Line Module	None	Power-on Self Test
A14 Modulation Generator	Audio Generator ^{ac}	FM Accuracy ^c AM Accuracy ^c
A30 Pager Encoder	Audio Generator ^{ad} Pager Encoder Timebase Calibration ^d HF Power Level Accuracy ^{ad} FSK Deviation ^{ad} Filter Path ^{ad}	RF level Accuracy Power Level Accuracy ^a Pager Encoder Timebase Accuracy ^b FSK Deviation Accuracy ^b
B1 Fan	None	Power-on Self Test
S1 Line Switch	None	RF Level Accuracy Power Level Accuracy ^a

- a. Adjustment or performance test is automated
- b. Option 1E5 only
- c. Option 1E2 only
- d. Option 1EP only

Table 5-3. Adjustments and Performance Tests Required after Repair or Replacement of an 8648B/C/D Assembly

Assembly	Adjustments	Performance Tests
A1 Front Panel	None	RF Level Accuracy Power Level Accuracy ^a
A2 Power Supply	All	All
A3 Motherboard Assembly	All	All
A3A1 memory Board	None	Power-on Self Test
A3BT1 Battery	DC FM ^a	DC FM Frequency Error
A4 Reference	Time Base DAC ^a	Residual FM Internal Timebase: Aging Rate ^b
A5 Sig Gen Synth	DC FM ^a	FM Accuracy FM Distortion Phase Modulation Distortion Residual FM Harmonics Spurious DC FM Frequency Error
A6 Output	AM Level ^a AM Level: FE ^a Predistortion and Detector Offset ^a Prelevel ^a Output Level ^a HF Power Level Accuracy ^a LF Output Level ^a HF Power Level Accuracy ^a	AM Accuracy AM Distortion Harmonics Spurious RF Level Accuracy Power Level Accuracy ^a
A9 Filtered Line Module	None	Power-on Self Test
A10 Frequency Extension	AM Level ^a AM Level: FE ^a Predistortion and Detector Offset ^a Prelevel ^a Output Level: FE ^a HF Power Level Accuracy ^a LF Output Level ^a LF Power Level Accuracy ^a	AM Accuracy AM Distortion Harmonics Spurious RF Level Accuracy Power Level Accuracy ^a
A11 Attenuator	HF Power Level Accuracy ^a LF Power Level Accuracy ^a	RF Level Accuracy Power Level Accuracy ^a
A12 Reverse Power Protection	HF Power Level Accuracy ^a LF Power Level Accuracy ^a	RF Level Accuracy Power Level Accuracy ^a
A13 Pulse Modulator Module (1E6)	HF Power Level Accuracy ^a LF Power Level Accuracy ^a	RF Level Accuracy Power Level Accuracy ^a Pulse Modulation On/Off Ratio Pulse Modulation Rise Time

Table 5-3. Adjustments and Performance Tests Required after Repair or Replacement of an 8648B/C/D Assembly

Assembly	Adjustments	Performance Tests
A14 Modulation Generator 91E2)	Audio Generator ^{ac}	FM Accuracy ^c AM Accuracy ^c
B1 Fan	None	Power-on Self Test
S1 Line Switch	None	RF Level Accuracy Power Level Accuracy ^a

- a. Adjustment or performance test is automated.
- b. Option 1E5 only
- c. Option 1E2 only

Safety Notes

WARNING **These servicing instructions are for use by qualified personnel only. To avoid electrical shock, do not perform any servicing unless you are qualified to do so.**

WARNING **The opening of covers or removal of parts is likely to expose dangerous voltages. Disconnect the instrument from all voltage sources while it is being opened.**

WARNING **The power cord is connected to internal capacitors that may remain live for ten seconds after disconnecting the plug from its power supply.**

WARNING **This is a Safety Class 1 Product (provided with a protective earthing ground incorporated in the power cord). The mains plug shall only be inserted in a socket outlet provided with a protective earth contact. Any interruption of the protective conductor inside or outside of the instrument is likely to make the instrument dangerous. Intentional interruption is prohibited.**

WARNING **For continued protection against fire hazard, replace fuse only with same type and rating (type F, 250 V, 3 A). The use of other fuses or materials is prohibited.**

5a Theory of Operation

Use the simplified block diagrams and the circuit descriptions in this chapter to understand the instrument's operation.

Figure 5a-1. 8648A Simplified Block Diagram

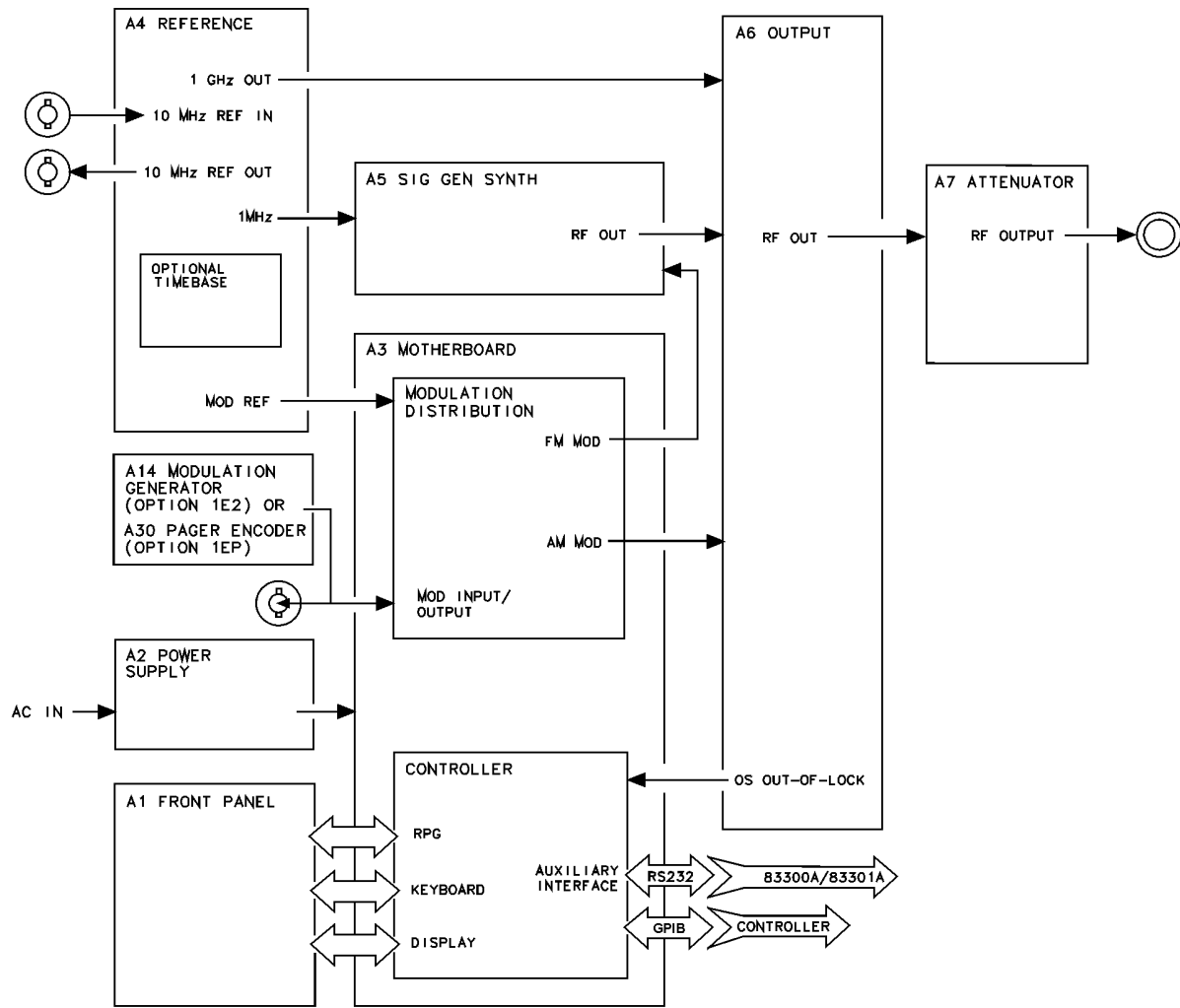

on621a2d

Figure 5a-2. 8648B/C/D Simplified Block Diagram

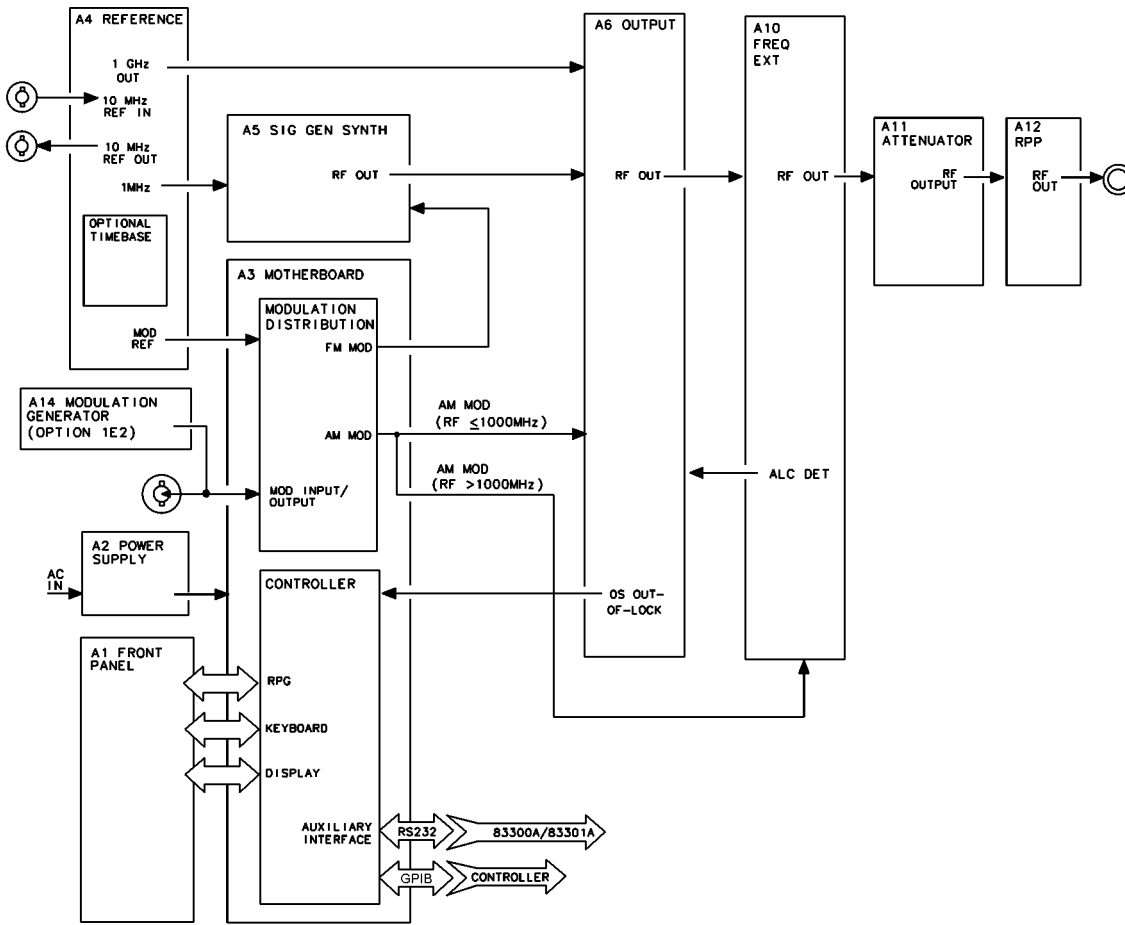

on615bd

Overview

The 8648A/B/C/D signal generator covers the frequency ranges shown in the following table.

Model	Frequency Range
8648A	100 kHz to 1000 MHz
8648B	9 kHz to 2000 MHz
8648C	9 kHz to 3200 MHz
8648D	9 kHz to 4000 MHz

The frequency bands are:

- 0.1 to < 249 MHz
- 249 to < 501 MHz
- 501 to < 1001 MHz
- 1001 to < 2001 MHz
- 2001 to 4000 MHz

The output amplitude range is from +10 to -136 dBm except for frequencies 2500 MHz on the 8648B/C/D where the higher end of the range is +13 dBm.

The 8648A/B/C/D supports AM, FM, and phase modulation. The possible modulation sources are:

- internal 400 Hz or 1 kHz source
- external ac- or dc-coupled source
- internal 1 kHz plus external dc-coupled source
- internal variable frequency/waveform source (Option 1E2 only)

A1 Front Panel

The front panel contains two RPGs (rotary pulse generators), the keyboard, and the display.

The two RPGs, one for frequency and one for amplitude, are connected directly to the controller on the A3 board. Each RPG receives power and ground from the controller. Each RPG returns two out-of-phase pulsed lines when the knob is turned.

The keyboard is a matrix of keys as shown in Table 5-1. on page 5-6. The keyboard is scanned by the controller. Scanning pulses are sent alternately to the keyboard rows and are read back on the columns when a key is pressed. The controller determines which key was pressed based on the row that was pulsed and the column that the signal was returned on. The column lines are pulled-up through resistors and are pulsed low when a key is pressed. The row output latches are open-collector, therefore, pulses can not be seen until the circuit is completed by pressing a key. The keyboard connects directly to the controller at A3J3.

The display is driven by the controller through data latches on the A3 assembly. The display control lines are eight bi-directional data lines, an enable clock line, a read/write line, and a data/instruction line. The other lines going to the display are the display +5 V and ground. The enable clock line is high during every data interchange. The read/write line is high for a read operation and low for a write operation. The data/instruction line is high for a data operation and low for an instruction operation. The data/instruction line is used only during write operations. Data refers to the character data while instruction refers to commands, such as return or space. When interchanging data, the controller polls the display for acknowledgment. This means that if the display is disconnected the

controller will cease to attempt operations.

Table 5-1. A1 Front Panel (Keyboard)

	Col 1 A3J3-1	Col 2 A3J3-2	Col 3 A3J3-3	Col 4 A3J3-4	Col 5 A3J3-5	Col 6 A3J3-6	Col 7 A3J3-7
Row 1 A3J3-9	← (freq)	FREQUENCY	INCR SET	7	8	9	MHz dB(m)
Row 2 A3J3-10	⇒ (freq)	AMPLITUDE	↑	4	5	6	kHz mV
Row 3 A3J3-11	REF SET (freq)	FM	↓	1	2	3	% mV
Row 4 A3J3-12	REF ON/OFF (freq)	AM	ΦM	0	.	±	rad dB _μ V
Row 5 A3J3-13	ADRS	SAV	REG	↑ (memory)	MOD ON/OFF	INT 400 Hζ	EXT AC
Row 6 A3J3-14	LOCAL	DEL	SEQ	? (memory)	1 kHz + EXT DC	INT 1 kHz	EXT DC
Row 7 A3J3-15	← (ampl)	⇒ (ampl)	REF SET (ampl)	REF ON/OFF (ampl)	RF ON/OFF	ATTN HOLD	
Row 8 A3J3-16	← (back space)	mV emf	μV emf	dB _μ V emf			

A2 Power Supply

The power supply is a switching power supply producing 4 voltages; +5 V, +15 V, -15 V, and +38 V. The switching supply will only regulate when connected to a load. The power supply receives mains (line) voltage through the power switch on the front panel and the line module on the rear panel. Post regulation on the A3 assembly produces ± 12 V, filtered +5 V, +5 V, +24 V and +8 V. The +24 V and +8 V are used only in the 8648B/C/D.

A3 Motherboard

The motherboard contains four functional blocks: modulation distribution, controller, post regulation, and diagnostic latching.

The modulation distribution block produces two level-calibrated modulation frequencies, 1 kHz and 400 Hz. The frequencies are derived by dividing a 200 kHz signal from the A4 reference module by 200 and 500. The internal signals are leveled by an amplifier and a 12-bit DAC. When FM is enabled, it is routed to the A5 sig gen synth module. When AM is enabled, it is routed to the A6 output module when the RF output frequency is ≤ 1000 MHz. When the RF output is > 1000 MHz, the AM signal is routed to the A10 frequency extension module.

When internal modulation is turned on, the signal is also routed to the front panel MOD INPUT/OUTPUT connector. External signals are also routed through the modulation distribution block. External signals can be either ac- or dc-coupled. The modulation signals can be checked at A3J31-4 for the FM signal, while the AM signal is available at A3J31-1 (RF ≤ 1000 MHz) or A3J31-3 (RF > 1000 MHz).

The controller contains the microprocessor, memory, serial I/O for the other assemblies, GPIB, front panel control, and serial interface for the external control options. Memory is broken into four sections; EEPROMs, ROM, volatile SRAM and non-volatile battery-backed SRAM. The ROMs are contained on a separate memory board, A3A1.

The power supply provides ± 15 V, +5 V, and +38 V to the motherboard. The post regulation circuitry contains regulators for +12 V, -12 V, +5 V (shown as +5 V(F1), +24 V, and +8 V. There is additional circuitry to derive a filtered +5 V from the power supply for the digital circuitry. The +12 V, +8 V, and +5 V regulators are driven by the +15 V supply from the A2 assembly. The -12 V regulator is driven by the -15 V supply and the +24 V regulator is driven by the +38 V supply. There are indication LEDs on the motherboard for the +38 V, ≤ 12 V, +5 V, and +5 V(F1) power supplies.

The diagnostic latches latch signals from around the instrument that are read by the controller during power-up.

The motherboard contains calibration EEPROM that is specific to this instrument. If the A3 assembly is replaced, information specific to that 8648 must be downloaded to the calibration EEPROM and then the calibration data must be regenerated. Refer to “Motherboard Repair Utility” in Chapter 7 for information on the using the Agilent Service Support Software to download the instrument information to the EEPROM. See Chapter 7 to regenerate the calibration data using the adjustments.

A4 Reference

The reference assembly accepts either an external 10 MHz reference signal to lock the internal 10 MHz TCXO (temperature-compensated crystal oscillator) or uses an optional high stability 10 MHz OCXO (oven-controlled crystal oscillator). The reference assembly outputs two 200 kHz signals, a 1 GHz signal, and a 10 MHz signal which is routed to the rear panel.

One of the two 200 kHz signals is routed to the A5 synthesizer and the other to the A3 modulation section. The 1 GHz signal is routed to the A6 output assembly.

The 10 MHz REF OUTPUT rear panel signal is a buffered output from the 10 MHz TCXO or OCXO.

The 200 kHz signals are derived by dividing the 10 MHz signal by 50. The 1 GHz signal is derived from a 1 GHz VCO that is phase-locked to the 10 MHz signal.

The reference assembly contains a calibration ROM that contains factory-generated calibration data that is specific to the assembly.

A5 Sig Gen Synth

The synthesizer assembly uses a 200 kHz reference signal from the A4 reference assembly and generates a 500 to 1000 MHz signal using a divide-by-n phase-locked loop VCO. Frequency and phase modulation are also done in the synthesizer assembly. The frequency is modulated both inside and outside of the loop bandwidth. FM outside of the loop bandwidth is summed with the integrator error voltage and applied directly to the VCO. FM within the loop bandwidth and phase modulation signals are applied to a phase modulator along with the signal from the divide-by-n circuitry and then applied to the phase detector.

The synthesizer assembly contains a calibration ROM that contains factory-generated calibration data that is specific to the assembly.

A6 Output (8648A)

The output assembly takes the 500 to 1000 MHz signal from the A5 assembly and the 1 GHz LO signal from the A4 assembly to generate the output frequency range of 0.1 to 1000 MHz in three bands. The output assembly also handles the filtering, AM, and amplitude leveling functions.

The three frequency bands range from 0.1 to 249 MHz, 249 to 501 MHz and 501 to 1000 MHz. The 0.1 to 250 MHz band is heterodyned from the 1 GHz LO signal and the 500 to 1000 MHz main band signal. The 250 to 500 MHz signal is derived by dividing the 500 to 1000 MHz main band signal by two.

Filtering is handled by separate low-pass filters for each frequency band. AM is done using two separate modulators, one for the divide band and one dual-output modulator for the main and heterodyne bands. The AM signal from the A3 modulation section for both modulators is summed into the ALC loop integrator.

Amplitude leveling is handled with an ALC loop to lock the level and an amplitude DAC to set the level. The error signal from the ALC integrator is sent to either of the two modulators along with the summed AM signal.

The output assembly contains a calibration EEROM that contains calibration data. This data must be regenerated anytime an A6 assembly is replaced.

A6 Output (8648B/C/D)

The A6 output module works in conjunction with the A10 frequency extension module and differs from 8648A operation in the following ways:

1. AM is input to the output module only for frequencies ≤ 1000 MHz. For higher frequencies, this signal goes to the A10 frequency extension module.
2. The ALC detector voltage for all frequencies (not just > 1000 MHz) is now generated on the A10 frequency extension module.
3. The range of the RF input to mixer in the a6 Output has been changed to allow the mixer to output signals between 9 kHz and 249 MHz to the a10 frequency extension assembly.

A7 Attenuator (8648A)

The attenuator assembly contains the attenuators, the reverse-power-protection circuitry and the temperature-sense circuitry.

The attenuator assembly contains a calibration EEROM that contains calibration data. This data must be regenerated anytime the A7 assembly is replaced.

A10 Frequency Extension (8648B/C/D)

The main input to the A10 frequency extension module is the 9 kHz to 1000 MHz RF from the A6 output module. It operates in three frequency bands to cover the extended frequency range of the 8648B/C/D:

- 9 kHz to 1000 MHz
- > 1000 MHz to 2000 MHz
- > 2000 to 4000 MHz

For frequencies ≤ 1000 MHz, the module operates as an amplifier and provides a dc voltage to the A6 output module that is used for ALC. This dc voltage represents the detected RF output level from the module and is used as an input to the ALC integrator on the A6 module. For RF output frequencies between 1000 and 2000 MHz, a doubler is used on the 500 to 1000 MHz input signal. Three bandpass filters are used over this frequency range to control harmonics. A pre-level detector provides a dc voltage to the A6 output module that is used to drive the ALC loop integrator on the A6 output module. An additional ALC loop is provided on this module for frequencies > 1000 MHz.

For RF output frequencies between 2000 and 4000 MHz an additional doubler is used. For this frequency range, the signal from the A6 output module is between 500 and 1000 MHz. ALC operation is the same as for the 1000 to 2000 MHz band.

The A10 assembly contains a calibration EEROM that contains calibration data. This data must be regenerated anytime the A10 assembly is replaced.

A11 Attenuator (8648B/C/D)

The attenuator is a 4-section attenuator (10, 20, 30, and 60 dB sections) that provides 130 dB attenuation in 10 dB steps.

Calibration EEROM on the motherboard contains calibration data specific to this assembly. It needs to be updated whenever the attenuator is replaced.

A12 Reverse Power Protection(8648B/C/D)

The reverse power protection assembly is designed to protect the instrument from power applied to the RF output from an external source. It opens the RF path when an excessive power level is detected. When it is tripped the front panel indicates that RF power is off. To reset the RPP assembly, just turn the RF power on again.

Calibration EEROM on the motherboard contains calibration data specific to this assembly. It needs to be updated whenever the RPP assembly is replaced.

A13 Pulse Modulator (8648B/C/D Option 1E6)

The pulse modulation module is a thick film circuit mounted inside the instrument. The main inputs are:

- RF output from the A10 frequency extension module
- TTL pulse from the rear-panel PULSE IN connector

The module is supplied with -15V , $+5\text{V}$, GND, data and enable lines, from the A3 motherboard assembly via a twisted wire assembly. If Option 1E2 is present, the power and lines are routed from the motherboard via the A14 modulation generator assembly.

A14 Modulation Generator (Option 1E2)

The modulation generator contains the DSP (digital signal processor), memory, DAC, serial I/O for the other assemblies, and output filters. It generates sine, square, triangle, and saw (or ramp) waveforms used to modulate the AM, FM, and Φ M states of the instrument.

When the instrument is using the variable frequency/waveform source, the modulation generator will work as an internal modulation source connected to the MOD INPUT/OUTPUT port. The modulated signal can be monitored from the MOD INPUT/OUTPUT port as a 2 V_{p-p} signal.

This assembly has a serial communication port and communicates with the main controller on the A3 motherboard through this port. The calibration data for the modulation generator output level is stored in EEPROM on this assembly.

The modulation generator has its own crystal controlled oscillator.

The DAC output signal is filtered by a 50 kHz cut-off, low-pass filter.

A30 Pager Encoder (8648A Option 1EP)

The encoder contains the DSP (digital signal processor), memory, DAC, serial I/O for the other assemblies, timebase, and output filters. The pager encoder generates FLEX, FLEX-TD™, or POCSAG formatted 2-level or 4-level FSK signals. It also generates variable-frequency sine, square, triangle, and saw (or ramp) waveforms. When the instrument is either in the pager encoding settings state or using the variable frequency/waveform source, the encoder will work as an internal modulation source connected to the MOD INPUT/OUTPUT port. The modulated signal can be monitored from the MOD INPUT/OUTPUT port as a 2 V_{p-p} signal.

This assembly has a serial communication port and communicates with the main controller on the A3 motherboard through this port. The calibration data for the encoder output level is stored in EEPROM on this assembly.

The memory consists of EEPROM, SRAM, and flash memory. The flash memory stores the long pager message which will be generated by an external controller.

To achieve precise timing accuracy for pager protocol, the encoder has its own timebase unit (TCXO).

The DAC output signal is filtered by either the 10th order Bessel low-pass filter (–3 dB at 3.9 kHz) or a 50 kHz cut-off, low-pass filter.

5b Troubleshooting Information

This chapter is intended to be used in conjunction with the information in chapters 5a, 5c, and with your own troubleshooting style. The troubleshooting reference information should contain the details needed as you follow your troubleshooting process.

This chapter contains the following troubleshooting reference information:

- **Troubleshooting checklist**
Use the troubleshooting checklist as a reminder of things to check.
- **AC Mains (Line)Fuse Removal**
Use these instructions to replace the AC mains fuse.
- **Modulation Test Points and Power Supply LEDs Diagram**
Use the diagram to check for the proper modulation reading and for a quick visual check that the power supply voltages are present.
- **Power Supply Distribution Diagram**
Use the diagram to identify the correct power supply voltage distribution.
- **Instrument Block Diagrams**
There are three instrument block diagrams: one for the 8648A, one for the 8648B/C, and one for the 8648D. The block diagrams contain pin and connector designations as well as input/output specifications.

See Chapter 5a, “Theory of Operation,” for the block diagram description.

Troubleshooting Checklist

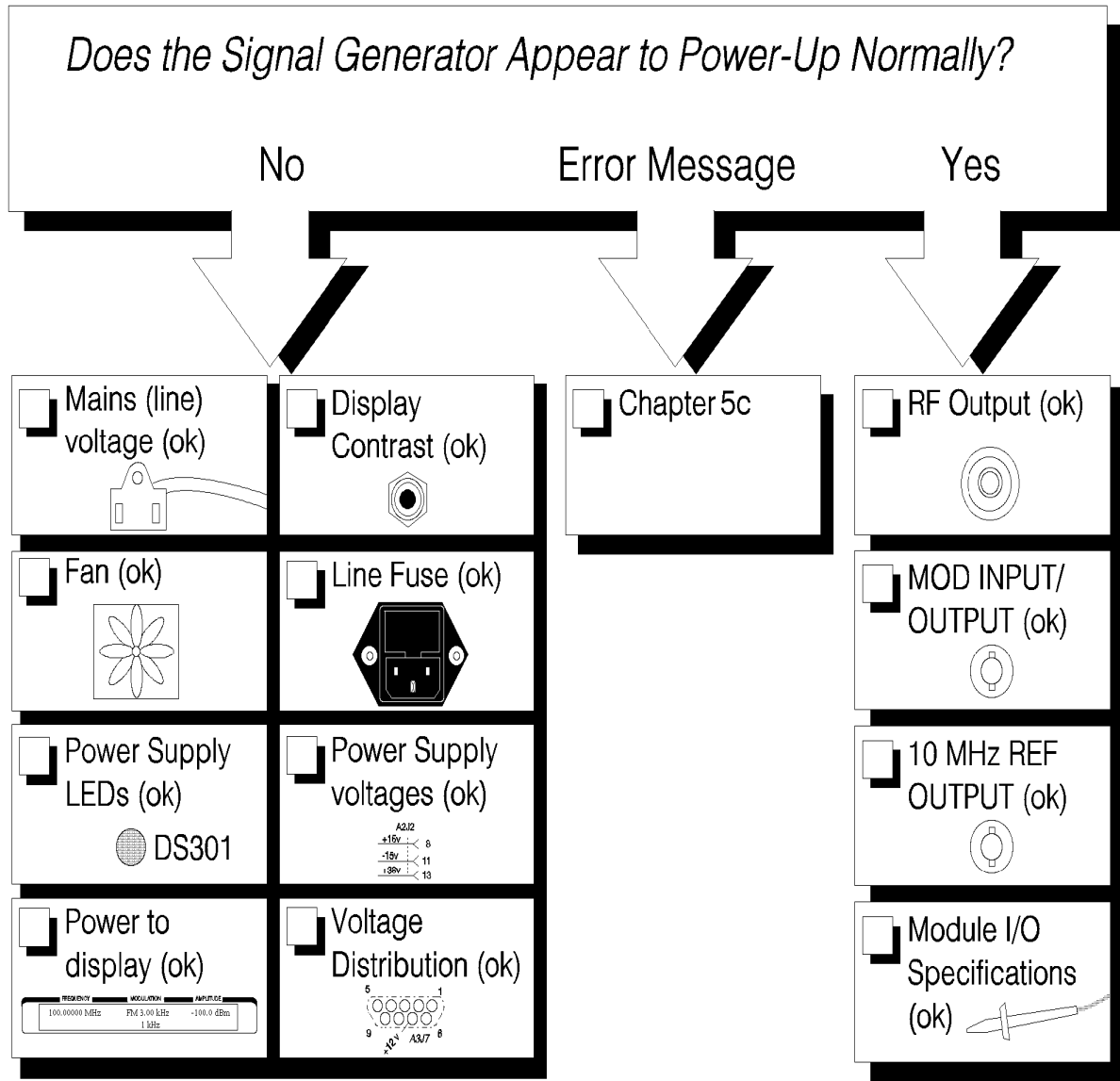

chklist_c.tif

AC Mains (Line) Fuse Removal

To Remove the Fuse

1. Unplug the power cord from the mains (line) module.
2. Use a flat-bladed screw driver (Figure 5b-1) to pry loose and unseat the fuse housing from the line module.
3. Remove the cartridge and inspect the fuse nearest the front of the instrument.

Figure 5b-1. Fuse Removal

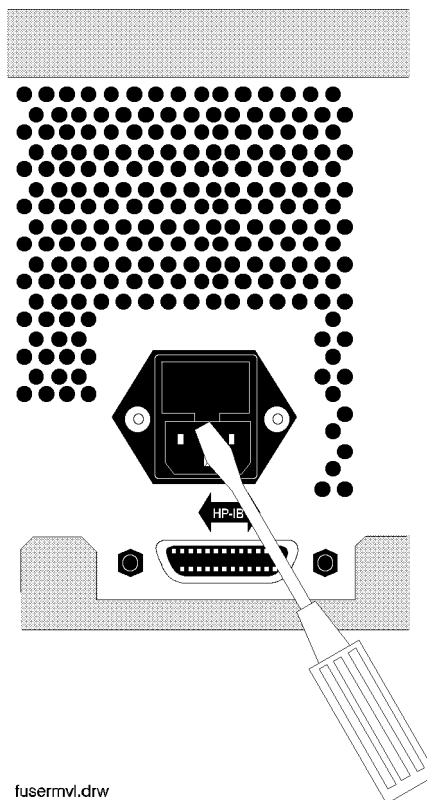

Modulation Test Points and Power Supply LEDs

Figure 5b-2. Location Diagram

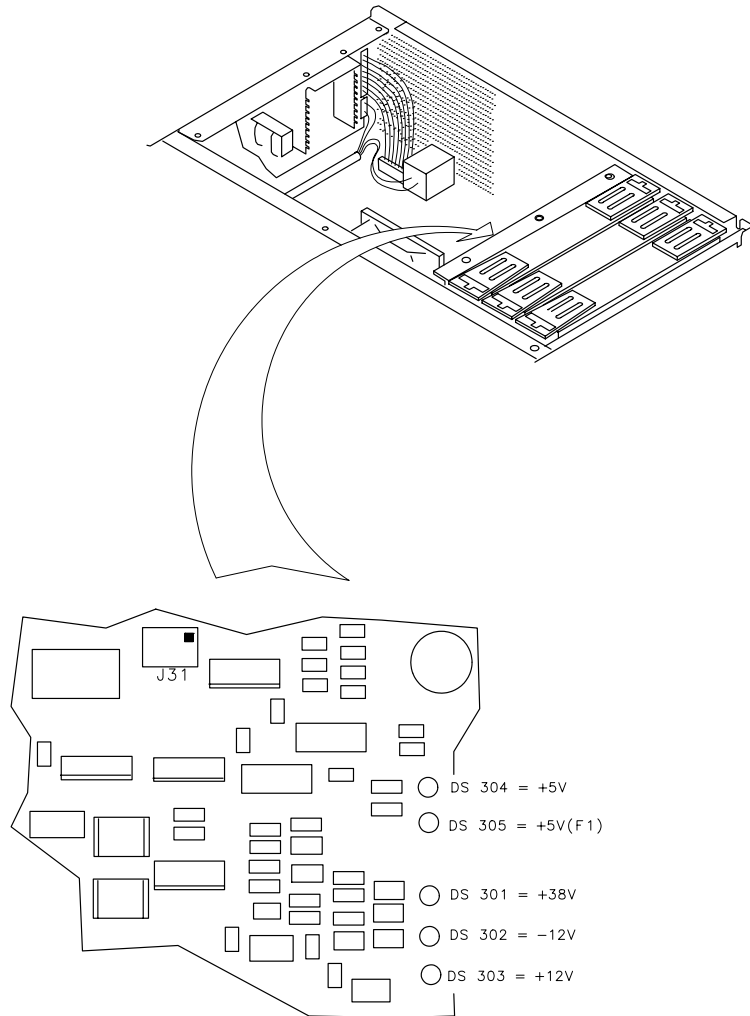

sn612a

Power Supply Distribution

Figure 5b-3. Bottom View of Motherboard with Cover Removed

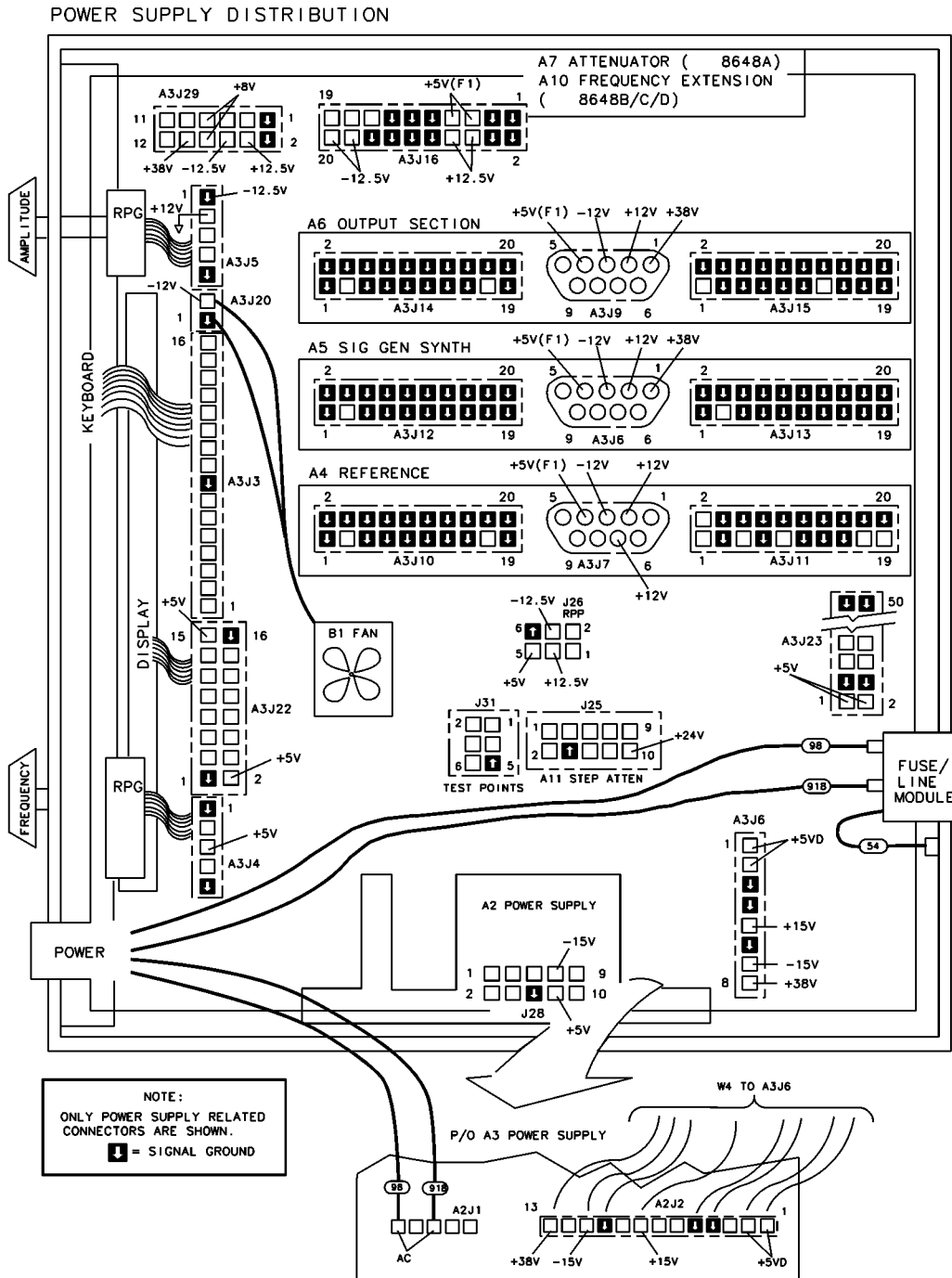

on66a2d

8648A BLOCK DIAGRAM

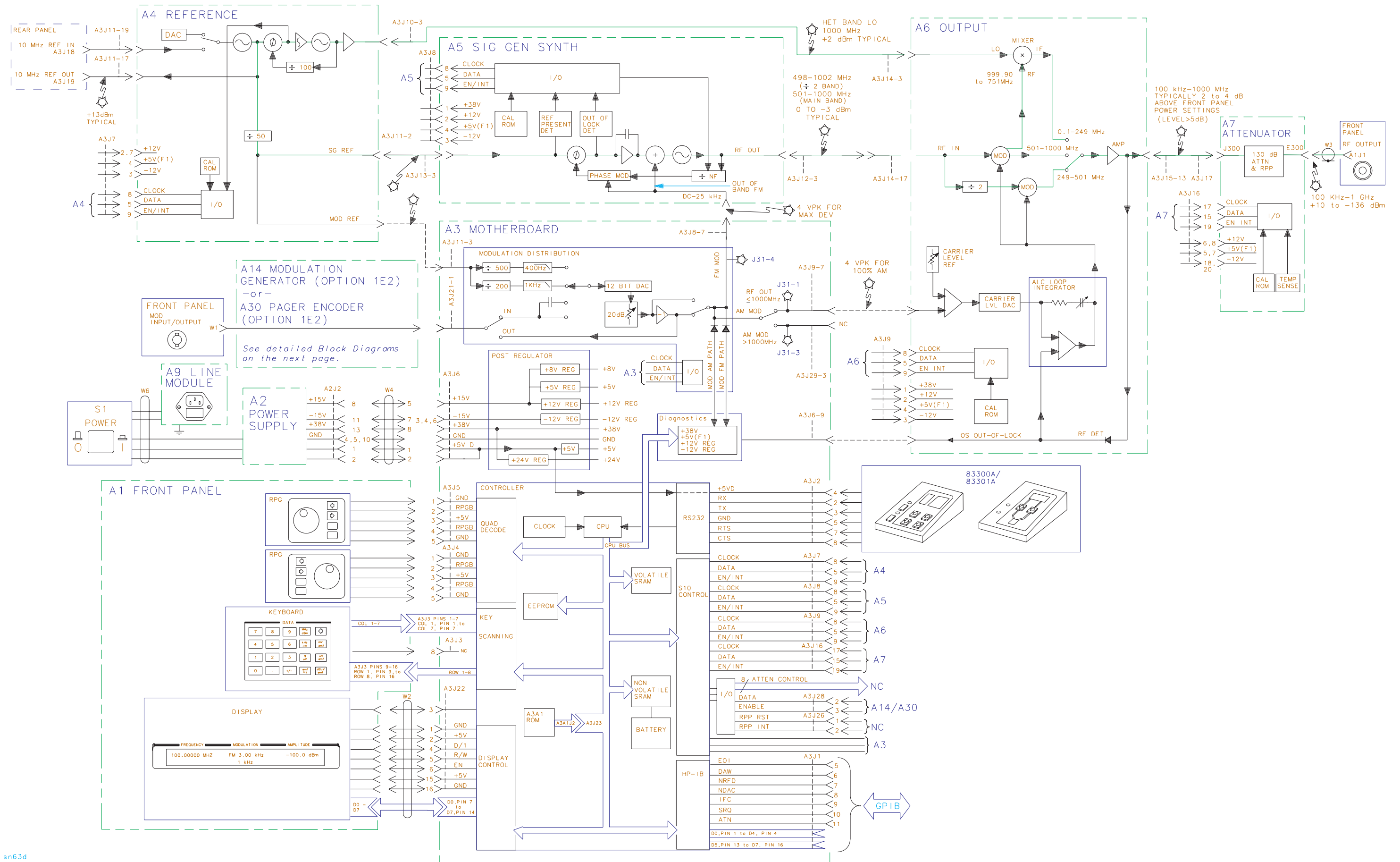
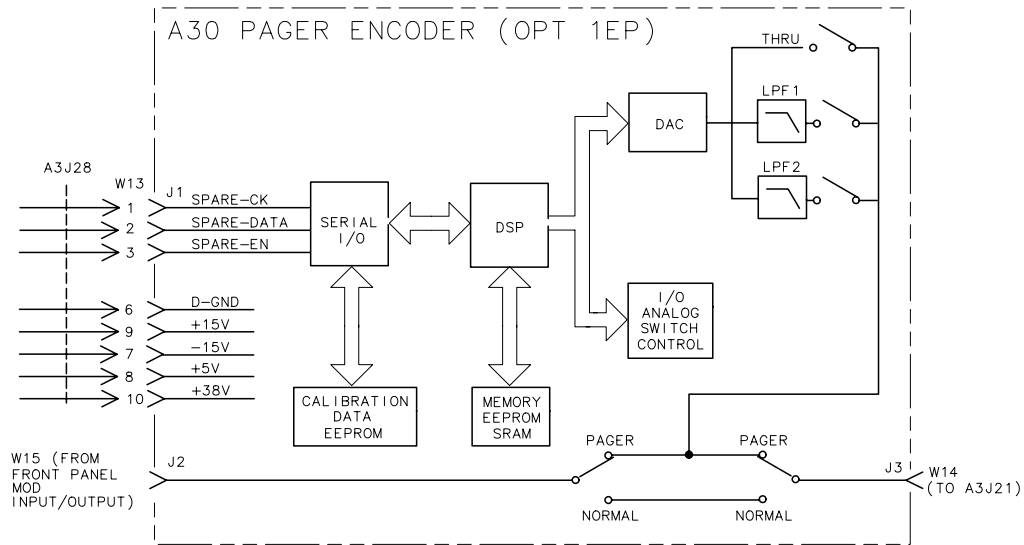
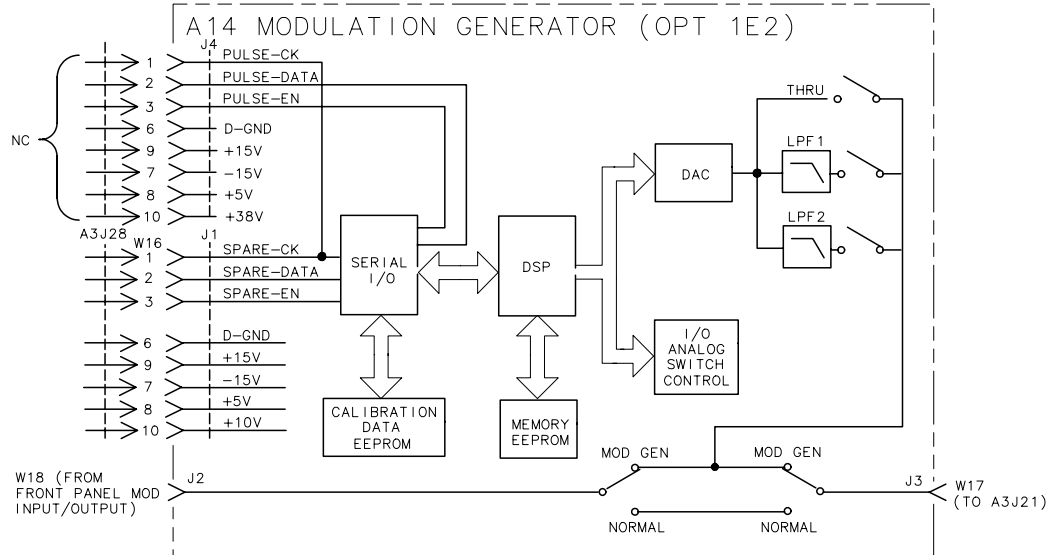

Figure 5b-5. 8648A Option 1EP A30 Pager Encoder Block Diagram



on623a2d

Figure 5b-6. 8648A Option 1E2 A14 Modulation Generator Block Diagram



on622a2d

8648B/C/D BLOCK DIAGRAM
SHEET 1 OF 2

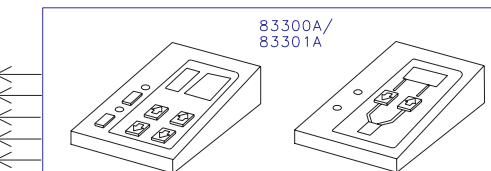
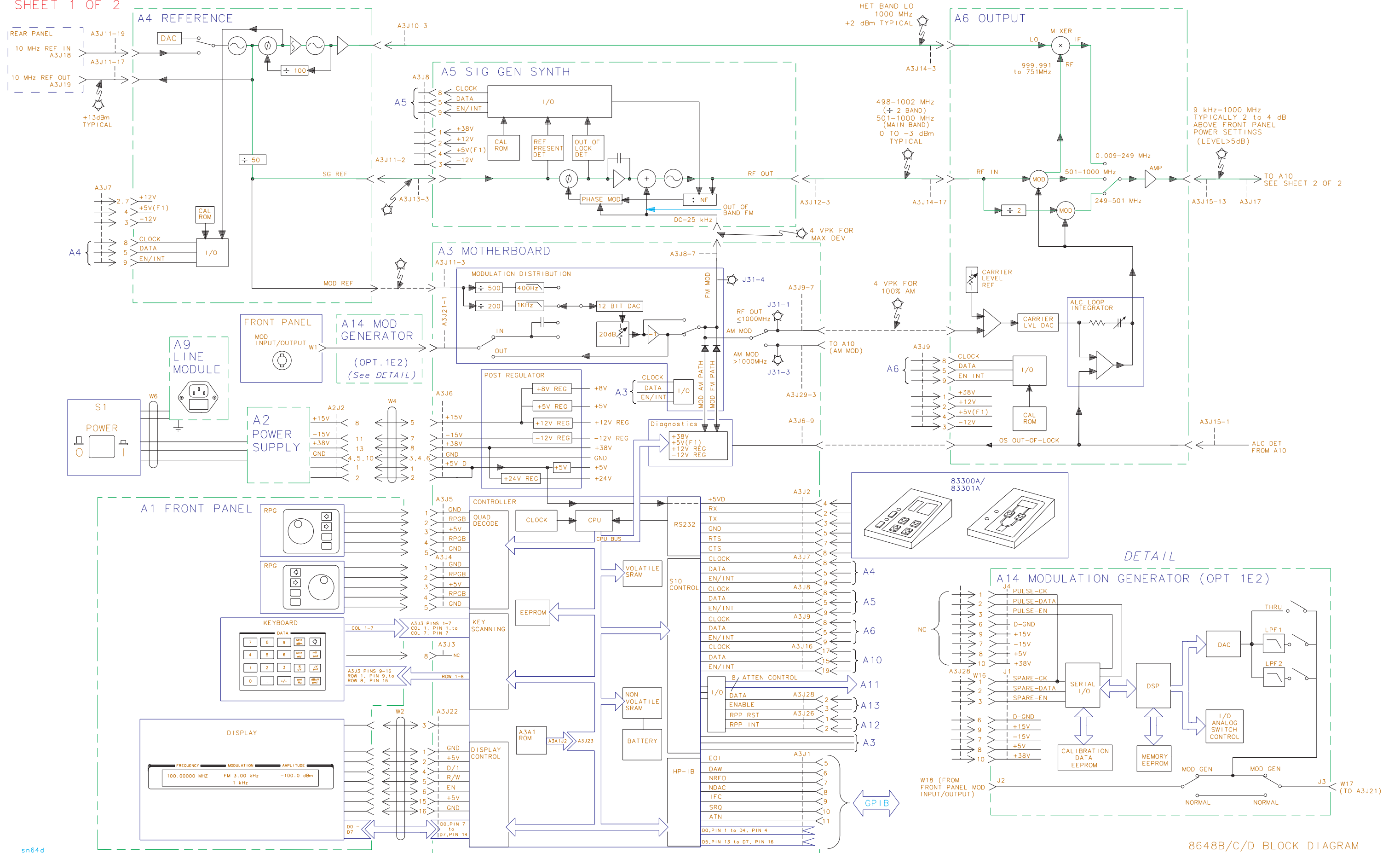

DETAIL

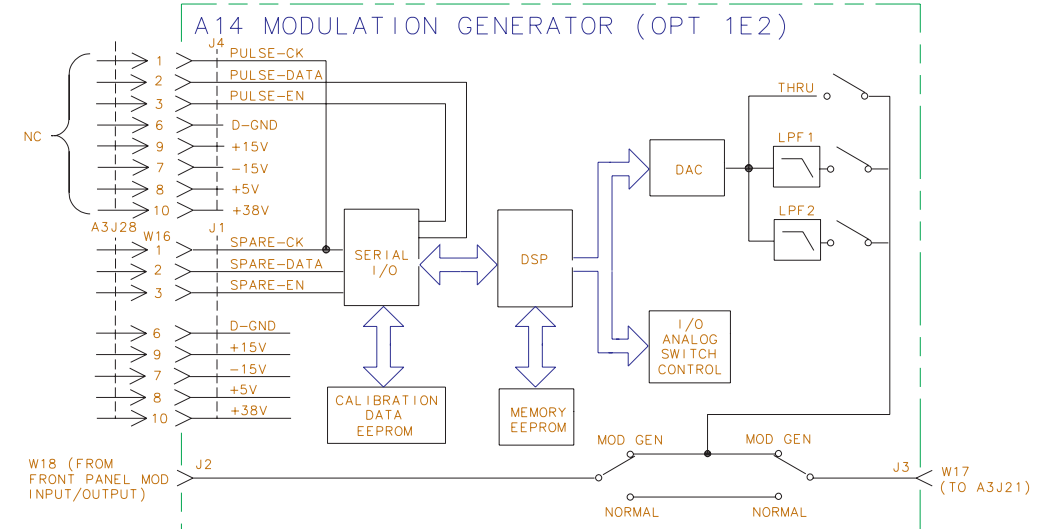

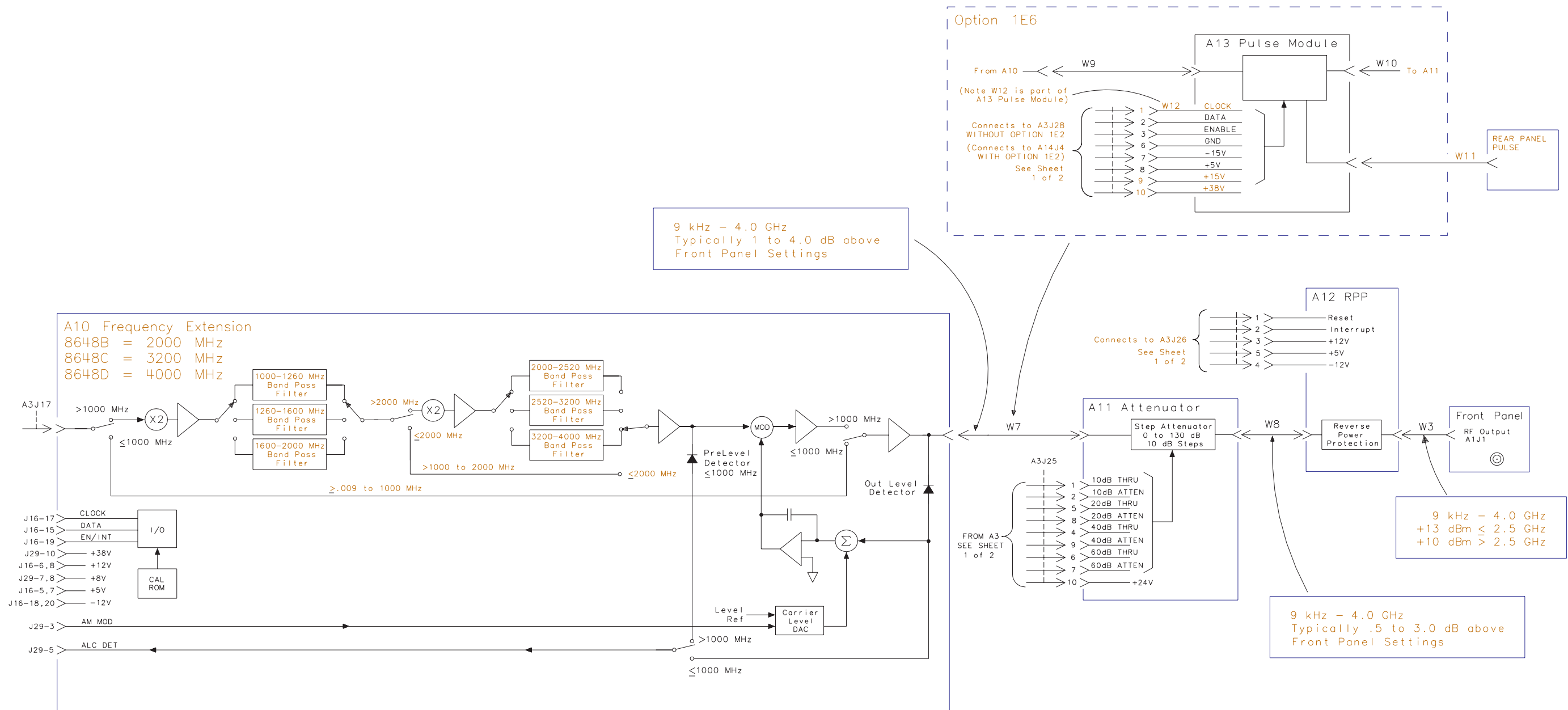

5c Service Error Messages

This chapter describes service error messages. Front panel and GPIB operation messages are covered in Chapter 1c, “Operation Messages”.

502 Updated cal file

Description The RAM calibration file has been updated from the calibration ROM.

Cause This is normal when a module is replaced.

What To Do This message requires no action.

503 Cal corrupt: restored

Description After detecting a failure in comparing calibration data between RAM and the calibration ROM, a data restore was done.

What To Do This message requires no action.

504 Modulation cal restore failure

Description After detecting a failure comparing calibration data between RAM and the calibration ROM, a data restore was attempted unsuccessfully.

Cause There is either a failure in writing data to RAM or in reading data from the calibration ROM.

What To Do Replace the A3 assembly. Both the calibration ROM and RAM are on the A3 assembly.

505 FM sense cal restore failure

Description After detecting a failure in comparing calibration data between RAM and the calibration ROM, a data restore was attempted unsuccessfully.

Cause There is either a failure in writing data to RAM or in reading data from the calibration ROM.

What To Do The calibration ROM can be verified by replacing the A5 assembly. The calibration ROM is contained in the assembly.

If the failure is still present after replacing the A5 assembly, replace the A3 assembly, which contains the RAM.

506	FM mult cal restore failure
Description	After detecting a failure in comparing calibration data between RAM and the calibration ROM, a data restore was attempted unsuccessfully.
Cause	There is either a failure in writing data to RAM or in reading data from the calibration ROM.
What To Do	The calibration ROM can be verified by replacing the A5 assembly. The calibration ROM is contained in the assembly. If the failure is still present after replacing the A5 assembly, replace the A3 assembly, which contains the RAM.
507	Output level cal restore failure
Description	After detecting a failure in comparing calibration data between RAM and the calibration ROM, a data restore was attempted unsuccessfully.
Cause	There is either a failure in writing data to RAM or in reading data from the calibration ROM.
What To Do	The calibration ROM can be verified by replacing the A6 assembly. The calibration ROM is contained in the assembly. If the failure is still present after replacing the A6 assembly, replace the A3 assembly, which contains the RAM.
508	Attenuator cal restore failure
Description	After detecting a failure in comparing calibration data between RAM and the calibration ROM, a data restore was attempted unsuccessfully.
Cause	There is either a failure in writing data to RAM or in reading data from the calibration ROM.
What To Do	The calibration ROM can be verified by replacing the A6 assembly. The calibration ROM is contained in the assembly. If the failure is still present after replacing the A6 assembly, replace the A3 assembly, which contains the RAM.
509	Timebase cal restore failure
Description	After detecting a failure in comparing calibration data between RAM and the calibration ROM, a data restore was attempted unsuccessfully.
Cause	There is either a failure in writing data to RAM or in reading data from the calibration ROM.
What To Do	The calibration ROM can be verified by replacing the A4 assembly. The calibration ROM is contained in the module. If the failure is still present after replacing the A4 assembly, replace the A3 assembly, which contains the RAM.

510	Temperature cal restore failure
Description	After detecting a failure in comparing calibration data between RAM and the calibration ROM, a data restore was attempted unsuccessfully.
Cause	There is either a failure in writing data to RAM or in restoring data from the calibration ROM.
What To Do	The calibration ROM can be verified by replacing the A7 assembly. The calibration ROM is contained in the module. If the failure is still present after replacing the A7 assembly, replace the A3 assembly, which contains the RAM.
511	TF coeff's cal restore failure
Description	After detecting a failure in comparing calibration data between RAM and the calibration ROM, a data restore was attempted unsuccessfully.
Cause	There is either a failure in writing data to RAM or in reading data from the calibration ROM.
What To Do	The calibration ROM can be verified by replacing the A7 assembly. The calibration ROM is contained in the assembly. If the failure is still present after replacing the A7 assembly, replace the a3 assembly, which contains the RAM.
512	Generic path cal restore failure
Description	After detecting a failure in comparing calibration data between RAM and the calibration ROM, a data restore was attempted unsuccessfully.
Cause	There is either a failure in writing data to RAM or in reading data from the calibration ROM.
What To Do	Replace the A3 assembly. The A3 assembly has a continuity failure. The calibration ROM is on the A3 assembly with the RAM.
513	Output tune cal restore failure
Description	After detecting a failure in comparing calibration data between RAM and the calibration ROM, a data restore was attempted unsuccessfully.
Cause	There is either a failure in writing data to RAM or in reading data from the calibration ROM.
What To Do	The calibration ROM can be verified by replacing the A6 assembly. The calibration ROM is contained in the assembly. If the failure is still present after replacing the A6 assembly, replace the A3 assembly, which contains the RAM.

515	Freq Ext level cal restore failure
Description	After detecting a failure in comparing calibration data between RAM and the calibration ROM, a data restore was attempted unsuccessfully.
Cause	There is either a failure in writing data to RAM or in reading data from the calibration ROM.
What To Do	The calibration ROM can be verified by replacing the A10 (freq ext) assembly. The calibration ROM is contained in the assembly. If the failure is still present after replacing the A10 assembly, replace the A3 assembly, which contains the RAM.
516	Config cal restore failure
Description	After detecting a failure in comparing calibration data between RAM and the calibration ROM, a data restore was attempted unsuccessfully.
Cause	There is either a failure in writing data to RAM or in reading data from the calibration ROM.
What To Do	Replace the A3 assembly. The A3 assembly has a continuity failure. The calibration ROM is on the A3 assembly with the RAM.
517	Output prelevel cal restore failure
Description	After detecting a failure in comparing calibration data between RAM and the calibration ROM, a data restore was attempted unsuccessfully.
Cause	There is either a failure in writing data to RAM or in reading data from the calibration ROM.
What To Do	The calibration ROM can be verified by replacing the A6 assembly. The calibration ROM is contained in the assembly. if the failure is still present after replacing the A6 assembly, replace the A3 assembly, which contains the RAM.
518	Atten comp loss cal restore failure
Description	After detecting a failure in comparing calibration data between RAM and the calibration ROM, a data restore was attempted unsuccessfully.
Cause	There is either a failure in writing data to RAM or in reading data from the calibration ROM.
What To Do	Replace the A3 assembly. The A3 assembly has a continuity failure. The calibration ROM is on the A3 assembly with the RAM.

601	-12 V power supply failure
Description	The -12 V diagnostic test point decreased by more than approximately 0.4 V.
Cause	Either the -12 V regulator on the A3 motherboard has failed, or the -15 V supply on the A2 power supply assembly has failed.
What To Do	Check the output of both the -15 V and -12 V supplies.
603	+12 V power supply failure
Description	The +12 V diagnostic test point decreased by more than approximately 0.4 V.
Cause	Either the +12 V regulator on the A3 motherboard has failed, or the +15 V supply on the A2 power supply assembly has failed.
What To Do	Check the output of both the +15 V and +12 V supplies.
604	+38 V power supply failure
Description	The +38 V diagnostic test point decreased by more than approximately 2.2 V.
Cause	The +38 V supply on the A2 power supply has failed.
What To Do	Check the +38 V supply.
605	ALC out-of-lock div het main band
Description	The ALC loop is out of lock in the indicated bands.
Cause	Either the A6 output has failed, or the signal from the A5 synthesizer has failed or the A4 reference has failed. If only the het band has failed it is possible that the A4 reference has failed.
What To Do	Check the input to the A6 output from the A5 synthesizer and the A4 reference.
608	Synth out-of-lock div het main band
Description	The synthesis loop is out of lock in the indicated bands.
Cause	Either the A5 synthesizer has failed, or the signal from the A4 reference has failed.
What To Do	Check the input to the A5 synthesizer from the A4 reference.

611	200 kHz reference missing at synth
Description	The A5 module indicates that the 200 kHz reference signal from the A4 module is not being detected.
Cause	Either the A4 module has failed to output the 200 kHz reference signal, or the A5 module is failing to detect the signal.
What To Do	Check the 200 kHz reference output of the A4 module at the input to the A5 module.
612	Reference out-of-lock at 10 MHz
Description	The A4 module indicates that the 10 MHz reference VCO is out-of-lock.
Cause	Either the A4 module has failed or a bad external reference is connected.
What To Do	Disconnect any external reference and power up the instrument again or replace the A4 module if the error is still present with no external reference.
613	Reference out-of-lock at 1 GHz
Description	The A4 module indicates that the 1 GHz reference is out-of-lock.
Cause	Either the A4 module has failed or a bad external reference is connected.
What To Do	Replace the A4 module.
614	400 Hz modulation source failed
Description	The A3 board indicates that the 400 Hz modulation source is not present.
Cause	Either the 200 kHz reference signal from the A4 module has failed, or the A3 has failed.
What To Do	Check the 200 kHz reference output of the A4 module at the input to the A3 board.
615	1 kHz modulation source failed
Description	The A3 board indicates that the 1 kHz modulation source is not present.
Cause	Either the 200 kHz reference signal from the A4 modulation source has failed, or the A3 board has failed. However, if the 400 Hz modulation source has already been tested, the failure is most likely the A3 board.
What To Do	Replace the A3 board.

616	AM modulation path failure
Description	The AM path detector indicates a failure at the output of the A3 board.
Cause	Either the signal output has failed, or the detector has failed.
What To Do	Replace the A3 board.
617	FM modulation path failure
Description	The FM path detector indicates a failure at the output of the A3 board.
Cause	Either the signal output has failed, or the detector has failed.
What To Do	Replace the A3 board.
618	PM modulation path failure
Description	The PM path detector indicates a failure at the output of the A3 board.
Cause	Either the signal output has failed, or the detector has failed.
What To Do	Replace the A3 board.
619	modulation 20 dB step failure
Description	The 20 dB step attenuator has failed.
Cause	The A3 board has failed.
What To Do	Replace the A3 board.
620	Comm failure:
Description	A serial communication failure has occurred with the indicated assemblies.
Cause	Either the A3 controller has failed or the indicated assembly has failed.
What To Do	If one assembly has failed, check the indicated assembly. If multiple failures have occurred, check the controller first. In either case, both the controller and the assembly should be checked.
625	ROM checksum failure
Description	The A3 controller has detected a mismatch in reading data from ROM.
Cause	Either the controller has failed in reading from ROM, or the ROM data has failed.
What To Do	Check the hardware connection between the motherboard and the ROM board.

626	Volatile RAM read/write failure
Description	The controller detected a failure when comparing data that was written to, and then read from volatile RAM.
Cause	This is a hardware failure between points on the A3 board.
What To Do	The A3 board failure should be verified and the board replaced.
627	Battery RAM failure: memory lost
Description	The battery-backed RAM lost data.
Cause	Either the RAM has failed, the battery is bad, or the DEL key was held down at power up.
What To Do	Check the battery voltage and replace it if it is incorrect.
628	Non-volatile RAM read/write failure
Description	The controller detected a failure when comparing data that was written to, and then from non-volatile RAM.
Cause	This is a hardware failure between points on the A3 board.
What To Do	The A3 board failure should be verified and the board replaced.
629	dsp board failure:
Description	The dsp board self test has failed.
Cause	Either the dsp board (attached to the display) or the A3 controller has failed.
What To Do	Check the dsp board first for problems. If the dsp board is normal, check the A3 controller.

6 Replaceable Parts

To order parts, contact Agilent Technologies. A list of the Agilent Technologies offices is located at the front of this book. In the U.S.A., it is also possible to call 800-227-8164 and they will take your parts order. If you need help finding the correct part number, you can call Parts Identification at 916-783-0804 in the U.S.A.

Assembly Replacements

For most parts, you can either order a new assembly or an exchange assembly. Exchange assemblies are factory repaired, inspected, and tested. If you order an exchange assembly you must return the defective assembly part.

NOTE After the removal or replacement of assemblies, it may be necessary to perform related adjustments and performance test procedures prior to calibrating the signal generator.

For more information, refer to “Post Repair,” located in Chapter 5 of this manual. This section provides tables describing the assemblies and their related procedures.

Table 6-1. 8648A Replaceable Parts

Item	Part Number	Qty.	Description
A1		1	FRONT FRAME ASSY (NOT AVAILABLE FOR REPLACEMENT)
A1A1	0960-0856	1	RPG
A1A2	0960-0856	1	RPG
A1A3	08648-60178	1	FLEX CIRCUIT
A1A4	2090-0362	1	DISPLAY VFD 2x40 (Serial prefixes \geq 3836A/3836U)
	2090-0312	1	DISPLAY LCD 2x40 (Serial prefixes $<$ 3836A/3836U)
A1J1	1250-1811	1	RF OUTPUT TYPE-N CONNECTOR
A1MP1	08648-60188	1	FRONT FRAME KIT, 8648A/1E2 (Serial prefixes \geq 3836A/3836U)
	08648-60187	1	FRONT FRAME KIT, 8648A/1EP (Serial prefixes \geq 3836A/3836U)
	08648-60015	1	FRONT FRAME KIT, 8648A Options 1E2/1EP (Serial prefixes $<$ 3836A/3836U)
A1MP2	08647-40006	1	KEYPAD
A1MP3	08647-00004	1	DISPLAY MOUNT
A1MP4	08647-00019	1	COVER DISPLAY
A1MP5	01650-47401	1	KNOB-CURSOR
A1MP6	01650-47401	1	KNOB-CURSOR
	08648-80001	1	NAME PLACE 8648A
A2	0950-2293	1	POWER SUPPLY
A3	08648-60614	1	MOTHERBOARD ASSY (Serial prefixes \geq 3836A/3836U)
	08648-60314	1	MOTHERBOARD ASSY (Serial prefixes $<$ 3836A/3836U)
	08648-69614	1	EXCHANGE MOTHERBOARD KIT (Serial prefixes \geq 3836A/3836U)
	08648-69314	1	EXCHANGE MOTHERBOARD KIT (Serial prefixes $<$ 3836A/3836U)
A3A1	08648-60146	1	MEMORY BOARD (FIRMWARE KIT)
A3A1	08648-60165	1	MEMORY BOARD OPTION 1EP (FIRMWARE KIT)
A3BT1	1420-0338	1	BATTERY 3.0V 1.2AH
A3J1	1252-2161	1	CONNECTOR RECT24F
A3J2	1252-1487	1	CONNECTOR RECT 9 F RA
A3J18	1250-1842	1	10 MHZ INPUT BNC
A3J19	1250-1842	1	10 MHZ OUTPUT BNC
A3R6	2100-4507	1	CONTRAST POTENTIOMETER (Serial prefixes $<$ 3836A/3836U)
A3S1	3101-2264	1	TIMEBASE ADJ SWITCH
A4	08647-61045	1	STANDARD REFERENCE ASSEMBLY

Table 6-1. 8648A Replaceable Parts

Item	Part Number	Qty.	Description
	08647-69045	1	STANDARD EXCHANGE REFERENCE ASSEMBLY
	08920-40009	2	CAM LEVERS (P/O A4)
	08920-40016	2	LEVER LOCKS (P/O A4)
A4	08648-60042	1	OPTION 1E5 HIGH STABILITY REFERENCE ASSEMBLY
	08648-69042	1	EXCHANGE OPTION 1E5 HIGH STABILITY REFERENCE ASSEMBLY
	08920-40009	2	CAM LEVERS (P/O A4)
	08920-40016	2	LEVER LOCKS (P/O A4)
A5	08648-60115	1	SIG GEN SYNTH ASSEMBLY
	08648-69115	1	EXCHANGE SIG GEN SYNTH ASSEMBLY
	08920-40009	2	CAM LEVERS (P/O A5)
	08920-40016	2	LEVER LOCKS (P/O A5)
A5	08648-60124	1	SIG GEN SYNTH ASSEMBLY (OPTION 1EP)
	08648-69124	1	EXCHANGE SIG GEN SYNTH ASSEMBLY (OPTION 1EP)
	08920-40009	2	CAM LEVERS (P/O A5)
	08920-40016	2	LEVER LOCKS (P/O A5)
A6	08647-61032	1	OUTPUT ASSEMBLY (Serial prefixes ≤ 3836A/3836U)
	08648-60186	1	OUTPUT ASSEMBLY (Serial prefixes ≥ 3847A/3847U)
	08647-69032	1	EXCHANGE OUTPUT ASSEMBLY KIT (Serial prefixes ≤ 3836A/3836U)
	08648-69186	1	EXCHANGE OUTPUT ASSEMBLY KIT (Serial prefixes ≥ 3847A/3847U)
	08920-40009	2	CAM LEVERS (P/O A6)
	08920-40016	2	LEVER LOCKS (P/O A6)
A7	08647-61803	1	1 GHZ ATTENUATOR KIT
	08647-69803	1	EXCHANGE ATTENUATOR KIT
A9	9135-0270	1	FILTERED LINE MODULE
	0361-1265	2	RIVETS (HOLDS A9 TO MP1)
A14	08648-60126	1	AUDIO GENERATOR BOARD ASSEMBLY (OPTION 1E2)
	08648-69126	1	EXCHANGE AUDIO GENERATOR BOARD ASSEMBLY (OPTION 1E2)
	08648-60374	1	AUDIO GENERATOR UPGRADE KIT (OPTION 1E2)
A30	08648-60030	1	PAGER ENCODER ASSEMBLY (OPTION 1EP)

Table 6-1. 8648A Replaceable Parts

Item	Part Number	Qty.	Description
	08648-69030	1	EXCHANGE PAGER ENCODER ASSEMBLY (OPTION 1EP)
B1	3160-0866	1	FAN TBAX
F1	2110-0780	1	FUSE 3 A 250 V (NOT SHOWN)
MP1	08647-61025	1	ASSEMBLY CHASSIS KIT (For serial prefixes < 3836A/3836U, also order 08647-61030)
MP2	08647-00026	1	COVER CARDBOX
MP3	08647-00030	1	COVER-MOTHERBOARD
MP4	08647-00031	1	COVER-RF
MP5	08647-00020	1	MOUNT-POWER SUPPLY
MP6	08648-00012	1	CLAMP (MEMORY BOARD BRACKET)
MP7			(NOT ASSIGNED)
MP8	08647-00028	1	COVER-INSTRUMENT
MP9	5041-3621	1	LINE SWITCH KEY CAP
MP10	5041-8801	4	FOOT FULL MOD
MP11	0515-2086	4	SCREW M4 x .07 7MM-LG 90- DEG-FLH-HD
MP12	0515-0372	22	SCREW MACH. M3 x 0.5 8MM-LG
MP13	0515-0380	35	SCREW MACH.M4 x 0.7 10MM-LG
MP14	0515-2243	4	SCREW MACH. M4.0 12SEMPAN TX
MP15	08647-40003	2	REAR FOOT HANDLE
MP16			(NOT ASSIGNED)
MP17			(NOT ASSIGNED)
MP18	0361-1341	4	RIVET NYL 3.9DIA (HOLDS B1 TO MP1)
MP19	2950-0054	2	NUT HEX 1/2 - 28
MP20	08648-00023	1	MOUNTING BRACKET FOR A30 (OPTION 1EP)
S1	3101-2216	1	LINE SWITCH
	0515-1940	2	SCREW MACH 2.5 6PCHPANTX (P/O S1)
W1	08647-61007	1	MODULATION CABLE
W2	08647-61011	1	DISPLAY CABLE
W3	08647-21022	1	RF OUTPUT CABLE (ATTENUATOR TO RF OUTPUT)
W4	08647-61005	1	POWER SUPPLY CABLE
W5			(NOT ASSIGNED)

Table 6-1. 8648A Replaceable Parts

Item	Part Number	Qty.	Description
W6	08647-61004	1	ASSEMBLY INCLUDES (LINE SWITCH, S1, AND WIRE HARNESS AND LINE MODULE, A9)
W13	8120-6792	1	CABLE ASSEMBLY (A30J1 TO A3J28) (OPTION 1EP)
W14	8120-6789	1	CABLE ASSEMBLY (A30J3 TO A3J21) (OPTION 1EP)
W15	8120-6788	1	CABLE ASSEMBLY (A30J2 TO MOD INPUT/OUTPUT) (OPTION 1EP)
W16	8120-6792	1	RIBBON CABLE ASSEMBLY, AUDIO BIAS (A14J1 TO A3J18) (OPTION 1E2)
W17	8120-6789	1	CABLE ASSEMBLY, AUDIO GEN (A14J3 TO A3J21) (OPTION 1E2)
W18	8120-6788	1	CABLE ASSEMBLY, FRONT PANEL AUDIO CABLE (A14J2 TO MOD INPUT/OUTPUT) (OPTION 1E2)
MISCELLANEOUS			
	5961-4720	1	TRANSIT CASE
	08648-10012	1	SERVICE SUPPORT SOFTWARE
	08648-60175	1	KIT TEST POINT EXTENDER
	08648-60180	1	SERVICE SOFTWARE KIT

Figure 6-3. 8648B/C/D Replaceable Parts - A11/A12/a13/A14 Detailed View

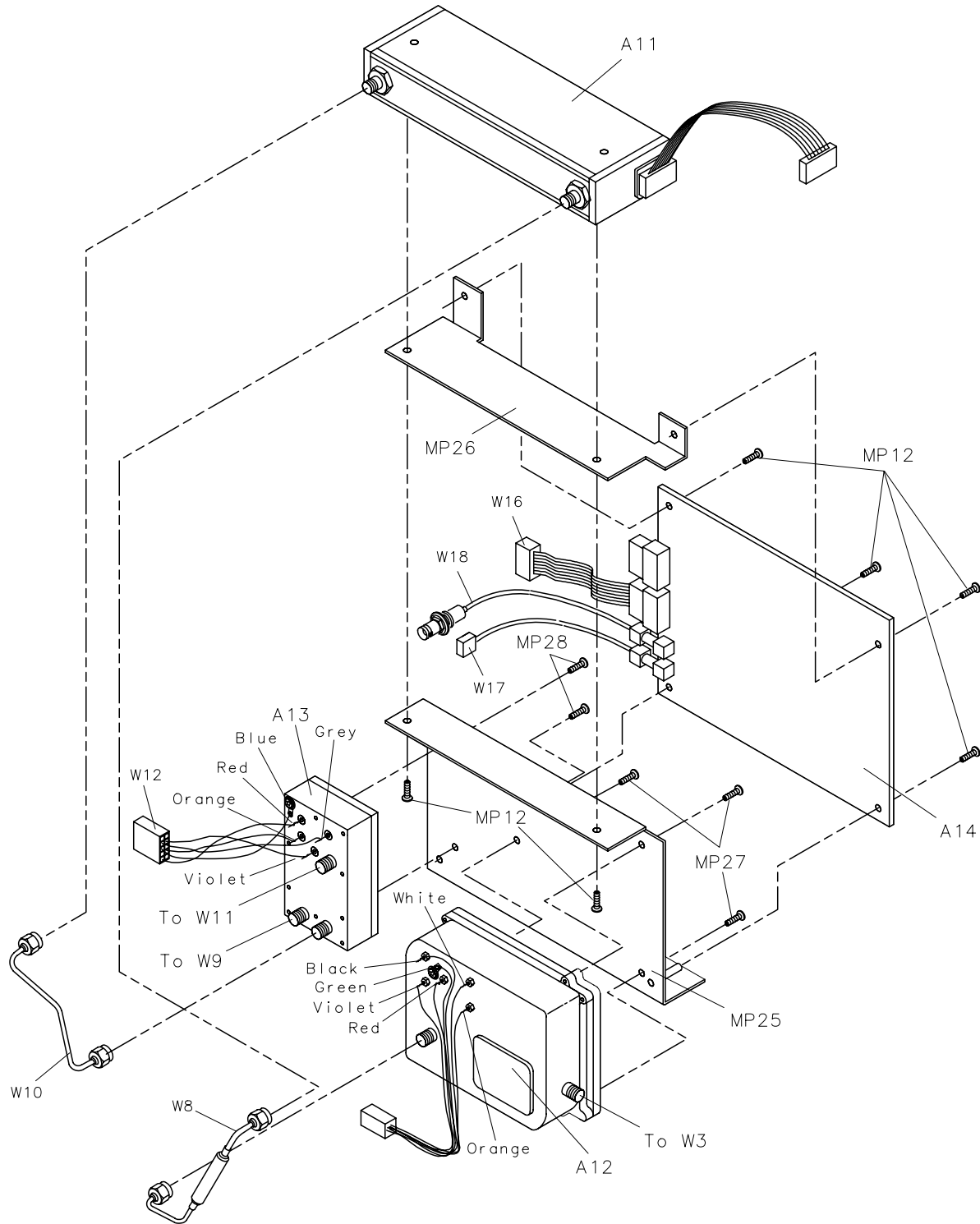

on64a2d

Table 6-2. 8648B/C/D Replaceable Parts

Item	Part Number	Qty.	Description
A1		1	FRONT FRAME ASSY (NOT AVAILABLE FOR REPLACEMENT)
A1A1	0960-0856	1	RPG
A1A2	0960-0856	1	RPG
A1A3	08648-60178	1	FLEX CIRCUIT
A1A4	2090-0362	1	DISPLAY VFD 2x40 (Serial prefixes \geq 3836A/3836U)
	2090-0312	1	DISPLAY LCD 2x40 (Serial prefixes $<$ 3836A/3836U)
A1J1	1250-1811	1	RF OUTPUT TYPE-N CONNECTOR
A1MP1	08648-60189	1	FRONT FRAME KIT (Serial prefixes \geq 3836A/3836U)
	08648-60022	1	FRONT FRAME KIT (Serial prefixes $<$ 3836A/3836U)
A1MP2	08647-40008	1	KEYPAD
A1MP3	08647-00004	1	DISPLAY MOUNT
A1MP4	08647-00019	1	COVER DISPLAY
A1MP5	01650-47401	1	KNOB-CURSOR
A1MP6	01650-47401	1	KNOB-CURSOR
	08648-80059	1	NAME PLATE 8648B
	08648-80060	1	NAME PLATE 8648C
	08648-80043	1	NAME PLATE 8648D
A2	0950-2293	1	POWER SUPPLY
A3	08648-60614	1	MOTHERBOARD ASSY (Serial prefixes \geq 3836A/3836U)
	08648-60314	1	MOTHERBOARD ASSY (Serial prefixes $<$ 3836A/3836U)
	08648-69614	1	EXCHANGE MOTHERBOARD KIT (Serial prefixes \geq 3836A/3836U)
	08648-69314	1	EXCHANGE MOTHERBOARD KIT (Serial prefixes $<$ 3836A/3836U)
A3A1	08648-60146	1	MEMORY BOARD (FIRMWARE KIT)
A3BT1	1420-0338	1	BATTERY 3.0V 1.2AH
A3J1	1252-2161	1	CONNECTOR RECT24F
A3J2	1252-1487	1	CONNECTOR RECT 9 F RA
A3J18	1250-1842	1	10 MHZ INPUT BNC
A3J19	1250-1842	1	10 MHZ OUTPUT BNC
A3R6	2100-4507	1	CONTRAST POTENTIOMETER (Serial prefixes $<$ 3836A/3836U)
A3S1	3101-2264	1	TIMEBASE ADJ SWITCH
A4	08647-61045	1	STANDARD REFERENCE ASSEMBLY

Table 6-2. 8648B/C/D Replaceable Parts

Item	Part Number	Qty.	Description
	08647-69045	1	STANDARD EXCHANGE REFERENCE ASSEMBLY
	08920-40009	2	CAM LEVERS (P/O A4)
	08920-40016	2	LEVER LOCKS (P/O A4)
A4	08648-60042	1	OPTION 1E5 HIGH STABILITY REFERENCE ASSEMBLY
	08648-69042	1	EXCHANGE OPTION 1E5 HIGH STABILITY REFERENCE ASSEMBLY
	08920-40009	2	CAM LEVERS (P/O A4)
	08920-40016	2	LEVER LOCKS (P/O A4)
A5	08648-60115	1	SIG GEN SYNTH ASSEMBLY
	08648-69115	1	EXCHANGE SIG GEN SYNTH ASSEMBLY
	08920-40009	2	CAM LEVERS (P/O A5)
	08920-40016	2	LEVER LOCKS (P/O A5)
A5	08648-60124	1	SIG GEN SYNTH ASSEMBLY (OPTION 1EP)
	08648-69124	1	EXCHANGE SIG GEN SYNTH ASSEMBLY (OPTION 1EP)
	08920-40009	2	CAM LEVERS (P/O A5)
	08920-40016	2	LEVER LOCKS (P/O A5)
A6	08648-60200	1	OUTPUT ASSEMBLY
	08648-69200	1	EXCHANGE OUTPUT ASSEMBLY KIT
	08920-40009	2	CAM LEVERS (P/O A6)
	08920-40016	2	LEVER LOCKS (P/O A6)
A9	9135-0270	1	FILTERED LINE MODULE
	0361-1265	2	RIVETS (HOLDS A9 TO MP1)
A10	08648-60199	1	FREQUENCY EXTENSION MODULE
	08648-69199	1	EXCHANGE FREQUENCY EXTENSION MODULE
A11	33322-60011	1	MICROWAVE ATTENUATOR
A12	08648-60025	1	REVERSE POWER PROTECTION ASSEMBLY (RPP)
	08648-60143	1	REVERSE POWER PROTECTION REPLACEMENT KIT (Serial prefixes < 3619A and< 3443U)
A13	08648-60010	1	PULSE MODULATOR ASSEMBLY (OPTION 1E6)
A14	08648-60126	1	AUDIO GENERATOR BOARD ASSEMBLY (OPTION 1E2)
	08648-69126	1	EXCHANGE AUDIO GENERATOR BOARD ASSEMBLY (OPTION 1E2)
	08648-60374	1	AUDIO GENERATOR UPGRADE KIT (OPTION 1E2)

Table 6-2. 8648B/C/D Replaceable Parts

Item	Part Number	Qty.	Description
B1	3160-0866	1	FAN TBAX
F1	2110-0780	1	FUSE 3 A 250 V (NOT SHOWN)
MP1	08647-61025	1	ASSEMBLY CHASSIS KIT (For serial prefixes < 3836A/3836U, also order 08647-61030)
MP2	08647-00026	1	COVER CARDBOX
MP3	08647-00030	1	COVER-MOTHERBOARD
MP4	08647-00031	1	COVER-RF
MP5	08647-00020	1	MOUNT-POWER SUPPLY
MP6	08648-00012	1	CLAMP (MEMORY BOARD BRACKET)
MP7			(NOT ASSIGNED)
MP8	08647-00028	1	COVER-INSTRUMENT
MP9	5041-3621	1	LINE SWITCH KEY CAP
MP10	5041-8801	4	FOOT FULL MOD
MP11	0515-2086	4	SCREW M4 x .07 7MM-LG 90- DEG-FLH-HD
MP12	0515-0372	18	SCREW MACH. M3 x 0.5 8MM-LG
MP13	0515-0380	35	SCREW MACH.M4 x 0.7 10MM-LG
MP14	0515-2243	4	SCREW MACH. M4.0 12SEMPAN TX
MP15	08647-40003	2	REAR FOOT HANDLE
MP16	0515-0669	1	SCREW MACH. M4 x 0.7 30MM-LG
MP17	0515-0669	1	SCREW MACH. M4 x 0.7 30 MM-LG
MP18	0361-1341	4	RIVET NYL 3.9DIA (HOLDS B1 TO MP1)
MP19	2950-0054	2	NUT HEX 1/2 - 28
MP24	2190-0584	3	WASHER LOCK M3
MP25	08648-00025	1	Z-BRACKET
MP26	08648-00026	1	TOP BRACKET OPTION 1E2
MP27	0515-0664	1	SCREW MACH M3 x 12MM-LG
MP28	0515-0367	2	SCREW MACH M2.5 x 8MM-LG
S1	3101-2216	1	LINE SWITCH
	0515-1940	2	SCREW MACH 2.5 6PCHPANTX (P/O S1)
W1	08647-61007	1	MODULATION CABLE
W2	08647-61011	1	DISPLAY CABLE
W3	08648-20127	1	RF OUTPUT CABLE (RPP TO RF OUTPUT)

Table 6-2. 8648B/C/D Replaceable Parts

Item	Part Number	Qty.	Description
W4	08647-61005	1	POWER SUPPLY CABLE
W5			(NOT ASSIGNED)
W6	08647-61004	1	ASSEMBLY INCLUDES (LINE SWITCH, S1, AND WIRE HARNESS AND LINE MODULE, A9)
W7	08648-20128	1	CABLE (FREQUENCY EXTENSION TO ATTENUATOR)
W8	08648-20015	1	CABLE (ATTENUATOR TO RPP)
W9	08648-20129	1	SEMI-RIGID CABLE (FREQUENCY EXTENSION TO PULSE MODULE) (OPTION 1E6)
W10	08648-20130	1	SEMI-RIGID CABLE (PULSE MODULE TO ATTENUATOR) (OPTION 1E6)
W11	08648-60005	1	PULSE MODULE COAX ASSEMBLY (OPTION 1E6)
W12	08648-60006	1	PULSE MODULE CABLE ASSEMBLY (OPTION 1E6)
W16	8120-6873	1	RIBBON CABLE ASSEMBLY, AUDIO BIAS (A14J1 TO A3J18) (OPTION 1E2)
W17	08648-80057	1	CABLE ASSEMBLY, AUDIO GEN (A14J3 TO A3J21) (OPTION 1E2)
W18	08648-80056	1	CABLE ASSEMBLY, FRONT PANEL AUDIO CABLE (A14J2 TO MOD INPUT/OUTPUT) (OPTION 1E2)
MISCELLANEOUS			
	5961-4720	1	TRANSIT CASE
	08648-10012	1	SERVICE SUPPORT SOFTWARE
	08648-60175	1	KIT TEST POINT EXTENDER
	08648-60180	1	SERVICE SOFTWARE KIT

7 Adjustments

This chapter documents the adjustments for the 8648 and the service support software that is used for the automated adjustments. There are both manual and automated adjustment procedures documented in this chapter. This chapter is organized with the following order.

- manual adjustments procedures
- automated adjustment descriptions
- service support software description

Refer to Table 5-2 for information regarding which adjustments should be performed after an assembly is repaired or replaced.

Test Equipment

The required test equipment for the adjustments is listed in Table 5-1. Along with the required test equipment, this table lists the critical specifications of each, the recommended model number, and the adjustments that this equipment is used to perform.

Equipment Setup for Automated Tests

The complete test equipment setup includes the 8648 that is being tested (the DUT), a personal computer (PC) that runs the adjustment software, and the various instruments that make up the electronic test equipment. The PC must have a GPIB Interface Bus installed in one of its card slots. The DUT is connected to the PC's GPIB card via a GPIB cable. Another GPIB cable connects the PC to the electronic test equipment. The electronic test equipment must be connected together via additional GPIB cables.

NOTE Although the test setup illustrations do not show the PC or the GPIB cable connections, these connections are required to perform the automated tests and adjustments.

Test Point Extender

One additional adapter is required to perform the adjustments. Several adjustments use J31 as a test point on the motherboard of the DUT. The adapter is used to extend the J31 test point so that it can be accessed for the adjustments. The J31 Test Point Extender (part number 08648-60175) and service support software can be obtained, together, by ordering part number 08648-60180.

You can also build the J31 Test Point Extender by using the following instructions. J31 is a six-pin connector on the motherboard. The test point extender consists of a six-pin connector housing attached to six crimped wires that will plug into J31. The six wires should be of different colors so that you can differentiate between the wires with just a glance. A good method of differentiating between the wires is by using the resistor color code values to identify the pin number. For example, the value of orange in the resistor color code is "3"; so the orange wire is connected as pin 3 of the test point extender.

The recommended part numbers for the test point extender are shown below.

Table 7-1. J31 Test Point Extender Parts List

Description	Part Number	Quantity
Connector housing, 6-pin	1251-5981	1
Crimp connectors	1251-5216	6
Wire, 22AWG, brown (color code value - 1)	8150-0007	1 foot
Wire, 22AWG, red (color code value - 2)	8150-0022	1 foot
Wire, 22AWG, orange (color code value - 3)	8150-0017	1 foot
Wire, 22AWG, yellow (color code value - 4)	8150-0038	1 foot
Wire, 22AWG, green (color code value - 5)	8150-0011	1 foot
Wire, 22AWG, blue (color code value - 6)	8150-0014	1 foot

If you constructed your own test point extender, you can use this table to record your color code so that it can be readily identified in the future.

Enter your J31 Test Point Extender Color Code Here					
Pin 1	Pin 2	Pin 3	Pin 4	Pin 5	Pin 6

Figure 7-1. J31 Test Point Extender

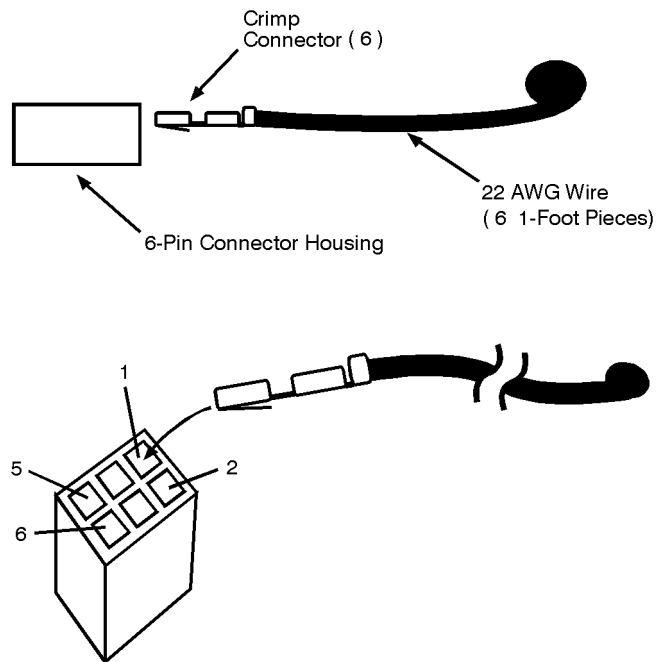

an620a2d

Manual Adjustments

This section documents the following manual adjustments:

- Internal Reference Oscillator Adjustment
- Pager Encoder Timebase Frequency Adjustment

Internal Reference Oscillator Adjustment

Use this procedure to adjust the internal timebase reference DACs. The internal reference oscillator is adjusted with two DACs, one for coarse tuning and one for fine tuning. Using the two DACs, the internal reference oscillator can be adjusted to the resolution of the frequency counter used.

NOTE This manual adjustment can be replaced by performing the automated Time Base DAC calibration instead.

Required Test Equipment

- 5316B Frequency Counter
- 5071A primary Frequency Standard

Procedure

1. Turn off power to the signal generator.
2. Set the rear panel TIMEBASE ADJUST switch to on (1). (See [Figure 7-2.](#))

Figure 7-2. Timebase Adjust Switch Location

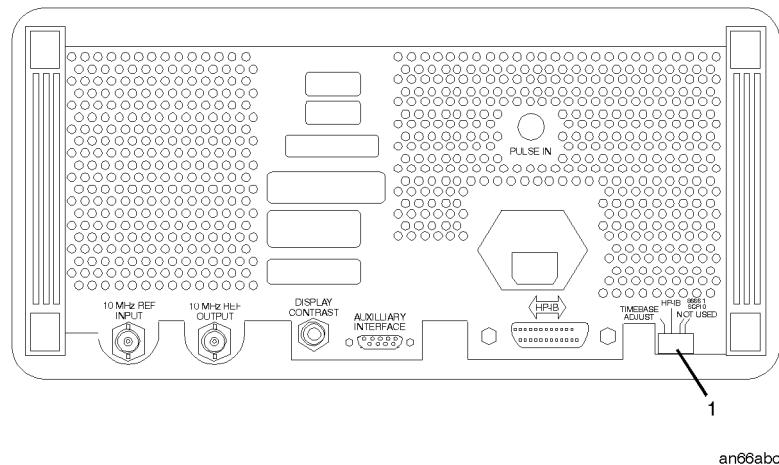

3. Turn on power to the signal generator and wait for the self-tests to run.
4. Connect the equipment as shown in [Figure 7-3.](#) (The DUT is the signal generator under test.)

Figure 7-3. Internal Reference Oscillator Adjustment Setup

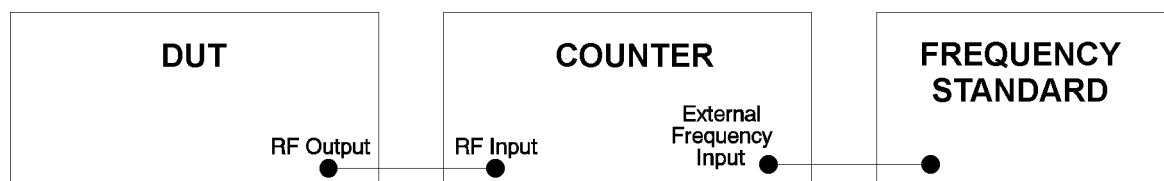

an627a2d

5. Follow the instructions on the signal generator's display and adjust the knobs until the frequency counter reads 100 MHz within 1 Hz resolution.
6. When the adjustment is complete, turn off the signal generator.
7. Set the rear-panel TIMEBASE ADJUST switch to off (0).

Pager Encoder Timebase Frequency Adjustment

Use this procedure to adjust the pager encoder timebase frequency.

Required Test Equipment

- 5334B Option 010 Universal Counter

Procedure

1. Turn off power to the signal generator.
2. Remove the instrument cover.
3. Connect the MOD INPUT/OUTPUT connector of the signal generator to the input of the universal counter as shown in [Figure 7-4](#).

Figure 7-4. Pager Encoder Timebase Frequency Adjustment Setup

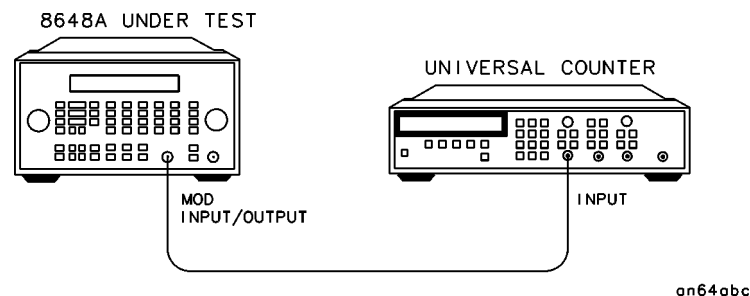

4. Turn on power to the signal generator and let it warm up for one hour.
5. Enter the pager encoder mode by pressing **FM (ENCODER)** twice. (If FM was the last active function, only press the **FM (ENCODER)** key once.)
6. Rotate the **AMPLITUDE/ENCODER** knob to set **FORMAT** to **SERVICE**.
7. Press **↓ (NEXT)** and rotate the **AMPLITUDE/ENCODER** knob to set **CALIBRATION FSK** to **3200/2**.
8. Press **INCR SET (START/STOP)** to turn the encoder output on. The universal counter should now read close to 1600 Hz.
9. Adjust the variable capacitor on the encoder timebase until the frequency on the universal counter reads 1600 Hz ± 0.0016 Hz. (The capacitor is labeled "TIMEBASE ADJUST 1EP" in [Figure 7-5](#).)

Figure 7-5. Variable Capacitor Location

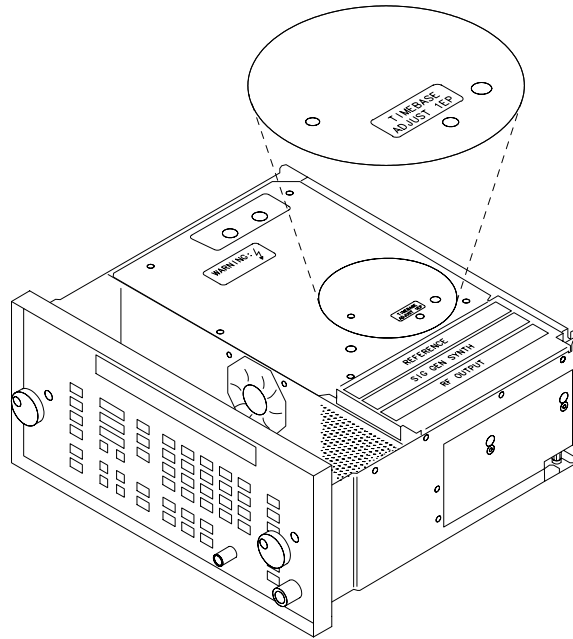

an615abc

10. Turn power off to the signal generator and replace the instrument cover.

Automated Adjustments

This section documents the following automated adjustments:

1. AM Level and Distortion (Not used for serial prefixes \geq 3847A/3847U)
2. Detector Offset (Not used for serial prefixes \geq 3847A/3847U)
3. Output Level
4. AM Level: FE (Not used for serial prefixes \geq 3847A/3847U)
5. Predistortion and Detector Offset (Not used on some versions of hardware)
6. Prelevel
7. Output Level: FE
8. AM Modulator
9. Time Base DAC
10. Motherboard Audio Path
11. DCFM
12. Audio Generator
13. HF Power Level Accuracy
14. LF Output Level
15. LF Power Level Accuracy
16. FSK Deviation
17. Filter Path

Note: Before performing these automated adjustments:

- Ensure that the Device Under Test (DUT) and all test equipment have been turned on at least 45 minutes. Shorter warm-up times may result in improper adjustment.
- Ensure that all GPIB connections are securely made between the test equipment, the DUT, and the PC.

AM Level and Distortion (8648A Only)

Not used for serial prefixes \geq 3847A/3847U.

Description

This adjustment adjusts AM level accuracy and distortion on the output module. It also zeros the general loss and attenuation arrays. It uses the DVM to measure the dc voltages that are being adjusted on the output module.

Required Test Equipment

- Function Generator
- DVM
- J31 Test Point Extender (refer to the “Test Point Extender” section at the front of this chapter)

Procedure

Figure 7-6. AM Level and Distortion Test Setup 1

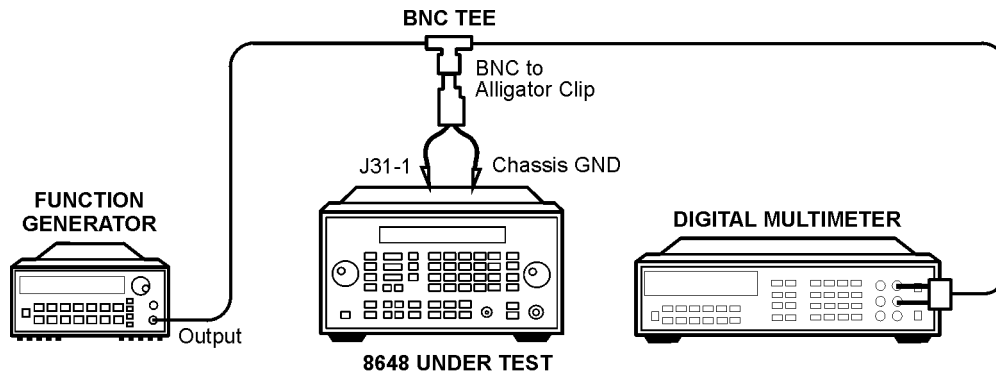

an617a2d

Figure 7-7. AM Level and Distortion Test Setup 2

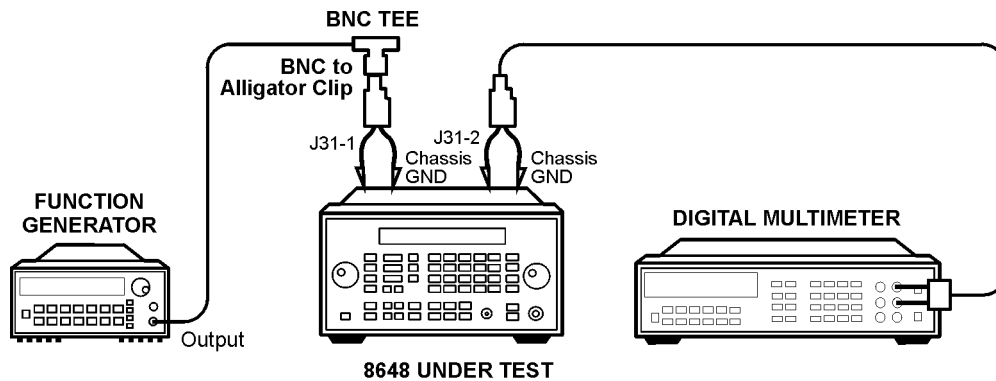

an618a2d

Figure 7-8. Location of J30, J31, and J32 on the Motherboard

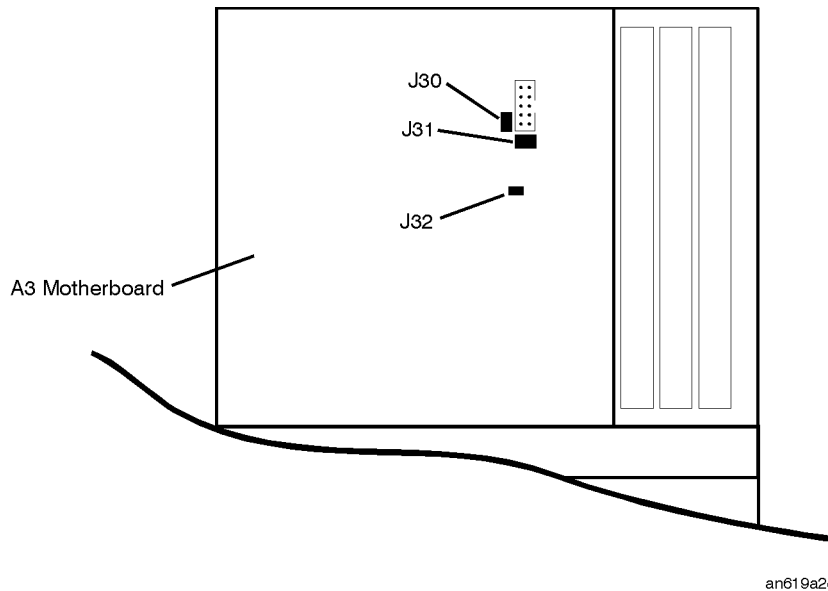

1. With the line power turned off, install the Test Point Extender on J31. (J31 pin 1 is the rear pin on the right edge of connector J31.)
2. If jumper J30 is installed on the motherboard, remove it.
3. If jumper J32 is installed on the motherboard, remove it.
4. Turn on the line power.
5. Connect the equipment as shown above.
6. Preset all of the equipment.
7. Follow the instructions as they are displayed on the PC.

AM Level (8648B/C/D Only)

(Not used for serial prefixes \geq 3847A/3847U)

Description

This adjustment adjusts AM level accuracy on the output module. It uses the DVM to measure the dc voltages that are being adjusted on the output module.

Required Test Equipment

- Function Generator
- DVM
- J31 Test Point Extender (refer to the “Test Point Extender” section at the front of this chapter)

Procedure

Figure 7-9. AM Level Test Setup 1

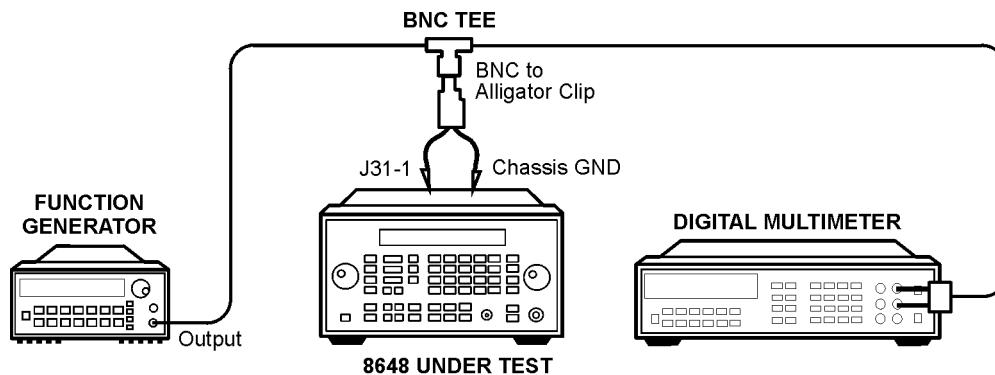

an617a2d

Figure 7-10. AM Level Test Setup 2

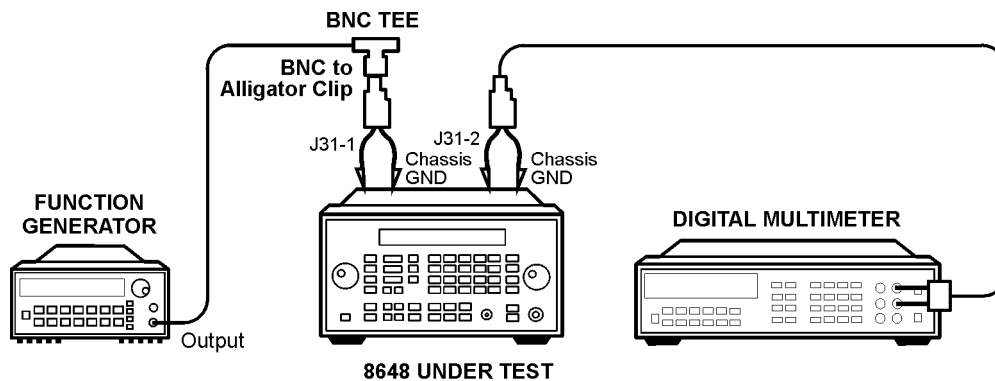

an618a2d

Figure 7-11. Location of J31 and J32 on the Motherboard

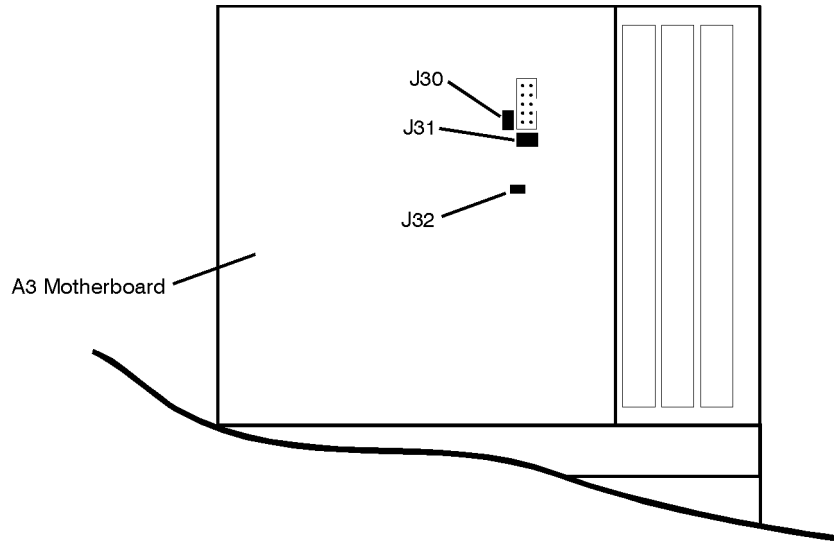

1. With the line power turned off, install the Test Point Extender on J31. J31 pin 1 is the rear pin on the right edge of connector J31.
2. If jumper J32 is installed on the motherboard, remove it.
3. Turn on the line power.
4. Connect the equipment as shown above.
5. Preset all of the equipment.
6. Follow the instructions as they are displayed on the PC.

Detector Offset (8648A Only)

(Not used for serial prefixes \geq 3847A/3847U)

Description

This adjustment sets up the output board to allow the detector offset potentiometer to be adjusted. A high level reference is set up and then the DAC is reduced by 13 dB and the detector offset potentiometer is adjusted for 13 dB.

Required Test Equipment

- Power Meter
- Power Sensor

Procedure

Figure 7-12. Detector Offset Test Setup

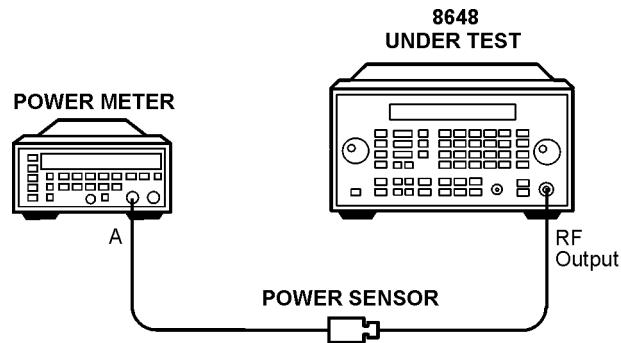

an69a2d

1. Connect the equipment as shown above.
2. Preset all of the equipment.
3. Follow the instructions as they are displayed on the PC.

Output Level (8648A Only)

Description

This adjustment creates the slope and offset calibration data for the output section.

This adjustment will not allow any calibration data to be stored unless all of the calibration data points are measured.

Required Test Equipment

- Power Meter
- Power Sensor

Procedure

Figure 7-13. Detector Offset Test Setup

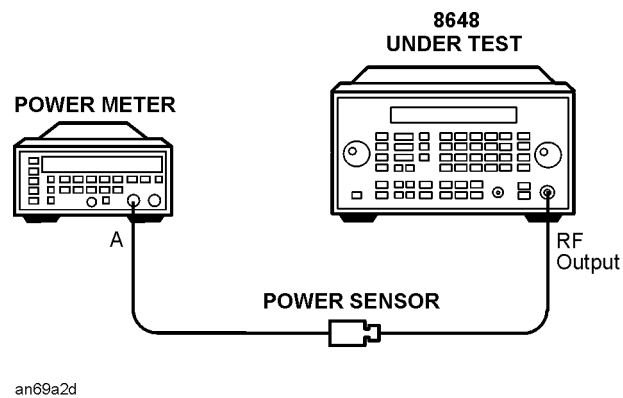

1. Connect the equipment as shown above.
2. Preset all of the equipment.
3. Follow the instructions as they are displayed on the PC.

AM Level: FE (8648B/C/D Only)

Not used for serial prefixes \geq 3847A/3847U.

Description

This adjustment performs the AM Level adjustment on the frequency extension module by connecting the function generator and the DVM to motherboard connector J31.

This adjustment performs the two adjustments to the output board that require the use of the voltmeter. It sets up the multiplexer on the output board to measure dc voltages while the potentiometers are being adjusted.

Required Test Equipment

- Function Generator
- DVM
- J31 Test Point Extender (refer to the “Test Point Extender” section at the front of this chapter)

Procedure

Figure 7-14. AM Level: FE Test Setup 1

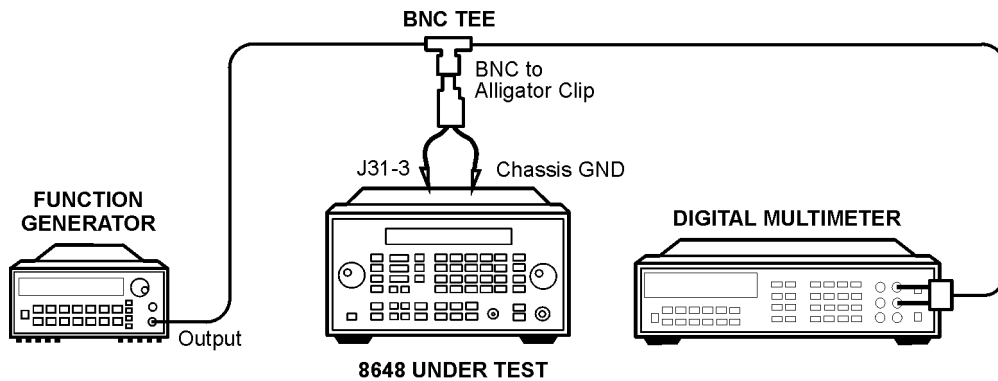

an623a2d

Figure 7-15. AM Level: FE Test Setup 2

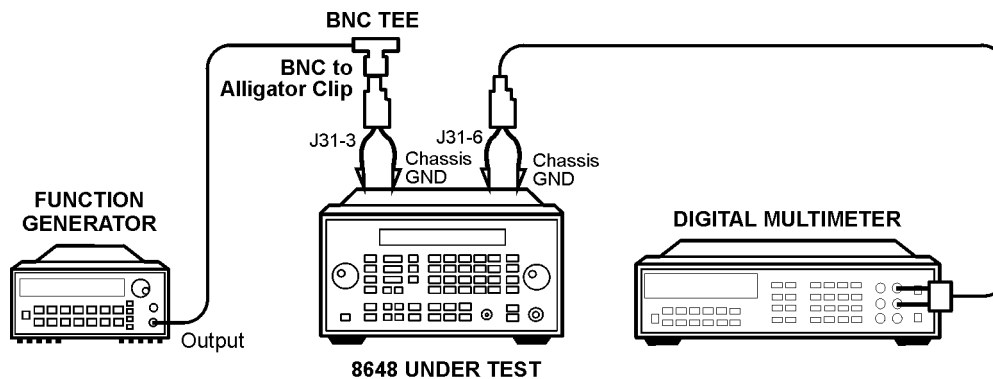

an624a2d

Figure 7-16. Location of J31 and J32 on the Motherboard

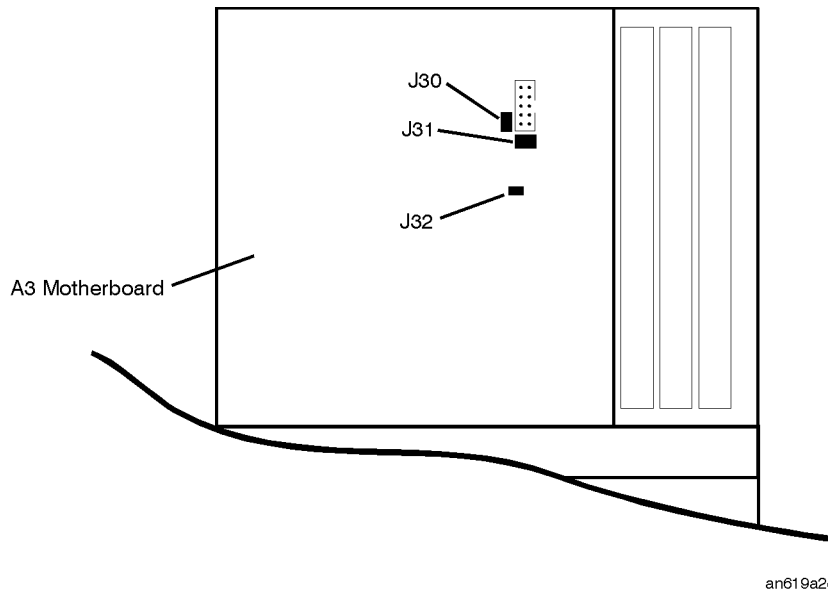

1. With the line power turned off, install the Test Point Extender on J31. (J31 pin 1 is the rear pin on the right edge of connector J31.)
2. If jumper J32 is installed on the motherboard, remove it.
3. Turn on the line power.
4. Connect the equipment as shown above.
5. Preset all of the equipment.
6. Follow the instructions as they are displayed on the PC.

Predistortion and Detector Offset (8648B/C/D Only)

(Some versions of hardware do not have the following potentiometers. Do not run this adjustment if the potentiometers are not present.)

Description

This adjustment sets up the Detector Offset potentiometer on the A10 frequency extension board and the Predistortion potentiometer on the A6 output board while measuring the power at the RF Output connector. With the DUT set to 100 MHz, the Detector Offset potentiometer is adjusted for -10 dBm reading at the RF output. Then, the Predistortion potentiometer is adjusted for -17.5 dBm at the RF output. These two adjustments are iterated between until both power levels are within 0.1 dBm of their respective power levels. The DUT is set to 1.5 MHz and the predistortion potentiometer is adjusted for -17.0 dBm.

Required Test Equipment

- Power Meter
- Power Sensor

Procedure

Figure 7-17. Predistortion and Detector Offset Test Setup

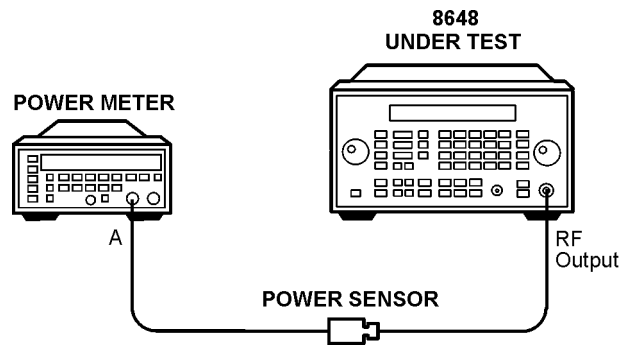

an69a2d

1. Connect the equipment as shown above.
2. Preset all of the equipment.
3. Follow the instructions as they are displayed on the PC.

Prelevel (8648B/C/D Only)

Description

This adjustment creates the slope and offset calibration data for the preleveler calibration.

The adjustment will not let you store away any calibration data unless all of the calibration data points are run.

Required Test Equipment

- Power Meter
- Power Sensor

Procedure

Figure 7-18. Prelevel Test Setup

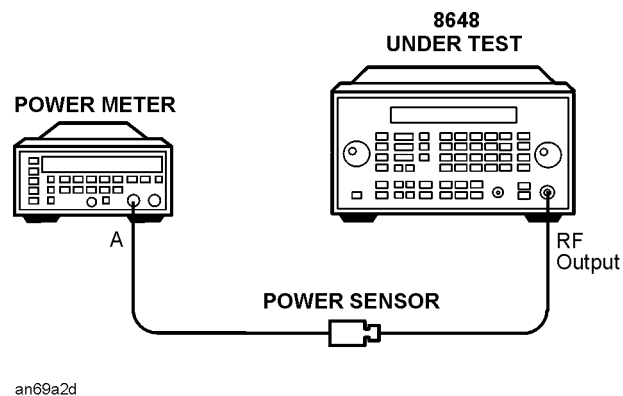

1. Connect the equipment as shown above.
2. Preset all of the equipment.
3. Follow the instructions as they are displayed on the PC.

Output level: Frequency Extension Calibration (8648B/C/D Only)

Description

This adjustment creates the slope and offset calibration data for the output calibration. The adjustment will not let you store away any calibration data unless all of the calibration data points are run.

Required Test Equipment

- Power Meter
- Power Sensor

Procedure

Figure 7-19. Frequency Extension Calibration Test Setup

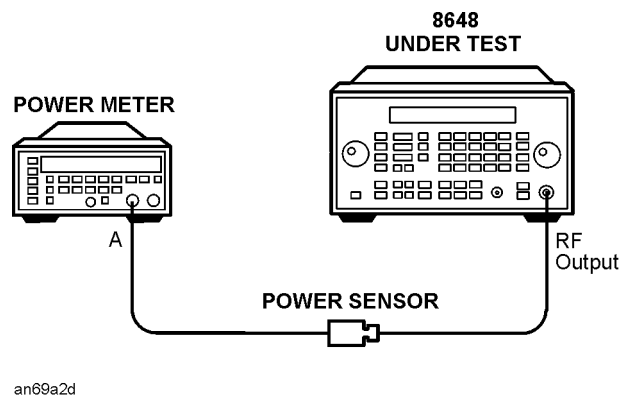

1. Connect the equipment as shown above.
2. Preset all of the equipment.
3. Follow the instructions as they are displayed on the PC.

AM Modulator (8648A Only)

Description

This is the AM Accuracy adjustment for the 8648A. This adjustment performs the two adjustments to the output board that require the use of the voltmeter. It sets up the multiplexer on the output board to measure dc voltages while the potentiometers are being adjusted.

Required Test Equipment

- Measuring Receiver
- Function Generator
- Audio Analyzer
- DVM
- J31 Test Point Extender (refer to the “Test Point Extender” section at the front of this chapter)

Procedure

Figure 7-20. AM Modulator Test Setup

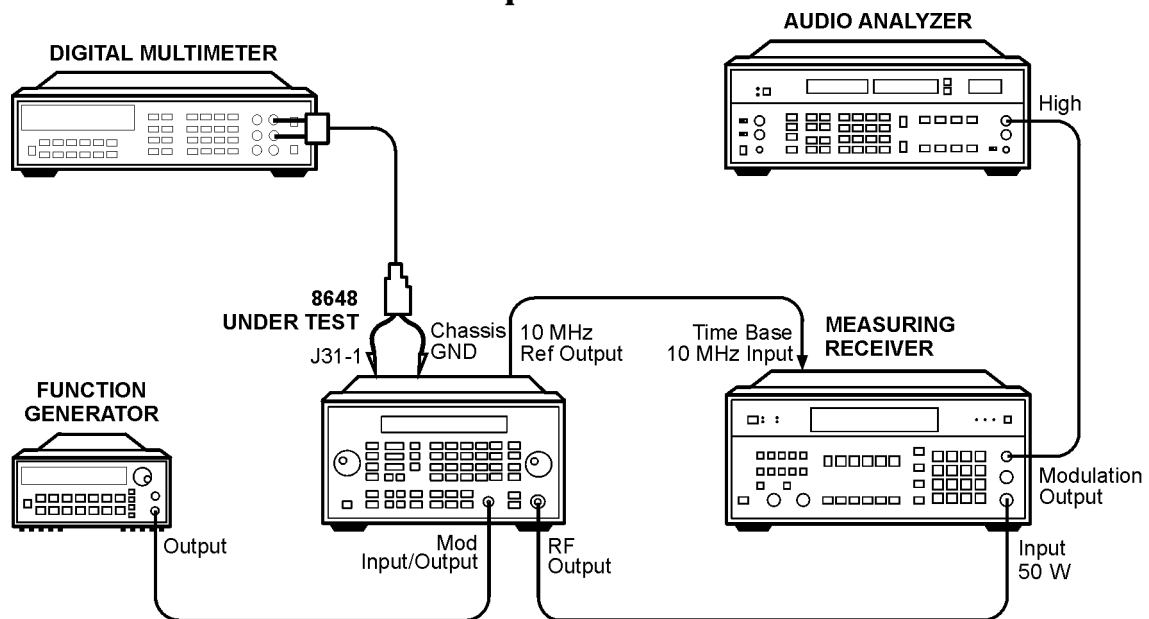

an615a2d

Figure 7-21. Location of J31 on the Motherboard

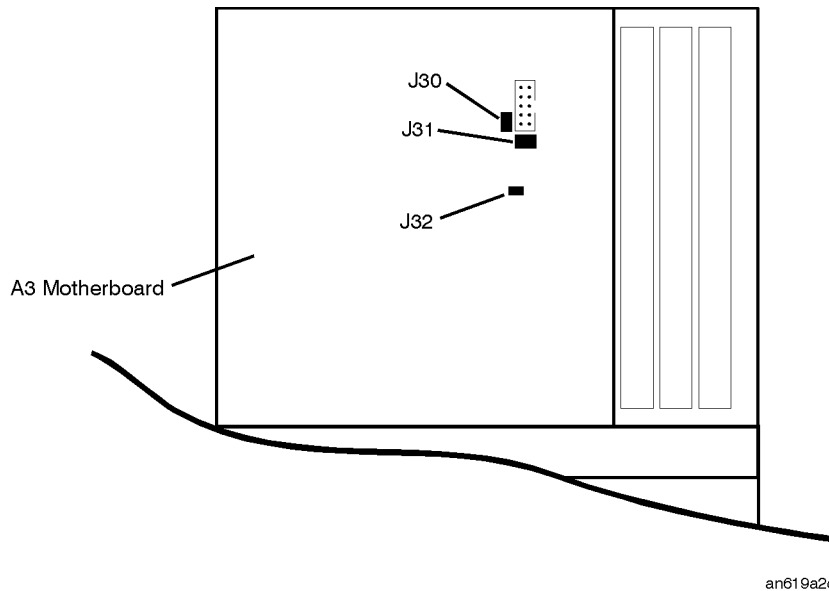

1. With the line power turned off, install the Test Point Extender on J31. (J31 pin 1 is the rear pin on the right edge of connector J31.)
2. If jumper J32 is installed on the motherboard, remove it.
3. Turn on the line power.
4. Connect the equipment as shown above.
5. Preset all of the equipment.
6. Follow the instructions as they are displayed on the PC.

Time Base DAC (All 8648A/B/C/D)

NOTE A manual adjustment is available. This automated adjustment can be replaced by performing the manual Internal Reference Oscillator Adjustment instead.

Description

This adjustment determines the proper DAC setting to achieve a frequency reading of 1 GHz \pm 1 Hz. The DAC settings are then stored away.

This program determines the proper DAC setting to achieve a frequency reading of 1 GHz \pm 1 Hz. The DAC setting is then stored away.

Required Test Equipment

- Spectrum Analyzer
- Primary Frequency Standard

Procedure

Figure 7-22. Time Base DAC Setup

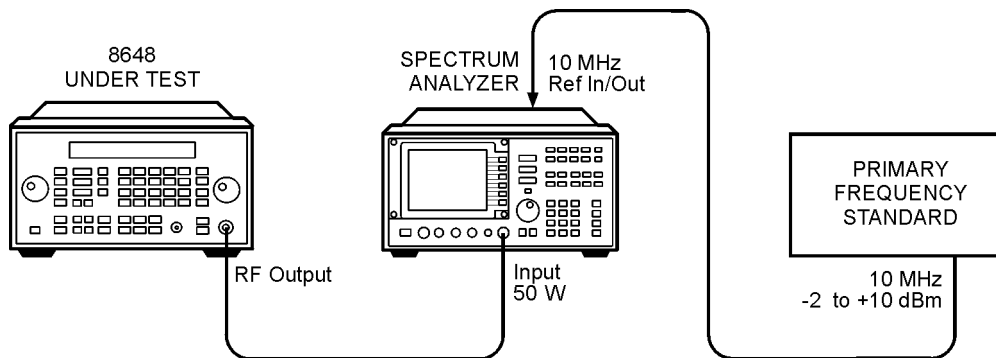

an612a2d

1. Connect the equipment as shown above.
2. Preset all of the equipment.
3. Follow the instructions as they are displayed on the PC.

Motherboard Audio Path (All 8648A/B/C/D)

This adjustment calibrates the internal and external audio paths of the motherboard by determining the full-scale (100%) DAC values required for the audio path calibration.

For internal modulation measurements, the DAC is set to a percentage, DAC Offset Percentage, of its value. The percentage is 70% for the 8648A and 90% for the 8648B/C/D. At each DAC value, the corresponding output depth/deviation is measured with the measuring receiver and the slope of the DAC is calculated using the following:

$$\text{Slope} = \frac{(\text{Measured Depth})/(\text{Deviation})}{\left(\frac{\text{DAC Offset Percentage}}{100}\right)} \times 4095$$

The slope determines the actual value of the DAC required to set the modulation level at the exact DAC Offset Percentage. The DAC is fine-tuned by measuring the output depth/deviation and adjusting the DAC until the resulting depth/deviation is within a specified tolerance. The final value of the DAC for internal modulation measurements is calculated as follows:

$$\text{DAC Value}_{\text{int}} = \frac{\text{DAC Value at DAC Offset Percentage}}{\left(\frac{\text{DAC Offset Percentage}}{100}\right)}$$

The difference between internal and external modulation involves compensating for the inaccuracies of the external function generator. First, the voltage level of the function generator is set to 1.083 volts (not 1V) to compensate for the mismatch between its 600 ohm output and the 50 ohm input of the DUT. Then, the actual voltage is measured and the target deviation set at DAC Offset percentage of the measured voltage. The level DAC is adjusted for DAC Offset Percentage deviation and then the 100% level DAC value for external modulation measurements is calculated as shown:

$$\text{DAC Value}_{\text{ext}} = \frac{\text{DAC Value at DAC Offset Percentage}}{\text{Actual 3325B Voltage} \times \left(\frac{\text{DAC Offset Percentage}}{100}\right)}$$

Required Test Equipment

- Function Generator
- DVM
- Measuring Receiver

Procedure

Figure 7-23. Motherboard Audio Path Test Setup

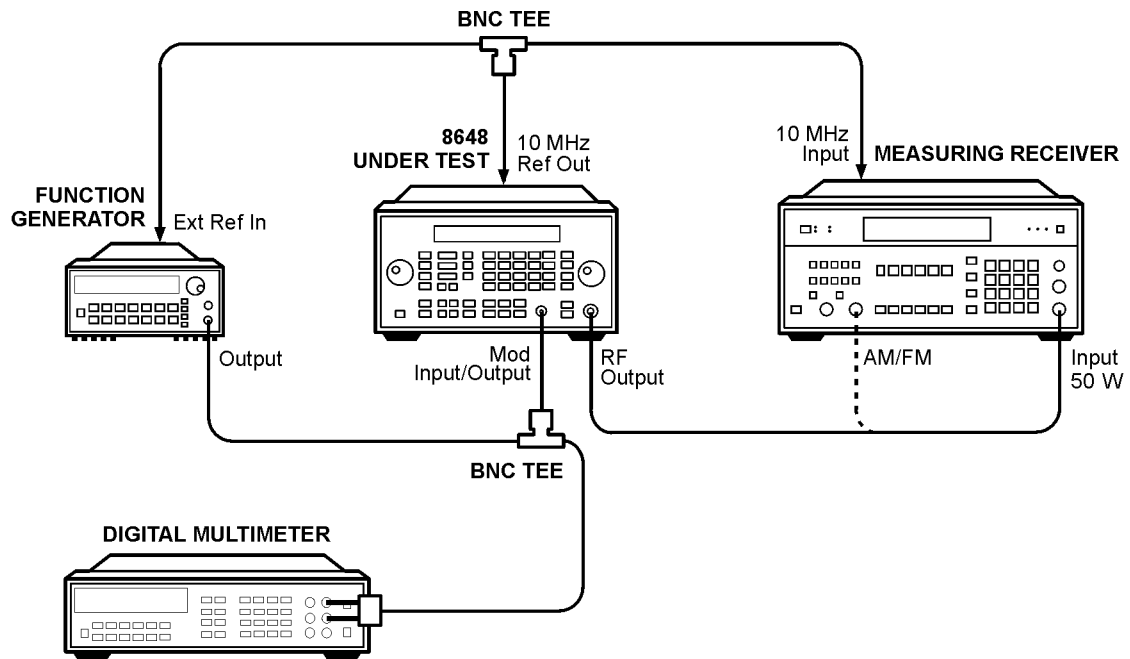

an616a2d

1. Connect the equipment as shown above.
2. Preset all of the equipment.
3. Follow the instructions as they are displayed on the PC.

DCFM (All 8648A/B/C/D)

Description

This adjustment is used to calibrate the DC FM. Make sure that nothing is connected to the MOD INPUT/OUTPUT connector on the DUT.

Required Test Equipment

- None

Procedure

Figure 7-24. DCFM Test Setup

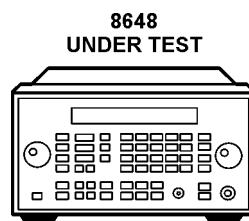

an610a2d

1. Connect the equipment as shown above.
2. Preset all of the equipment.
3. Follow the instructions as they are displayed on the PC.

Audio Generator (Options 1E2 and 1EP Only)

Description

This program generates the offset and gain calibration values for the sinewave source on the A14 modulation generator board.

Required Test Equipment

- DVM

Procedure

Figure 7-25. DCFM Test Setup

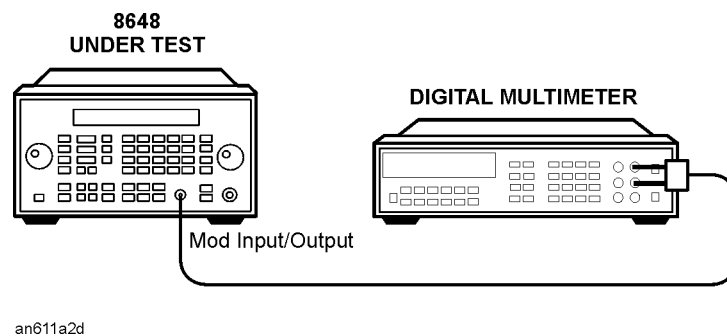

1. Connect the equipment as shown above.
2. Preset all of the equipment.
3. Follow the instructions as they are displayed on the PC.

HF Power Level Accuracy (All 8648A/B/C/D)

Description

This is the power level accuracy adjustment for the power range of 0 dBm to -130 dBm. The first step in this adjustment is to test the noise floor level to ensure at least 20 dB separation between the lowest measured power level and the spectrum analyzer noise floor. If the noise floor does not allow for 20 dB of separation at -30 dBm, then it is checked at -20 dBm. If there is not 20 dB of separation at -120 dBm, the -130 dBm correction factors will be set to the -120 dBm values.

Required Test Equipment

- Power meter
- Power Sensor
- Spectrum Analyzer
- Low Frequency Amplifier
- High Frequency Amplifier
- 6 dB Attenuator

Procedure

Figure 7-26. HF Power Level Accuracy Test Setup for Power Levels > -10 dBm

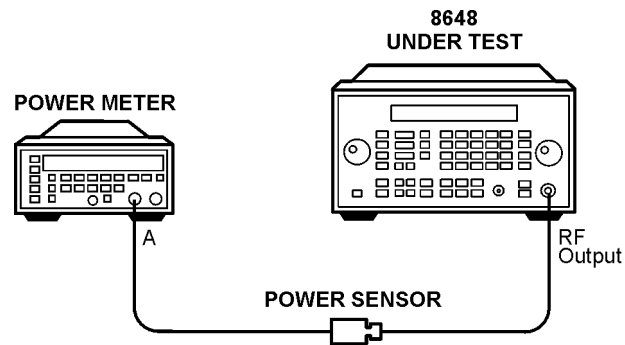

an65a2d

Figure 7-27. HF Power Level Accuracy Test Setup for Power Levels of -10 to -70 dBm

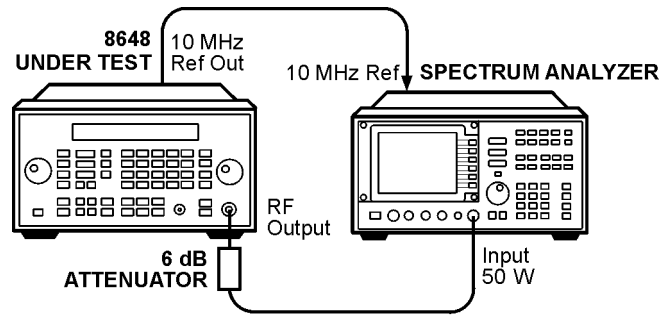

an66a2d

Figure 7-28. HF Power Level Accuracy Test Setup for Power Levels of < -70 dBm and ≤ 1300 MHz

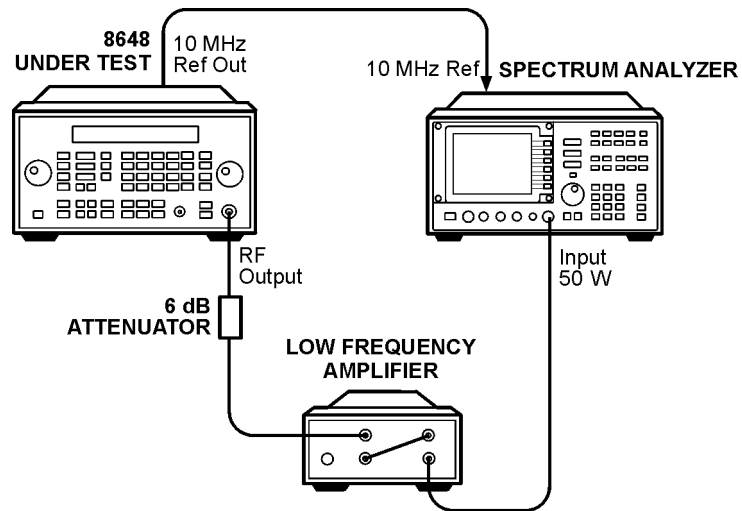

an67a2d

Figure 7-29. HF Power Level Accuracy Test Setup for Power Levels of < -70 dBm and > 1300 MHz

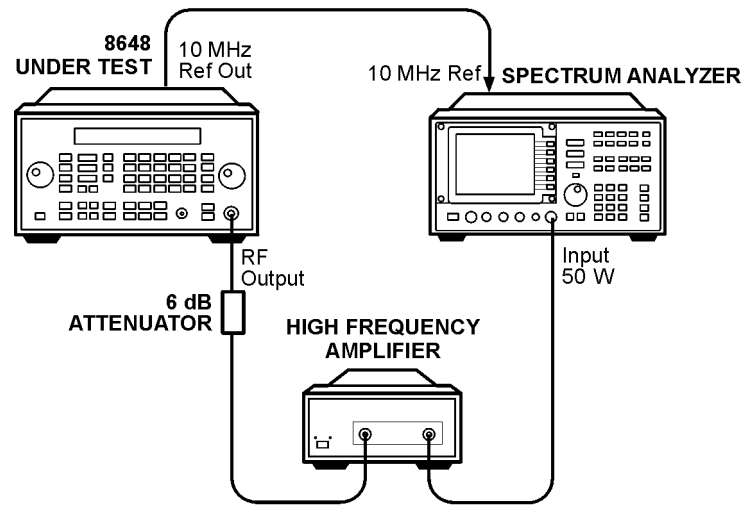

an68a2d

1. Connect the equipment as shown above.
2. Preset all of the equipment.
3. Follow the instructions as they are displayed on the PC.

LF Output Level (Most 8648B/C/D)

8648B/C Frequency Range

Early versions of the 8648B and 8648C have a frequency range that begins at 100 kHz rather than 9 kHz. If the DUT has a frequency range that begins at 100 kHz, do not run this adjustment.

Description

This adjustment creates and stores the slope and offset calibration data for the output module from 9 kHz to 100 kHz. This adjustment will not allow any calibration data to be stored unless all of the calibration data points are measured.

Required Test Equipment

- DVM
- 50 Ω Feedthrough

Procedure

Figure 7-30. LF Output Level Test Setup

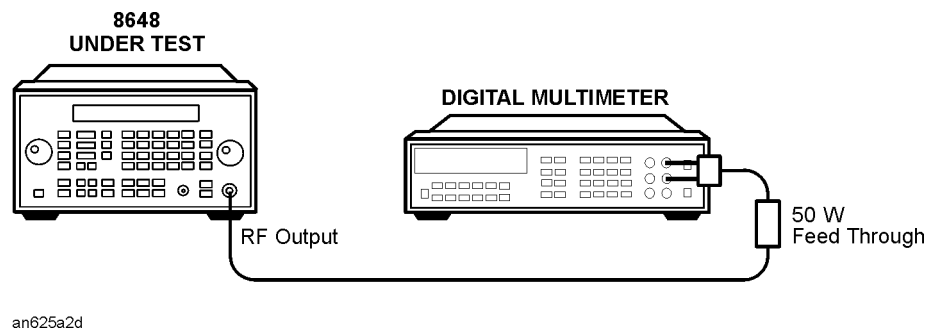

1. Connect the equipment as shown above.
2. Preset all of the equipment.
3. Follow the instructions as they are displayed on the PC.

LF Power Level Accuracy (Most 8648B/C/D)

8648B/C Frequency Range

Early versions of the 8648B and 8648C have a frequency range that begins at 100 kHz rather than 9 kHz. If the DUT has a frequency range that begins at 100 kHz, do not run this adjustment.

Description

This adjustment covers the frequency range of 9 to 100 kHz and the dynamic range of 0 to -100 dBm. Initially, the spectrum analyzer is checked to verify that its noise floor and any residuals are at least 20 dB below the lowest signal measured. If a residual is detected, the frequency is shifted plus or minus 25 Hz. If the noise floor is too high, the adjustment is exited.

Signal levels between 0 and -40 dBm are measured directly with a digital voltmeter (DVM). Lower signal levels are measured using the spectrum analyzer. All spectrum analyzer measurements are relative to the -40 DVM measurement.

Required Test Equipment

- DVM
- Spectrum Analyzer
- 6 dB Attenuator
- 50Ω Feedthrough

Procedure

Figure 7-31. LF Power Level Accuracy Test Setup for Power Levels of ≥ -40 dBm

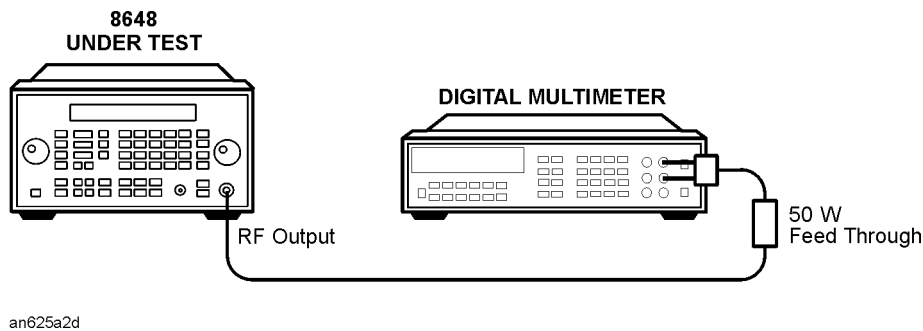
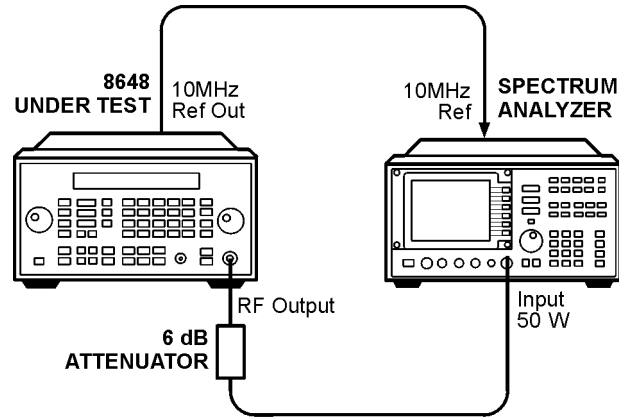

Figure 7-32. LF Power Level Accuracy Test Setup for Power Levels of < -40 dBm



an614a2d

1. Connect the equipment as shown above.
2. Preset all of the equipment.
3. Follow the instructions as they are displayed on the PC.

FSK Deviation (Option 1EP Only)

Description

This adjustment modifies the FM Multiplier and out-of-band Kv arrays used by the signal generator synthesizer module. The purpose is to provide a more accurate FM sensitivity calibration while operating with FSK modulation.

Required Test Equipment

- Vector Signal Analyzer

Procedure

Figure 7-33. FSK Deviation Test Setup

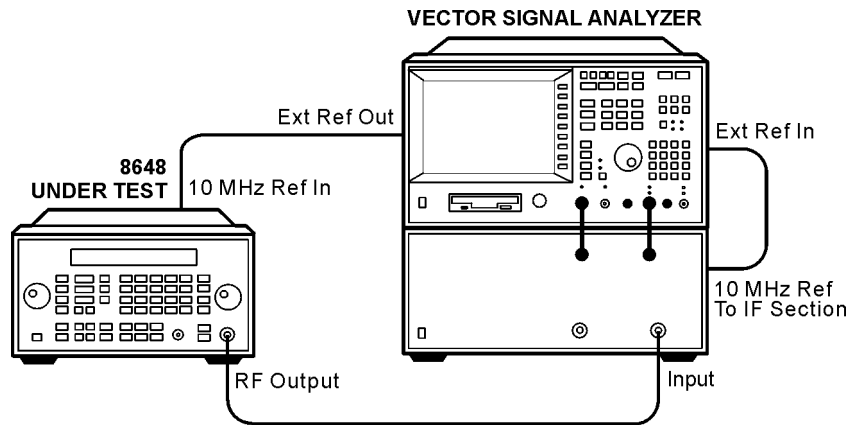

an64a2d

1. Connect the equipment as shown above.
2. Preset all of the equipment.
3. Follow the instructions as they are displayed on the PC.

Filter Path (Option 1EP Only)

Description

This adjustment creates a calibration array that optimizes deviation accuracy and nulls the carrier offset with two-level FSK modulation. Various carrier frequencies, modulation rates and encoder paths are checked.

Required Test Equipment

- Vector Signal Analyzer

Procedure

Figure 7-34. Filter Path Test Setup

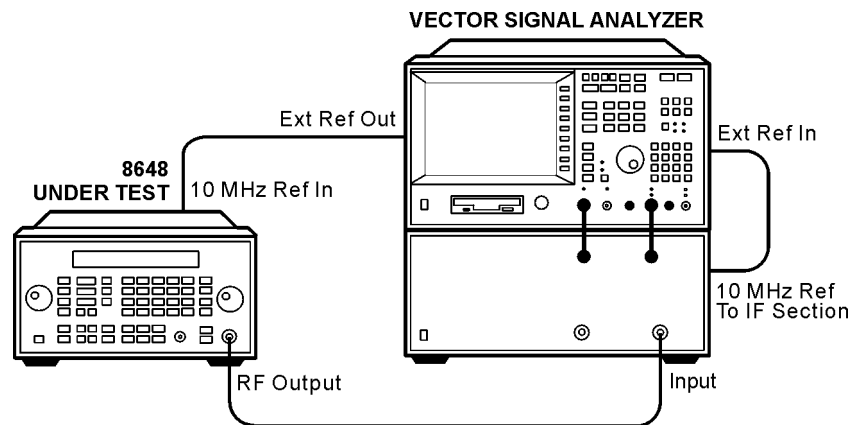

an64a2d

1. Connect the equipment as shown above.
2. Preset all of the equipment.
3. Follow the instructions as they are displayed on the PC.

Agilent Service Support Software

The service support software contains the program and supporting files necessary to run the automated performance tests and adjustments for your signal generator. This section lists the equipment required to run the software, and gives instructions for installing and using the software. Refer to the previous section for a description of each automated adjustment and refer to Chapter 8 for a description of each automated performance test.

The part number for the service support software is listed in Table 6-1 and Table 6-2.

Required Test Equipment

The following equipment is required to run the software:

- Personal Computer (PC) with the following specifications:
 - 386/33 MHz CPU or better
 - At least 8 Mbytes of RAM
 - Hard drive with at least 350 Mbytes free
 - 16-color VGA monitor or better
 - 3.5-inch disk drive
- MS Windows version 3.x or mS windows 95, 98, or NT
- 2 Button mouse (optional)
- Printer, MS Windows-supported (for test results documentation)
- 82341C GPIB Interface Card
- 16-bit HP SICL libraries (installed and configured)

CAUTION Do not install this software program on your computer if the ESG Series Support Software, Version A.02.02 or earlier, is installed on it.

Installing the Software

NOTE No other MS Windows programs may be running during installation. Close all MS Windows programs prior to starting the installation.

1. Insert "Disk 1" into the disk drive.
2. To display the Run dialog box;

For MS Windows 95, 98, NT: Select the Start button, then select Run. . .

For MS Windows version 3.x; open the Program Manager, then select Run. . . from the File drop-down menu.

3. From the Run dialog box, type a:setup and select the OK button.

The Setup window is displayed as it loads files for the installation. Once these files are loaded, the welcome screen is displayed.



4. Select Next to continue with the setup. The important Information screen is displayed. This screen contains information that is vital to installing and using the software. In addition, any new information may also be shown on this screen.

Stop now and read the information displayed.



5. Select Next and the Choose Destination Location screen is displayed. The default location for installing the software is C:/HP_SVC/HP8648. You are strongly urged to use this as the software's destination folder.



6. Select Next and the Select Program Folder screen is displayed. This installation procedure will install the service software icons into a program folder. You can enter a new folder name in the Program Folders text box or select a folder from the Existing

Folder list. We suggest “Agilent Service Software” as a good folder name.

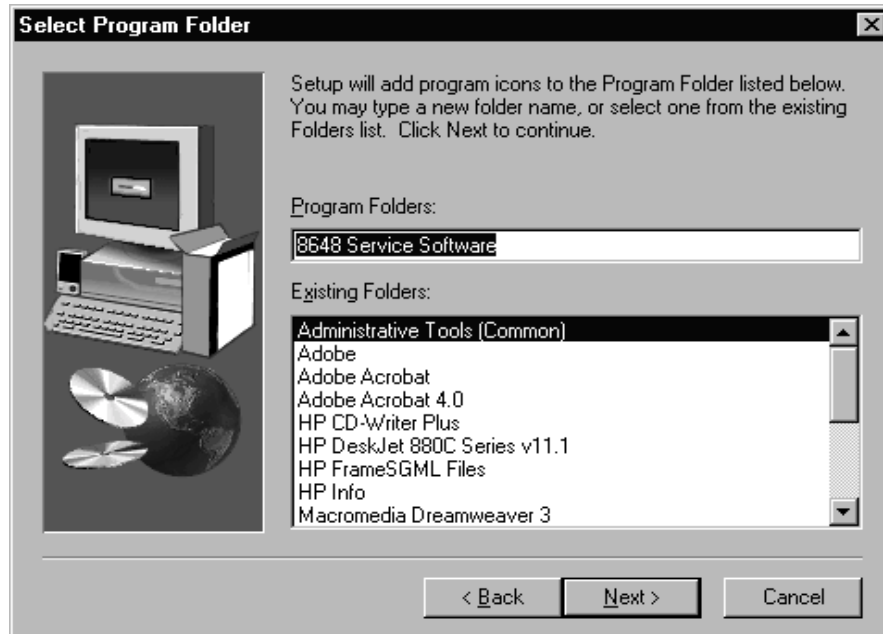

NOTE This documentation refers to the folder name as “8648 Service Software” in the future, so if you use another name for the folder, be aware that you will have to note the difference.

7. Select Next and the “Start Copying Files” window is displayed. This window shows the destination directory and the folder name settings. To change these settings, select the Back button until the appropriate window is displayed.

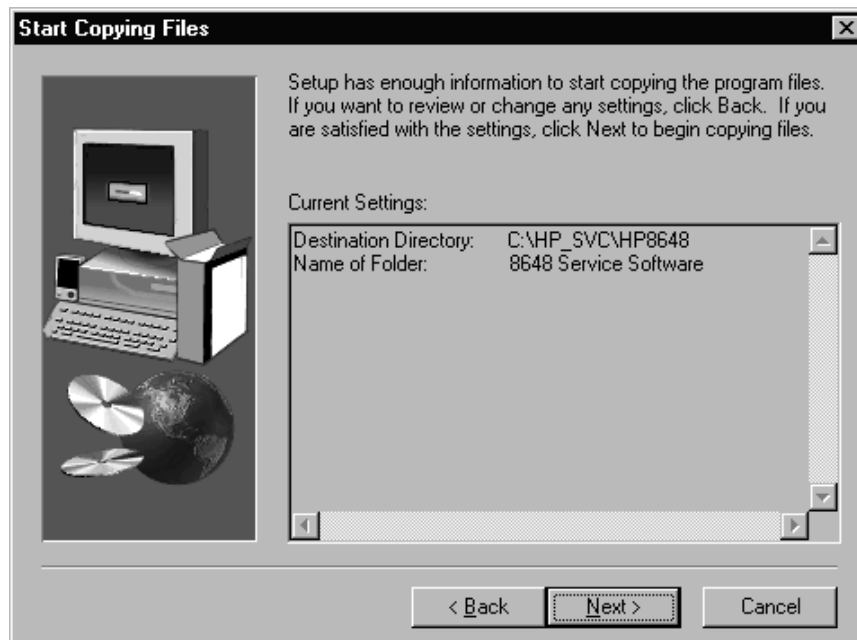

NOTE This is the last point that you can cancel the installation. if you select Next, the installation proceeds until the software is completely installed.

8. Select Next to proceed. A status gauge is displayed to show the progress of the installation.

When another of the installation disks is required, you will be notified to insert the next in the series of disks. Select the OK button when you have the required disk in place.

9. The Setup Complete screen is displayed when the installation is complete. You may choose to view the README file as well as the INFO file at this time. (You already read the INFO file when you started the installation.) Make your selection and select the Finish button.

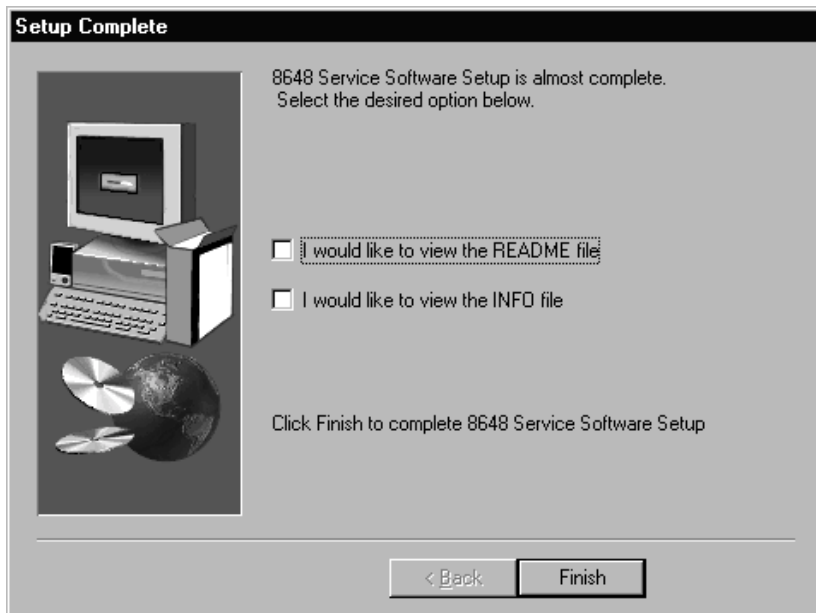

10. The MS Windows program *must* be restarted before you can use the software. Choose either to restart now, or later.

Uninstalling the Software

- MS Windows 95, 98, NT:
 1. Display the Control Panel program group by selecting Start, Settings, Control Panel.
 2. Select the Add/Remove Programs icon.
 3. From the Install/Uninstall tab in the Add Remove Programs Properties dialog box;
 - a. Select 8648 Service Software, then select the Add/Remove button.
 - b. Click yes to confirm deletion.
 4. The program is removed but the path has not been removed. Click the details button and note the path. Click OK.
 5. Display the MS Windows Explorer dialog box by selecting Start, Programs, Windows Explorer.
 6. Select the path that you previously noted, then select Delete from the Files drop-down menu to delete the path.
- MS Windows version 3.x
 1. From Program Manager, click on the program group. (Agilent Service Support was the software's default program group name.)
 2. From the File drop-down menu, select Delete.
 3. From File Manager, select the subdirectory where the program is stored. (The program's default subdirectory was hp_svc.)
 4. From the File drop-down menu, select Delete.

Service Support Software Administration

The following section shows you how to administer and run the service support software. The software's administrative functions allow for the addition or removal of all necessary test equipment, software drivers, and test procedures. This would include additional software drivers (as they are released) to extend the range of tests and equipment supported by the test set, or maintenance releases of the current drivers.

Software Configuration

Follow the instructions below to configure the software to run in either User mode or Administration mode.

Start the software:

- For MS Windows version 3.x;
 1. Open the Program Manager window.
 2. Open the Agilent Service Support program group.
 3. Select the Agilent Service Support icon.
- For MS Windows 95, 98, NT:
 1. Select Start.
 2. Select Agilent Service Software for PC's.
 3. Select Agilent Service Software.

The service support software has two configurations: User and Administration.

- **User:** Logging on in User configuration only allows access to the instrument's performance test and adjustments. Refer to the section title, 'Starting the Software'.
- **Administration:** Logging on in Administration configuration supports all administrative functions including the addition of new equipment and the installation of test procedures and device drivers.
 1. In the User Name field, type: Admin
(Case is important.)
 2. In the Password field, type: Falcon
 3. Click OK.

Adding Test Equipment

Before any performance tests can be run, your specific test equipment must be entered into the software database containing the serial numbers, calibration dates, GPIB address, and traceability information for each individual component. Only equipment which has been entered into system will be available for the test equipment selection process during the test setup. To add test equipment, follow these instructions:

1. In the DUT Selection dialog box, highlight the instrument model that you will be testing.
2. Enter the serial number of an instrument and the instrument's GPIB address.

3. Click OK.
4. Cancel the Select Test Equipment and Tests window.
5. In the File drop-down menu, select Test Equipment.

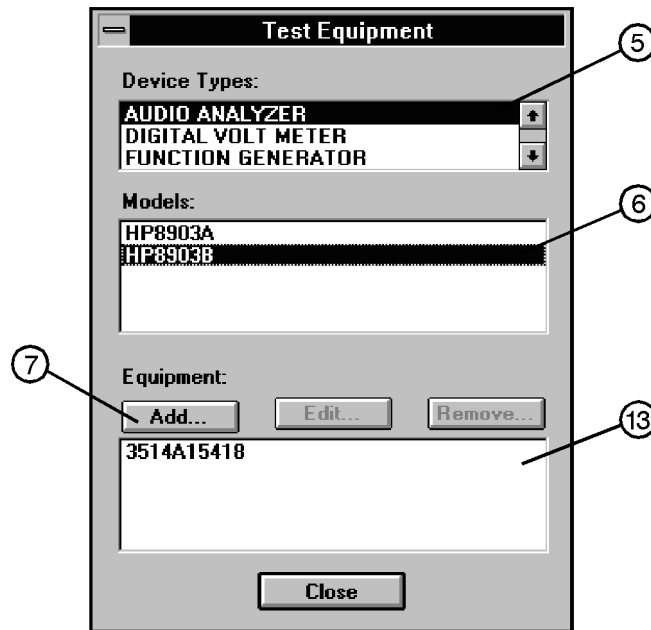

wk797a

6. In the Test Equipment dialog box, select the Device Type (5) for the new equipment you are adding.
7. Select the model of the device (6).
8. Click Add (7).

9. The New Test Equipment window is displayed:

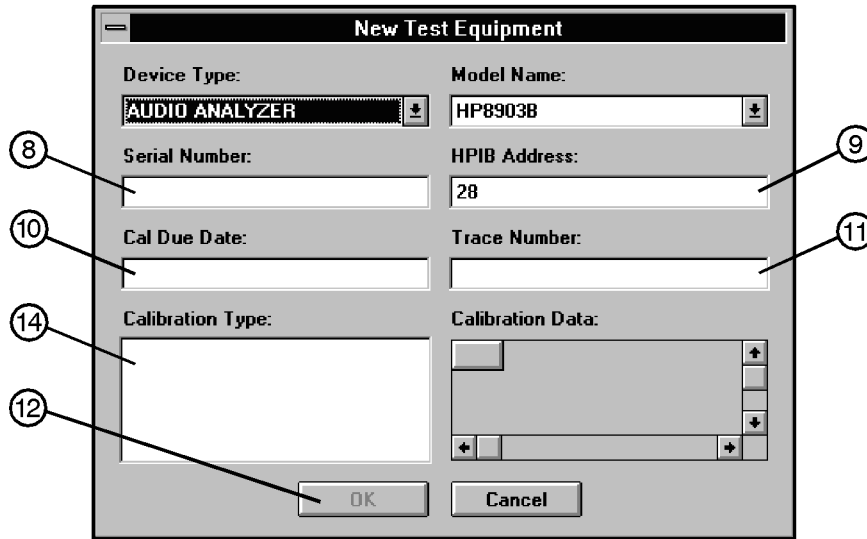

wk798a

Enter the following parameters and then click OK:

Serial Number of the new equipment (8).

GPIB Address of the new equipment (9). This address must be in the range of 0 through 31 and it should not conflict with any other instrument address already present in the test setup. Note: The power sensor must be assigned GPIB address -1 (negative 1).

Cal Due Date the projected calibration due date of the new equipment (10).

Trace Number the calibration tracking number (11). This is the last required item.

Calibration Type (optional) is used only when special calibration data is associated with the device being added, and only as a function setup by the factory for equipment requiring specific calibration data (14). The only devices currently requiring this feature are power sensors.

The following table is an example of the calibration information that is required to ensure accuracy to measurements using the power sensor. This window is accessed for data entry by selecting the words CAL DATA from the Calibration Type field in the Edit or New Test Equipment window.

Example Calibration Data	
Frequency (MHz)	Calibration Factor (%)
0.100	97.6
03000	98.9
1.0	99.1
3.0	99.4

NOTE The serial number of the test equipment added will be displayed in the Equipment field of the Test Equipment dialog box (13).

Removing Test Equipment

Removal of test equipment is accomplished using the Test Equipment dialog box.

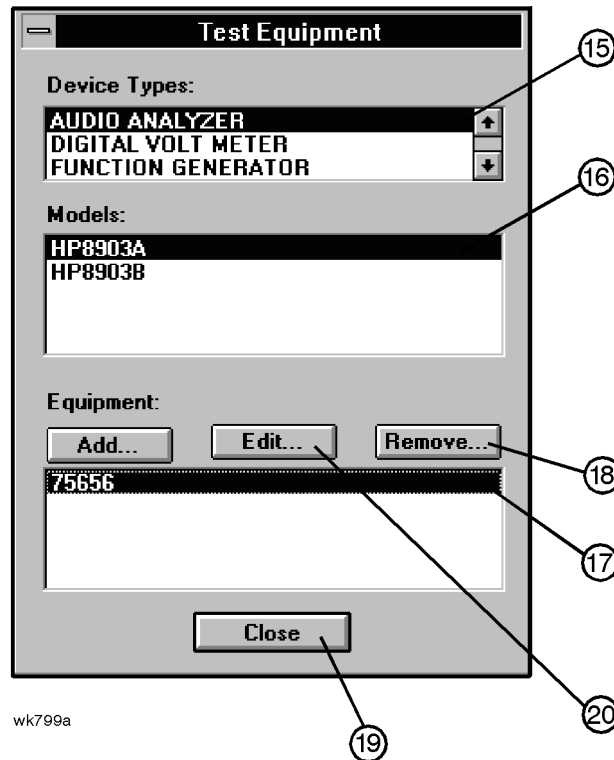

wk799a

1. Select the Device Type of the test equipment to be removed (15).
2. Select the serial number of the test equipment to be removed from the Equipment field (17)
3. Click Remove (18).
4. Click Close (19).

Editing Test Equipment

Editing test equipment parameters is accomplished using the Test Equipment dialog box.

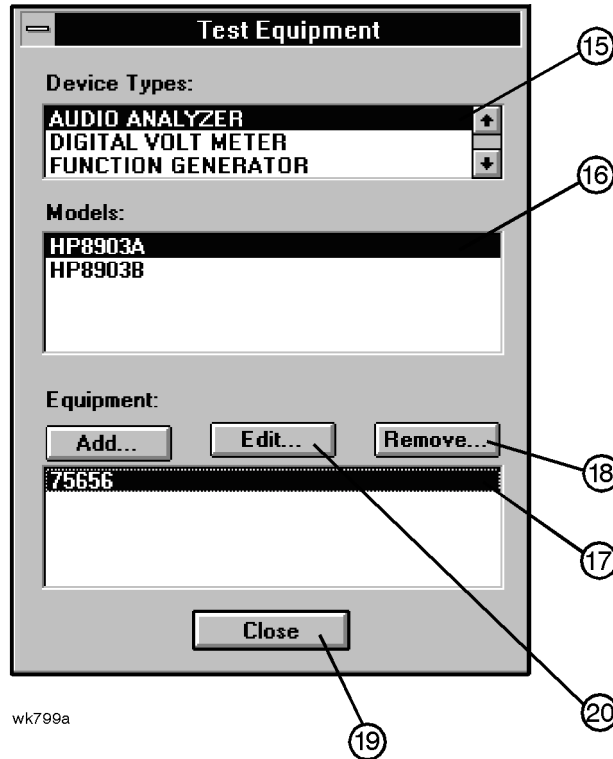

1. Select the Device Type of the test equipment to be edited (15).
2. Select the model of the test equipment to be edited from the Models field (16).
3. Select the serial number of the test equipment to be edited (17).
4. Click Edit (20). Change the field parameters as necessary.
5. Click OK (12).
6. Click Close (19).

Adding Device Drivers

CAUTION The following three procedures: Adding/Removing Device (Test Equipment) Drivers, Adding/Removing Test Drivers, and Adding/Removing Datapacks are included for informational purposes. These procedures should only be

used when instructions are provided describing which drivers or datapacks need replacement or removal.

Follow these instructions to add test equipment drivers to the program:

1. Log into the software and enter your password. The Select Test Equipment and Tests window is displayed. Click cancel.
2. In the File drop-down menu, select Test Equipment Drivers. This selection allows for the addition or removal of software drivers for the test equipment being used to verify the performance of the DUT.

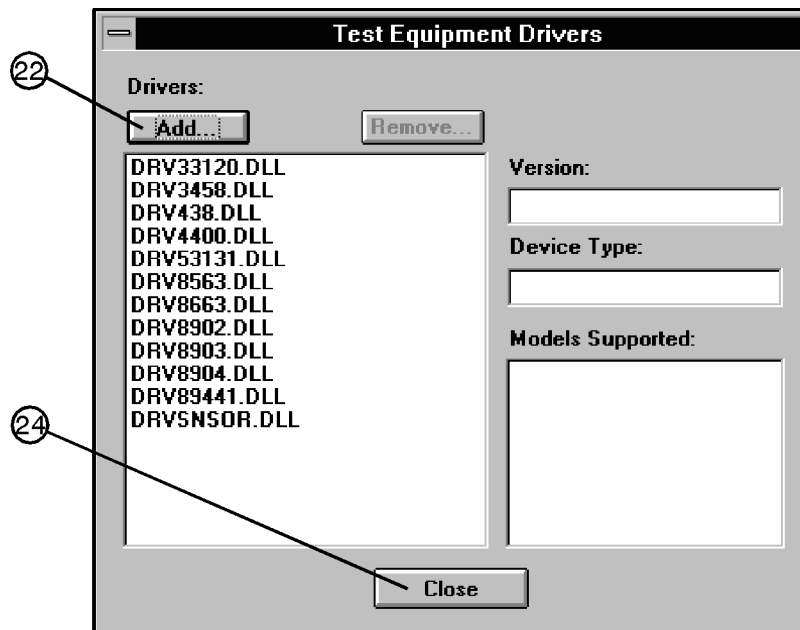

wk765a

3. To add a device driver to the existing list of test equipment drivers, click Add (22).
4. Using the standard file search procedure, select the driver that you are adding and click OK. The selected driver should now be displayed in the Test Equipment Drivers dialog box.
5. Click Close (24).

Removing Device Drivers

Removing device drivers is accomplished using the Test Equipment Drivers dialog box.

1. Log in.
2. Cancel the Select Test Equipment and Tests window.

3. Select Test Equipment Drivers from the File drop-down menu.

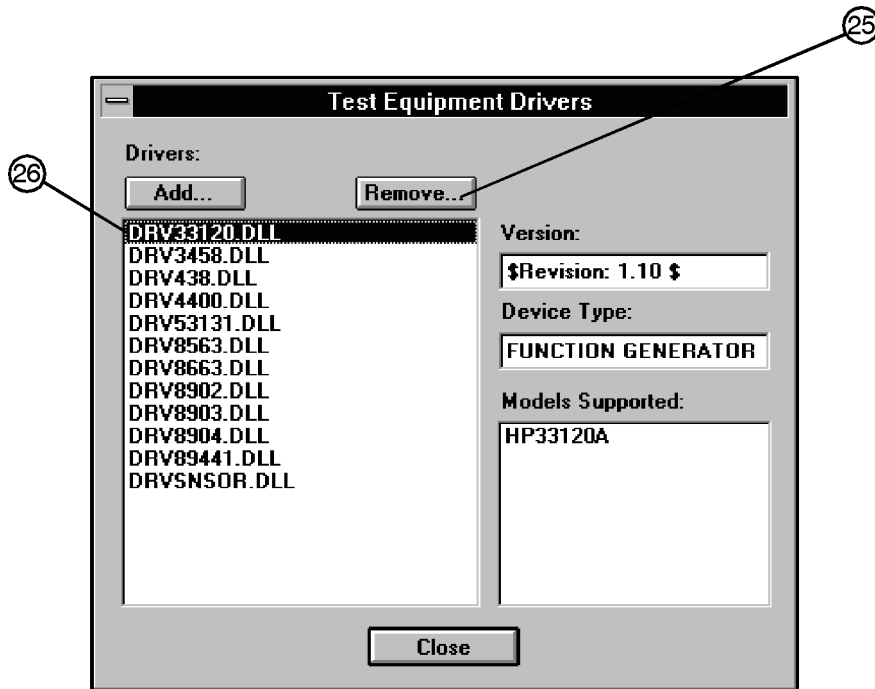

wk766a

4. Select the driver (.dll) file to be removed (26).
5. Ensure that the information displayed in the Version, Device Type, and Models Supported fields reflects the current information for the selected driver.
6. Click Remove (25).
7. Click Close.

Adding Test Drivers

The Test Drivers window allows for the addition of software drivers for the test procedures being used to verify the performance of the DUT. Follow these instructions to add a test driver.

1. Log in.
2. Cancel the Select Test Equipment and Tests window.

3. Select Test Drivers from the File drop-down menu.

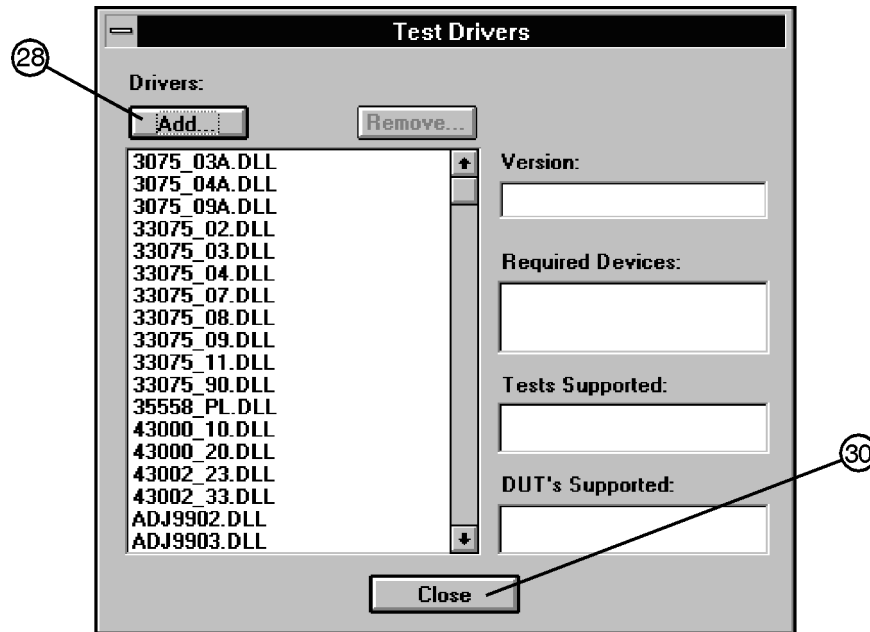

wk774a

4. Click Add (28).

5. Using the standard file search procedure, select the test driver that you are adding and click OK. The selected driver should now be displayed in the Test Drivers dialog box.

6. Click Close (30).

Removing Test Drivers

Removing test drivers is accomplished using the Test Drivers dialog box.

1. Log in.

2. Cancel the Select Test Equipment and Tests window.

3. Select Test Drivers from the File drop-down menu.

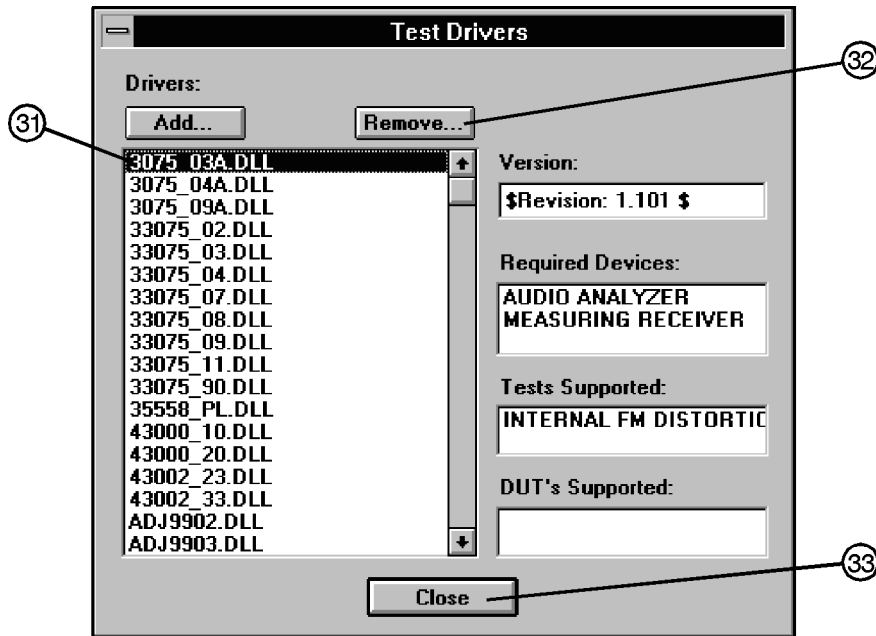

wk775a

4. Select the driver (.dll) file to be removed (31).
5. Ensure that the information displayed in the Version, Device Type, and Models Supported fields reflects the current information for the selected driver.
6. Click Remove (32).
7. Click Close (33).

Adding Datapacks

The addition of datapacks is accomplished using the Datapacks dialog box. The Datapacks window allows for the addition of datapacks for the test procedures being used to verify the performance of the DUT. Follow these instructions to add a datapack:

1. Log in.
2. Cancel the Select Test Equipment and Tests window.

3. Select Datapacks from the File drop-down menu.

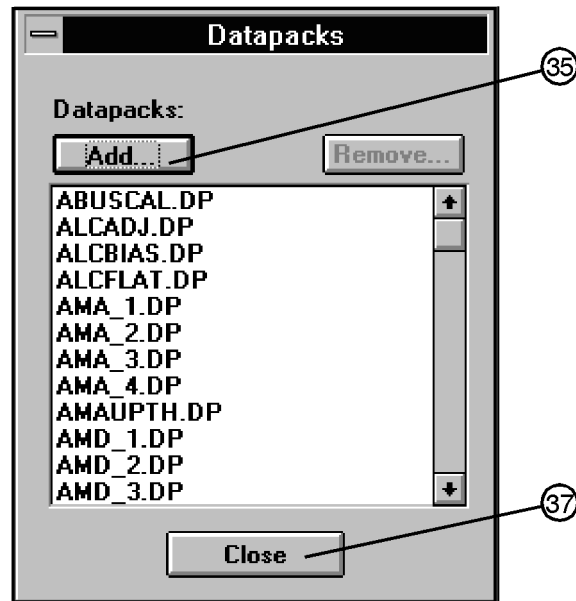

wk794a

4. Click Add (35).
5. Using the standard file search procedure, select the datapack that you are adding and click OK. The selected datapack should now be displayed in the Datapacks dialog box.
6. Click Close (37).

Removing Datapacks

Removing datapacks is accomplished using the Datapacks dialog box.

1. Log in.
2. Cancel the Select Test Equipment and Tests window.

3. Select Datapacks from the File drop-down menu.

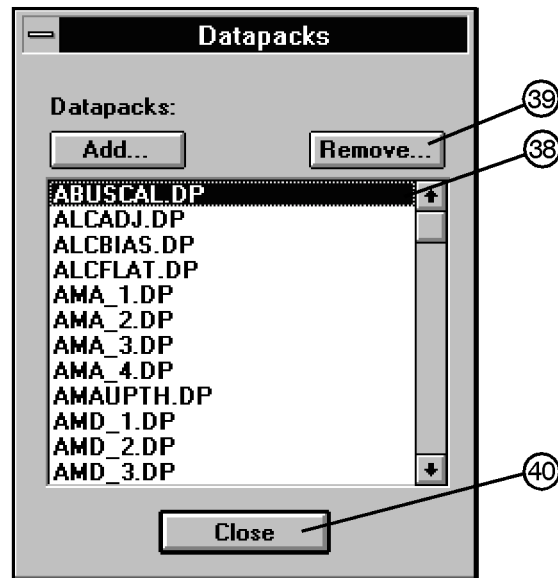

wk796a

4. Select the datapack (.dp) file to be removed (38).
5. Click Remove (39).
6. Click Close (40).

Running the Service Support Software

Starting the Software

- For MS Windows version 3.x;
 1. Open the Program Manager window.
 2. Open the Agilent Service Support program group.
 3. Select the Agilent Service Support icon.
 - For MS Windows 95, 98, NT:
 1. Select Start.
 2. Select Agilent Service Software for PC's.
 3. Select Agilent Service Software.
1. Log in using the User Information dialog box.
 - a. In the User Name field, type: `User`
(Case is important.)
 - b. In the Password field, type: `User`
 - c. Click OK.

Identifying the DUT

After logging in, the DUT Selection dialog box is displayed:

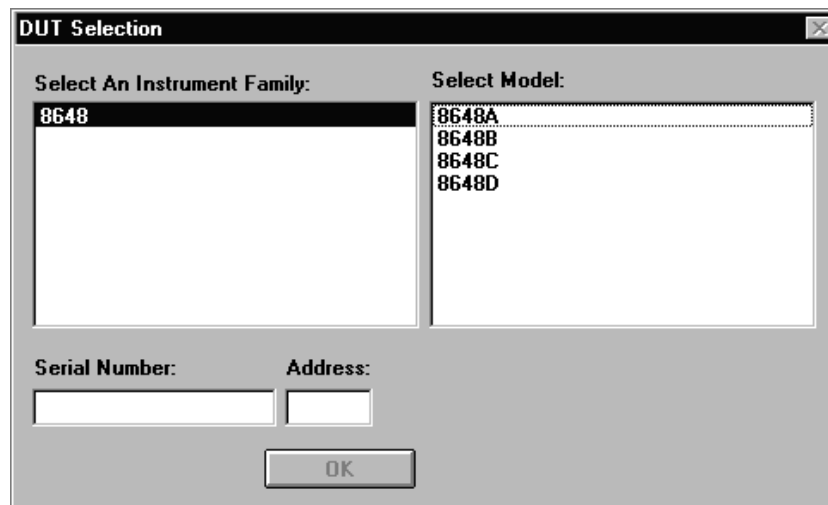

1. Ensure that 8648 is selected in the Select an instrument family list.
2. In the Select model list, select the instrument model of the DUT to be adjusted or tested.
3. In the Serial Number box, enter the complete serial number of the DUT.

4. In the Address box, enter the two-digit GPIB address of the DUT. (Press the **ADRS** key to display the DUT's GPIB address.)
5. Select the OK button.

Selecting the Performance Test or Adjustments and the Test Equipment

1. once the DUT Selection dialog box has been completed, the Select Test Equipment and Tests dialog box is displayed:

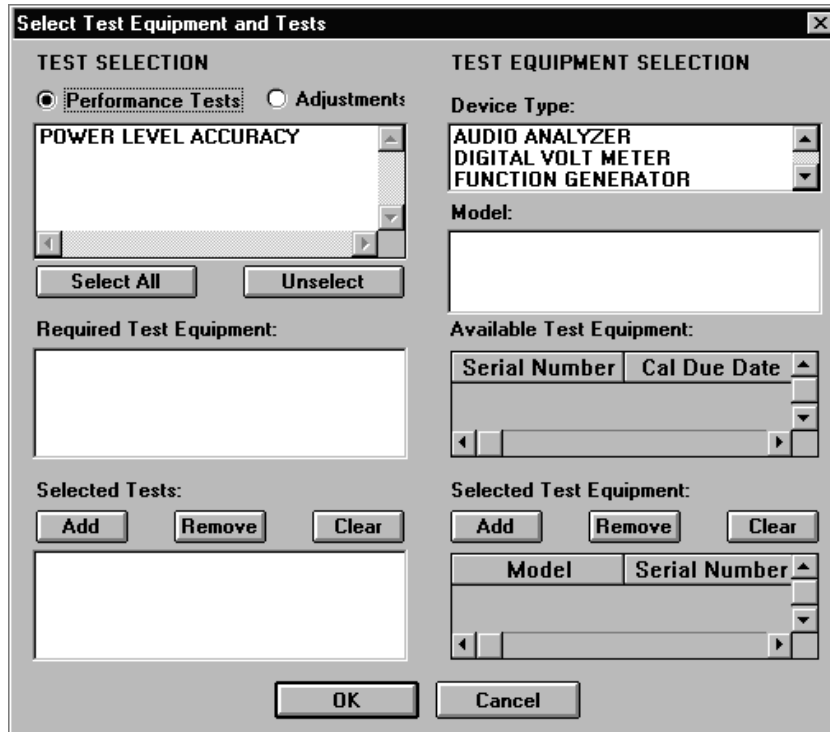

2. Select either the Performance Tests radio button to display the list of automated performance tests or the Adjustments radio button to display the list of automated adjustments.
3. From the list of performance tests or adjustments, select the tests or adjustments that you will perform on the DUT. Select the test name by clicking on it. The selected tests are highlighted.

You can select all of the performance tests or adjustments with the Select All button. You can unselect all of the selected tests or adjustments with the Unselect button.

As each test or adjustment is selected, the test equipment required to perform the test or adjustment is removed from the list. Only the test equipment for the highlighted tests is displayed in the list.

4. Once the tests are highlighted, identify all test equipment listed in the Required Test Equipment box. To identify a test equipment instrument:
 - a. Select the type of device from the Device Type list.
 - b. Select the model number from the Model list for the device.

- c. Select the device's serial number from the Available Test Equipment list.
- d. Select the Add button to add the device to the list in the Selected Test Equipment box.

The following buttons are available for the Selected Test Equipment box:

Add	Copies the test equipment highlighted in the Available Test Equipment box to the Selected Test Equipment box.
Remove	Removes the highlighted test equipment from the Selected Test Equipment box.
Clear	Removes all of the test equipment from the Selected Test Equipment box.

NOTE If necessary, the test equipment GPIB address can be changed after it is added to the Selected Test Equipment box. Change the GPIB address by pressing the right arrow on the keyboard until the GPIB Address selection in the Selected Test Equipment box is selected. The GPIB address is selected when it has a dark box around the selection. Then, type the new GPIB address and press Enter to change the address.

- e. Repeat the previous steps for each test equipment instrument.
5. Once the test equipment has been identified, select the Add button located above the Selected Tests box to add each of the highlighted tests or adjustments. The tests or adjustments that were highlighted are now displayed in the list in the Selected Tests box.

The following buttons are available for the Selected Tests box:

Add	Copies the test equipment highlighted in the list of tests and adjustments to the Selected Tests box.
Remove	Removes the highlighted tests and adjustments from the Selected Tests box.
Clear	Removes all of the tests and adjustments the Selected Tests box.

6. If the appropriate tests or adjustments are listed in the Selected Tests box and the appropriate test equipment is listed in the Selected Test Equipment box, select the OK button.

Saving the Test Results

1. When the Save As dialog box is displayed, select the File Name box and enter the desired name for the file.

The results file name suffix is log. The results are saved automatically to the log file. You may select the directory into which you would like to save the file by changing the drive and folder in this window. This file is a text file and can be viewed using many text editors.

2. Once you have selected the drive, folder, and assigned a file name, select the OK button to save these settings for when the tests are complete.

Running the Tests and Adjustments

1. In the Agilent Service Support Software main window, select the Run button to start the automated tests or adjustments displayed in the Selected tests box.

The software steps through the tests or adjustments sequentially.

2. Follow the instructions displayed on the PC.

Each automated adjustment is described in this chapter and the performance tests are described in Chapter 8.

Reviewing the Test and Adjustment Results

Once the tests have finished running, the Agilent Service Support Software main window displays the results:

Selected Tests: displays the name of the selected tests, the pass-fail status (P/F) of each test that has been run, the total number of points that each test checks, and the number of points that passed and failed for each test. The pass-fail status indicates a failure if any point in that test fails.

Selected Test

Results: shows the results of the test that is highlighted in the Selected Tests box. The Selected Test Results box shows the pass-fail status (P/F) the lower limits (LL), the measured value (Result), the upper limits (UL), and the measured units (for example, kHz, mV, or dBm) for each test point checked by the performance tests and some adjustments. "***" indicates values not displayed by the adjustments.

Current: shows the results of the test that is currently running, the pass-fail status (P/F), the lower limits (LL), the measured value (Result), the upper limits (UL), and the measured units (for example, kHz, mV, or dBm) for each test point checked by the performance tests and some adjustments. "***" indicates values not displayed by the adjustments.

The following buttons are also displayed on the Agilent Service Support Software main window. These buttons are used to control the testing. Only the buttons that are appropriate are active. For example, if the test is already in progress, the Run button would not be active.

Run: starts running the highlighted test when initially starting the testing or continues running the current test at the next data point after the testing was stopped.

Stop: stops the test that is currently running. The test stops after making the next measurements.

Restart: reruns a test that was running when the testing was stopped. This restarts the test from the beginning.

Next Test: quits running the current test and gives it a Fail status. Then, continues testing with the next test.

Rerun: restarts the testing at the beginning of the first test.

Abort: quits testing and aborts all tests

Printing the Test and Adjustment Results

Once the tests are complete, a dialog box asks if you want to print the log file. The log file contains the test and adjustment results. Choose Yes to print using the printer connected to LPT1. Choose No to exit the program without printing.

There are two other methods of printing the test results:

- Select Print from the File drop-down menu. The software asks you to define the computer path and file name where the tests were performed.

The default directory is the “log” subdirectory of the destination directory where you installed the software. (C:\hp-svc\Hp8648\ was the default destination directory.)

- Open the file in a text editor and print from the text editor.

Exiting the Software

Select Exit from the File drop-down menu or press Alt-F4.

Motherboard Repair Utility

Using the motherboard repair utility, you can:

- Enter the information required for changing the A3 motherboard to the PC and download that information to the controller portion of the motherboard.

As an example of its use, this utility should be used after changing the motherboard in an 8648 or after an option has been added.

CAUTION After information is downloaded to the motherboard, a complete calibration is required because calibration data is erased during the download.

- Read the instrument information that is stored in the 8648 motherboard.

This is a safe way to view the information stored in the motherboard. You do not run the risk of accidentally downloading information to the motherboard and causing the instrument to require a complete calibration. The information that this utility reads from the motherboard is:

- instrument serial number
- instrument model number
- attenuator part number and serial number (8648B/C/D only)
- options installed in the instrument

GPIB Address

In the HP8648 Motherboard Repair utility window, notice the three-digit GPIB address. The first digit is the bus number to which the GPIB card that is installed in the PC is set. The last two digits are the GPIB address to which the 8648 is set.

If the last two numbers do not match the actual address to which the 8648 is set, an I/O port error message is displayed.

This can be corrected by:

- Changing the actual 8648 GPIB address to match the last two digits displayed in the GPIB address entry in the HP8648 motherboard Repair Utility window:
 1. On the 8648, press **ADRS** and press the keys to match the last two digits of the GPIB address entry in the motherboard repair utility window.
 2. Click the OK button on the I/O Port Error.
- Changing the last two digits displayed in the GPIB address entry in the HP8648 Motherboard Repair Utility window to match the actual 8648 GPIB address:
 1. Click the Cancel button on the I/O Port Error.
 2. In the HP8648 Motherboard Repair Utility window, change the last two GPIB address digits to match the actual 8648 GPIB address.

Reading Information from the A3 Motherboard

This is a safe way to view the information stored in the motherboard. You do not run the risk of accidentally downloading information to the motherboard.

To read information from the A3 motherboard, follow these steps:

1. Open the HP8648 Motherboard Utility:
 - For MS Windows version 3.x:
 - a. Open the Program Manager window.
 - b. Open the Service Support program group.
 - c. Select the HP8648 Motherboard Utility icon.
 - For MS Windows 95, 98, NT:
 - a. Select Start.
 - b. Select Agilent Service Software for PC's.
 - c. Select HP8648 Motherboard Utility.
2. When the User Information dialog box requesting a password is displayed, leave the password box empty and select the Cancel button.
3. The HP8648 Motherboard Repair Utility window is displayed along with the following information that is stored in the motherboard:
 - instrument serial number (1)
 - instrument model number (2)
 - attenuator part number and serial number (3) (8648B/C/D only)
 - options installed (4)

HP8648 Motherboard Repair Utility

Please enter the HP-IB address to establish communication with the DUT

Enter the DUT current address: 719

Enter the desired Serial Number: 3538A01234

Enter the desired A11 Attenuator Numbers:
Last 4 digits of part number: 01234
5 digit Serial number: 012345678

Progress Indicator: ◆◆◆◆◆◆

Select the desired Model:
 HP8648A
 HP8648B
 HP8648C
 HP8648D

Select the installed Options:
 1E5 - HIGH STABILITY TIMEBASE
 1E6 - PULSE MODULATION
 1EA - HIGH POWER
 1EP - PAGER/ENCODER
 H01 - RF REMAINS IN SAME STATE
 1E2 - AUDIO OSCILLATOR

Get Data Send Data Cancel

- When you have finished reading the information stored in the motherboard, select the Cancel button to exit the program.

The Get Data button can be used if you are checking the data stored on additional motherboards.

Storing Information in the A3 motherboard

To store information to the A3 motherboard, follow these steps;

- Open the HP8648 Motherboard Utility:
 - For MS Windows version 3.x;
 - Open the Program Manager window.
 - Open the Service Support program group.
 - Select the HP8648 Motherboard Utility icon.
 - For MS Windows 95, 98, NT:
 - Select Start.
 - Select Agilent Service Software for PC's.
 - Select HP8648 Motherboard Utility.
- When the User Information dialog box requesting a password is displayed, type: 8648. Then select the OK button.
- The HP8648 Motherboard Repair Utility window is displayed so that the instrument information can be edited and stored in the motherboard. Refer to Figure ?. Edit the information in this window to reflect the actual changes.

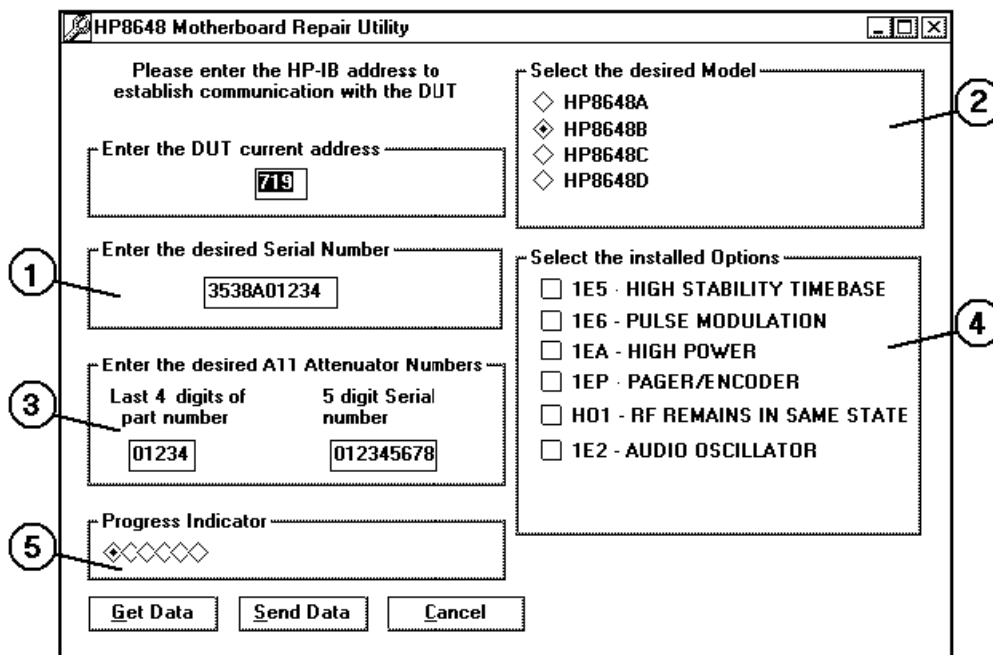

Instrument Serial Number (1): Enter the complete serial number of the instrument that has been changed.

Instrument Model Number (2): Select the model number of the instrument that has been changed. Only one model number may be selected.

Attenuator ID Number (3): For 8648B/C/D models only, enter the last four digits of the A11 attenuator serial number. For 8648A, these fields are given a default state of not applicable (N/A) and may not be changed.

Options Installed (4): Select all options that are actually installed in the instrument that has been changed. More than one may be selected. Any options that are not available with the instrument model number selected are grayed out and are not accessible. Select the correct instrument model number before selecting the options installed.

CAUTION Selecting options that are not actually installed in the instrument will cause erroneous information to be saved in the motherboard and will affect the instrument calibration.

CAUTION Once the Send Data button is selected, the download process is started and can not be stopped. Calibration data will be erased and a complete calibration will be required.

4. When you have finished entering the information for the instrument that has been changed, download it to the motherboard by selecting the Send Data button.
The download process can take several minutes to complete. A progress indicator will be displayed.
5. Once the information has been stored in the motherboard, select the Get Data button to read what is stored in the motherboard. If the information is not correct, repeat steps 3 and 4.
6. After the correct information has been stored in the motherboard, select Cancel to exit.

8 Performance Tests

The procedures in this chapter test the electrical performance of the signal generator. These tests do not require access to the interior of the instrument.

This chapter contains the following information:

- **Required Test Equipment List**

A list of all the equipment required to perform these manual performance tests. For a comprehensive list of all test equipment required to perform these tests plus the manual adjustments, and the automated adjustments and performance tests, see Chapter 5, “Service.”

- **Performance Tests**

The manual and automated performance tests required to verify the signal generator to its specifications. Most of these performance tests are performed manually, however, there is a single automated performance test.

The Power Level Accuracy performance test is the automated test. If this test is run, the RF level Accuracy performance test, one of the manual tests, does not need to be performed. The description for this automated performance test is located after the descriptions for the manual performance tests. Refer to “Service Support Software” in Chapter 7 “Adjustments” for information on using the service support software that runs this performance test.

- **Test Records**

A test record for each model of the 8648 is located at the end of this chapter. These test records are used to record the measurements for the manual performance tests. Keep these copies as masters and use a photocopy for each calibration.

See Chapter 4, “Specifications,” for the specifications for each 8648 model.

Calibration Cycle

The instrument requires periodic verification of performance. Under normal use and environmental conditions, an instrument should be calibrated every 2 years. Normal use is defined to be about 2,000 hours of use per year.

Required Test Equipment

- 8903B Option 051 Audio Analyzer
 - Distortion accuracy: ± 1 dB
 - Residual distortion: -80 dB at 80 kHz BW
 - 30 kHz low-pass filter
 - AC level accuracy: $\pm 4\%$
 - CCITT weighting filter
- 8902A Measuring Receiver
 - FM accuracy: $\pm 2\%$ of reading ± 1 digit
 - AM accuracy: $\pm 2\%$ of reading ± 1 digit
 - Range: 150 kHz to 1300 MHz
 - Filter: 300 Hz high-pass
 - Filter: 15 kHz low-pass
 - Detectors Peak+
- 8563E RF Spectrum Analyzer
 - Frequency range 1 MHz to 4000 MHz
 - Relative level accuracy: ± 2 dB
(harmonic and spurious measurements)
 - 100 Hz digital resolution BW filter (required for power accuracy)
 - Displayed average noise:
 - 100 kHz: -110 dBm
 - 1 MHz to 10 MHz: -130 dBm
 - 10 MHz to 4 BHz: -134 dBm
 - RF input VSWR: 1:1.5
 - External timebase input
- 8663A Synthesized Signal Generator
 - Frequency range: 11.5 MHz to 2500 MHz
 - Output level: ± 4 Hz at 4000 MHz
 - Meets 8663A single-sideband phase noise specifications

- 5350B Frequency Counter
 - Frequency range: 10 Hz to 20 GHz
 - Frequency accuracy: ± 4 Hz at 4000 MHz
(Includes reference accuracy and counter accuracy)
- MDC-174 RF Mizer (M/A Com Inc.)
 - Frequency range (RF and LO ports): 1 MHz to 2800 MHz
 - Frequency range (IF port): 1 MHz to 2000 MHz
 - Maximum input (LO port): +26 dBm
- MDC-164 RF Mizer (M/A Com Inc.) 8648C/D only
 - Frequency range (RF and LO ports): 500 MHz to 9000 MHz
 - Frequency range (IF port): 10 MHz to 2000 MHz
 - Maximum input (LO port): +24 dBm
- 438 Power Meter
 - Instrumentation accuracy: $\pm 0.5\%$
 - Power reference accuracy: 0.95
- 8481D Option H70 Power Sensor
 - Frequency range: 100 kHz to 4.2 GHz
 - Power range: -70 dBm to -20 dBm
 - Maximum SWR:
 - 100 kHz to 300 kHz: 1:1.2
 - 300 kHz to 2 GHz: 1:1.15
 - 2 GHz to 4.2 GHz: 1:1.4
 - Power linearity (-30 to -20 dBm): $\pm 1\%$
 - Cal factor accuracy: $\leq 1.6\%$
- 8482A Power Sensor
 - Frequency range: 100 kHz to 4.2 GHz
 - Power range: -30 dBm to +13 dBm
 - Maximum SWR:
 - 100 kHz to 300 kHz: 1:1.6
 - 300 kHz to 1 MHz: 1:1.12
 - 1 MHz to 2 GHz: 1:1.1
 - 2 GHz to 4.2 GHz: 1:1.1

- Cal factor accuracy (RSS): $\leq 1.6\%$
- 8491A/B Option 006 6dB Attenuator (no substitute)
- 8493A Option 010 10 dB Attenuator (no substitute)
- 11722A Sensor Module (no substitute)
- 8116A Pulse/Function Generator (for use with 8648B/C/D Option 1E6 only)
 - Frequency: 10 MHz
 - Duty cycle: 50%
 - Output: TTL square wave
- 54100A Oscilloscope (for use with 8648B/C/D Option 1E6 only)
 - Bandwidth: 1 GHz
- 5334B Option 010 Universal counter (for use with 8648A Option 1EP only)
 - Frequency accuracy: ± 2 millihertz at 1600 Hz
- 89441A Vector Signal Analyzer with Options AYB and UFG (for use with 8648A Option 1EP only)
 - FSK deviation accuracy: ± 10 Hz at 4800 Hz deviation
- 54600B Oscilloscope (for use with 8648 Option 1E5 only)
 - Bandwidth: 100 MHz
- 5071A Primary Frequency Standard (for use with 8648 Option 1E5 only)
 - Frequency: 10 Mhz
 - Stability: $> 1 \times 10^{-10}/\text{year}$
- 5316B Frequency Counter
 - Resolution: 0.1 hz
- 8447D Low Frequency Amplifier
 - Frequency range: 100 kHz to 1300 MHz
 - Gain (mean, per channel): ≥ 25 dB
 - Noise figure: ≤ 8.5 dB
- 8449B High Frequency amplifier
 - Frequency range: 1300 MHz to 4 GHz
 - Gain (mean, per channel): ≥ 26 dB
 - Noise figure: ≤ 8.5 dB

Performance Test Descriptions

The performance test verify the signal generator meets its specifications. The following tests are documented in this section:

Manual Performance Tests

- FM Accuracy
- FM Accuracy (Option 1E2 Only)
- FM distortion
- AM Accuracy
- AM Accuracy (Option 1E2 Only)
- AM Distortion
- Phase Modulation Distortion
- Residual FM
- harmonics
- Spurious
- DC FM Frequency Error
- RF Level Accuracy
- Pulse Modulation On/Off Ratio (Option 1E6 Only)
- Pulse Modulation Rise Time (Option 1E6 Only)
- Pager Encoder Timebase Accuracy (Option 1EP Only)
- FSK Deviation Accuracy (Option 1EP Only)
- Internal Timebase: Aging Rate (Option 1E5 Only)

Automated Performance Tests

- Power Level Accuracy

FM Accuracy Performance Test

Connect the Test Equipment

Figure 8-1. FM Accuracy Equipment Setup

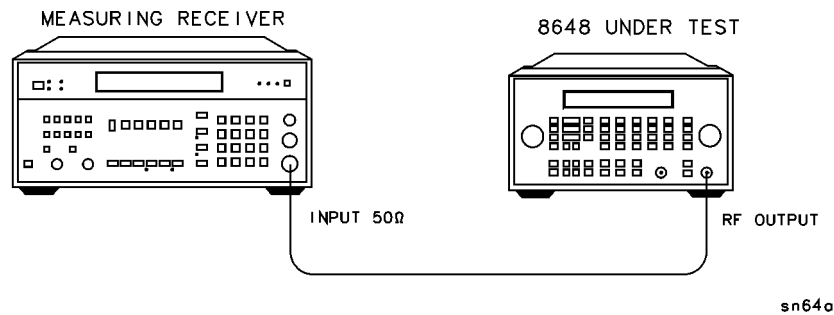

Configure the Measuring Receiver

1. Reset
2. FM mode
3. Peak+ detector
4. 300 Hz high-pass filter
5. 15 khz low-pass filter

Configure the 8648

1. Turn FM on; press **FM MOD ON/OFF**.
2. Set the rate; press **INT 1 Khz**.
3. Set the amplitude; press **AMPLITUDE 4 dB(m)**.
4. Turn the RF output on; press **RF ON/OFF**.

Measure Deviations

1. Enter the frequencies and deviations shown in the test record.
2. Record the test results and compare the results to the limits in the test record.

Test Record

- 8648A: [Table 8-5](#).
- 8648B: [Table 8-22](#).
- 8648C: [Table 8-47](#).
- 8648D: [Table 8-72](#).

8648B/C/D Only

The following steps are for the 8648B/C/D only. For the 8648A, this performance test is concluded.

Connect the Test Equipment

Figure 8-2. FM Accuracy equipment Setup for 8648B/C/D

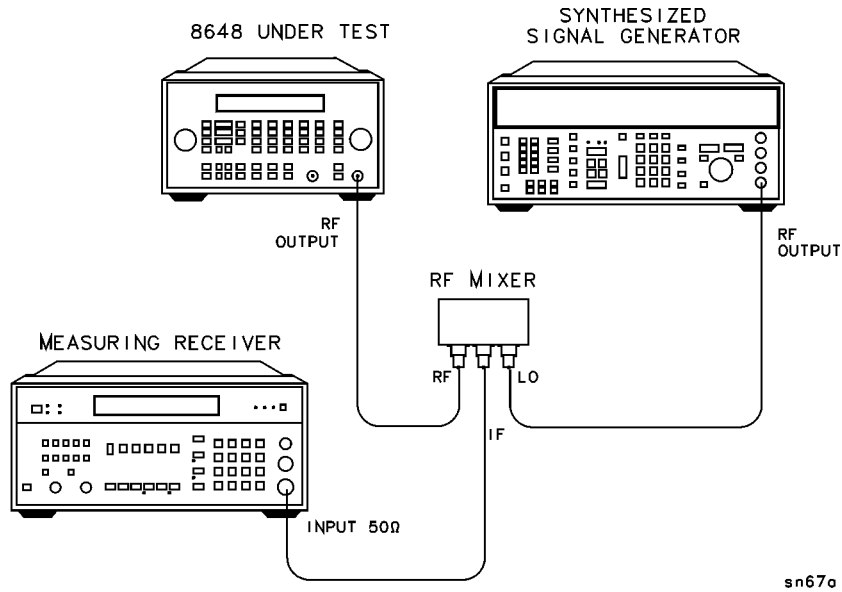

NOTE Use RF mixer MDC-164 when testing the 8648C/D. When testing the 8648B, either RF mixer MDC-174 or MDC-164 may be used.

Configure the Synthesized Signal Generator

1. Amplitude +16 dBm
2. Frequency CW (LO frequencies on test record)
3. Modulation off

Measure Deviations

1. Enter the frequencies and deviations shown in the test record.
2. Record the test results and compare the results to the limits in the test record.

Test Record

- 8648B: [Table 8-23.](#)
- 8648C: [Table 8-48.](#)
- 8648D: [Table 8-73.](#)

FM Accuracy Performance Test (Option 1E2 Only)

Connect the Test Equipment

Figure 8-3. FM Accuracy Equipment Setup for Option 1E2

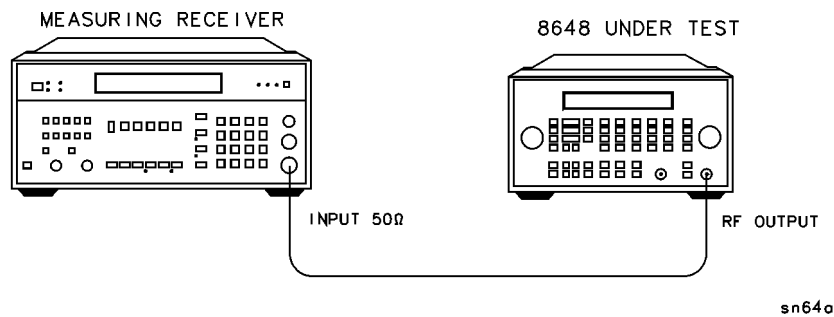

Configure the Measuring Receiver

1. Reset
2. FM mode
3. peak+ detector
4. 300 Hz high-pass filter
5. 15 kHz low-pass filter

Configure the 8648

1. Turn FM on; press **FM MOD ON/OFF**.
2. Press **INT 1 kHz** until the modulation generator (Option 1E2) sine waveform is activated.
3. Set the rate; press **1 kHz**.
4. Set the amplitude; press **AMPLITUDE 4 dB(m)**.
5. Turn the RF output on; press **RF ON/OFF**.

Measure Deviations

1. Enter the frequencies and deviations shown in the test record.
2. Record the test results and compare the results to the limits in the test record.

Test Record

- 8648A: [Table 8-6.](#)
- 8648B: [Table 8-24.](#)
- 8648C: [Table 8-49.](#)
- 8648D: [Table 8-74.](#)

8648B/C/D Option 1E2 Only

The following steps are for the 8648b/C/D with Option 1E2 only. For the 8648A, this performance test is concluded.

Connect the Test Equipment

Figure 8-4. FM Accuracy Equipment Setup for 8648B/C/D Option 1E2

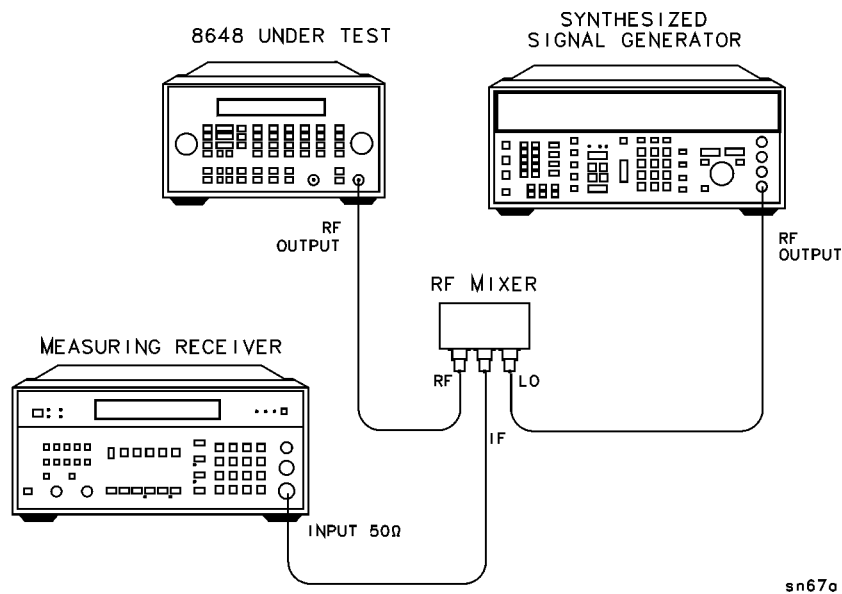

NOTE Use RF mixer MDC-164 when testing the 8648C/D. When testing the 8648B, either RF mixer MDC-174 or MDC-164 may be used.

Configure the Synthesized Signal Generator

1. Amplitude +16 dBm
2. Frequency CW (LO frequencies on test record)
3. Modulation off

Measure Deviations

1. Enter the frequencies and deviations shown in the test record.
2. Record the test results and compare the results to the limits in the test record.

Test Record

- 8648B: [Table 8-25.](#)
- 8648C: [Table 8-50.](#)
- 8648D: [Table 8-75.](#)

FM Distortion Performance Test

Connect the Test Equipment

Figure 8-5. FM Distortion Equipment Setup

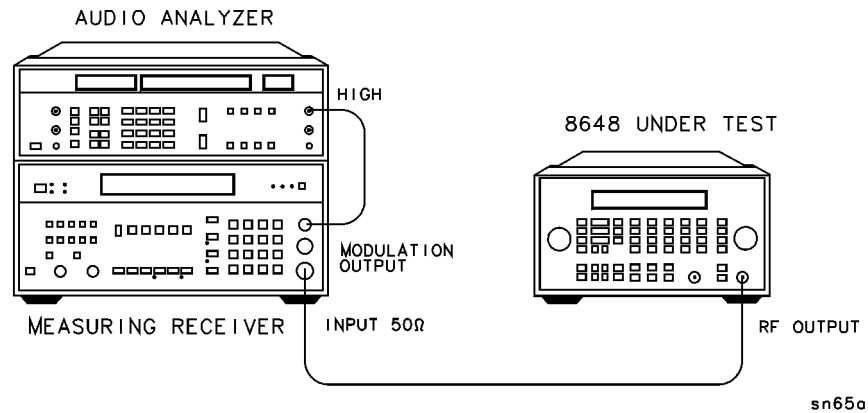

Configure the Measuring Receiver

1. Reset
2. FM mode
3. Peak+ detector
4. 300 Hz high-pass filter
5. 15 kHz low-pass filter

Configure the Audio Analyzer

1. Distortion mode
2. 30 kHz low-pass filter

Configure the 8648

1. Turn FM on; press **FM MOD ON/OFF**.
2. Set the rate; press **INT 1 kHz**.
3. Set the amplitude; press **AMPLITUDE 4 dBm**.
4. Turn the RF output on; press **RF ON/OFF**.

Measure Distortion

1. Enter the frequencies and deviations shown in the test record.
2. Record the test results and compare the results with the limits in the test record.

Test Record

- 8648A: [Table 8-7.](#)
- 8648B: [Table 8-26.](#)
- 8648C: [Table 8-51.](#)
- 8648D: [Table 8-76.](#)

8648B/C/D Only

The following steps are for the 8648B/C/D only. For the 8648A, this performance test is concluded.

Connect the Test Equipment

Figure 8-6. FM Distortion Equipment Setup

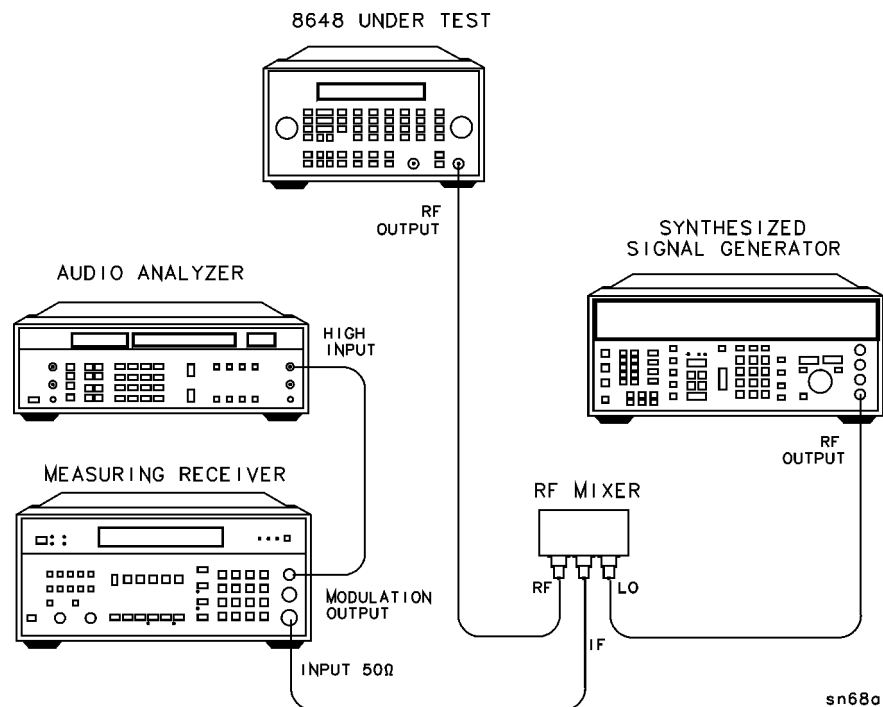

NOTE Use RF mixer MDC-164 when testing the 8648C/D. When testing the 8648B, either RF mixer MDC-174 or MDC-164 may be used.

Configure the Synthesized Signal Generator

1. Amplitude +16 dBm
2. Frequency CW (LO frequencies on test record)
3. Modulation off

Measure Deviations

1. Enter the frequencies and deviations shown in the test record.
2. Record the test results and compare the results with the limits in the test record.

Test Record

- 8648B: [Table 8-27](#).
- 8648C: [Table 8-52](#).
- 8648D: [Table 8-77](#).

AM Accuracy Performance Test

Connect the Test Equipment

Figure 8-7. AM Accuracy Equipment Setup

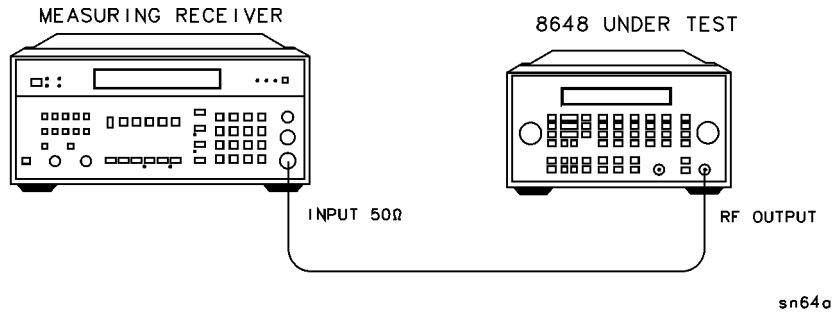

Configure the Measuring Receiver

1. Reset
2. AM mode
3. Peak+ detector
4. 300 Hz high-pass filter
5. 15 kHz low-pass filter

Configure the 8648

1. Turn AM on; press **AM MOD ON/OFF**.
2. Set the rate; press **INT 1 kHz**.
3. Turn the RF output on; press **RF ON/OFF**.

Measure Depths

1. Enter the amplitudes, frequencies and depths shown in the test record.
2. Record the test results and compare the results to the limits in the test record.

Test Record

- 8648A: [Table 8-8](#).
- 8648B: [Table 8-28](#).
- 8648C: [Table 8-53](#).
- 8648D: [Table 8-78](#).

AM Accuracy Performance Test (Option 1E2 Only)

Connect the Test Equipment

Figure 8-8. AM Accuracy Equipment Setup for Option 1E2

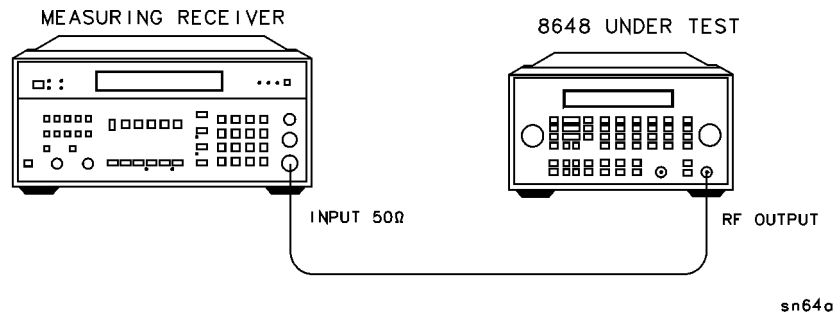

Configure the Measuring Receiver

1. Reset
2. AM mode
3. Peak+ detector
4. 300 Hz high-pass filter
5. 15 kHz low-pass filter

Configure the 8648

1. Turn AM on; press **AM MOD ON/OFF**.
2. Press **INT 1 kHz** until the modulation generator (Option 1E2) sine waveform is activated.
3. Set the rate; press **1 kHz**.
4. Turn the RF output on; press **RF ON/OFF**.

Measure Depths

1. Enter the amplitudes, frequencies and depths shown in the test record.
2. Record the test results and compare the results to the limits in the test record.

Test Record

- 8648A: [Table 8-9.](#)
- 8648B: [Table 8-29.](#)
- 8648C: [Table 8-54.](#)
- 8648D: [Table 8-79.](#)

AM Distortion Performance Test

Connect the Test Equipment

Figure 8-9. AM Distortion Equipment Setup

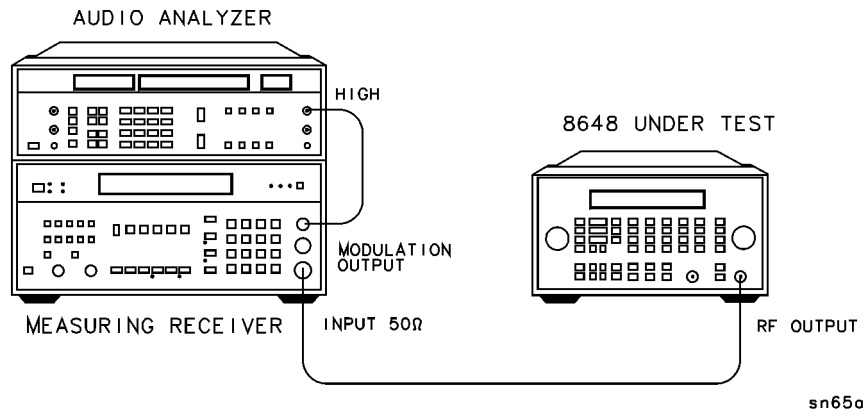

Configure the Measuring Receiver

1. Reset
2. AM mode
3. Peak+ detector
4. 300 Hz high-pass filter
5. 15 kHz low-pass filter

Configure the Audio Analyzer

1. Distortion mode
2. 30 kHz low-pass filter
3. Set low input to ground

Configure the 8648

1. Turn AM on; press **AM MOD ON/OFF**.
2. Set the rate; press **INT 1 kHz**.
3. Set the amplitude; press **AMPLITUDE 4 dB(m)**.
4. Turn the RF output on; press **RF ON/OFF**.

Measure Distortion Amplitudes

1. Enter the amplitudes, frequencies and depths shown in the test record.
2. Record the test results and compare the results to the limits in the test record.

Test Record

- 8648A: [Table 8-10.](#)
- 8648B: [Table 8-30.](#)
- 8648C: [Table 8-55.](#)
- 8648D: [Table 8-80.](#)

Phase Modulation Distortion Performance Test

Connect the Test Equipment

Figure 8-10. Phase Modulation Distortion Equipment Setup

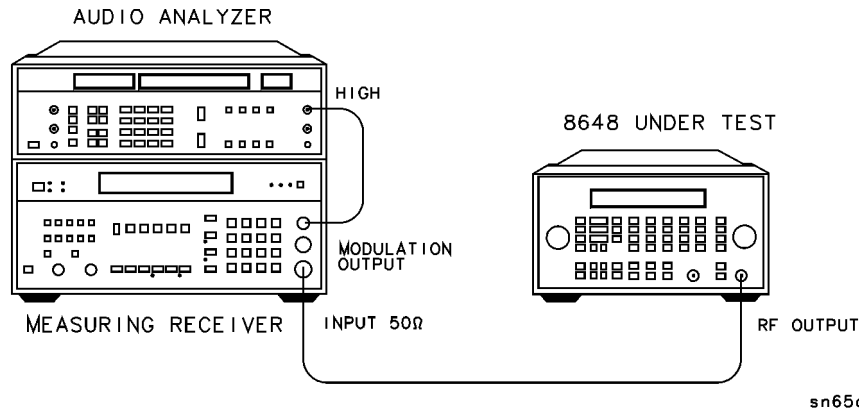

Configure the Measuring Receiver

1. Reset
2. Φ M mode
3. Peak+ detector
4. 300 Hz high-pass filter
5. 15 kHz low-pass filter

Configure the Audio Analyzer

1. Distortion mode
2. 30 kHz low-pass filter
3. Set low input to ground

Configure the 8648

1. Turn Φ M on; press Φ MOD ON/OFF.
2. Set the rate; press INT 1 kHz.
3. Set the amplitude; press AMPLITUDE 4 dB(m).
4. Turn the RF output on; press RF ON/OFF.

Measure Distortion

1. Enter the frequencies and deviations shown in the test record.
2. Record the test results and compare the results to the limits in the test record.

Test Record

- 8648A: [Table 8-11.](#)
- 8648B: [Table 8-31.](#)
- 8648C: [Table 8-56.](#)
- 8648D: [Table 8-81.](#)

8648B/C/D Only

The following steps are for the 8648B/C/D only. For the 8648A, this performance test is concluded.

Connect the Test Equipment

Figure 8-11. Phase Modulation Distortion Equipment Setup for 8648B/C/D

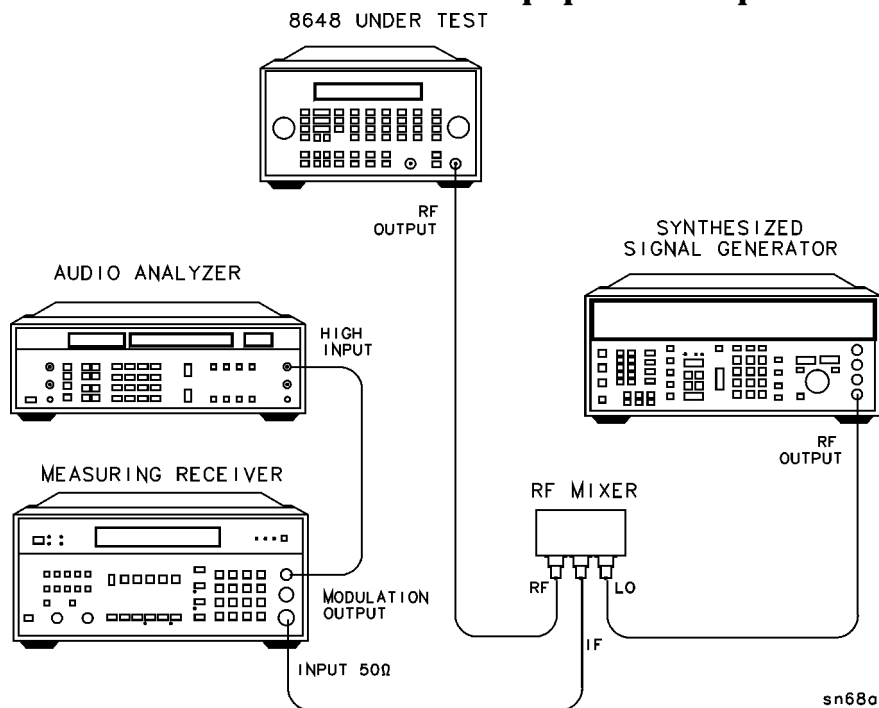

NOTE

Use RF mixer MDC-164 when testing the 8648C/D. When testing the 8648B, either RF mixer MDC-174 or MDC-164 may be used.

Configure the Synthesized Signal Generator

1. Amplitude +16 dBm
2. Frequency CW (LO frequencies on test record)
3. Modulation off

Measure Deviations

1. Enter the frequencies and deviations shown in the test record.
2. Record the test results and compare the results to the limits in the test record.

Test Record

- 8648B: [Table 8-32.](#)
- 8648C: [Table 8-57.](#)
- 8648D: [Table 8-82.](#)

Residual FM Performance Test

Connect the Test Equipment

Figure 8-12. Residual FM Equipment Setup

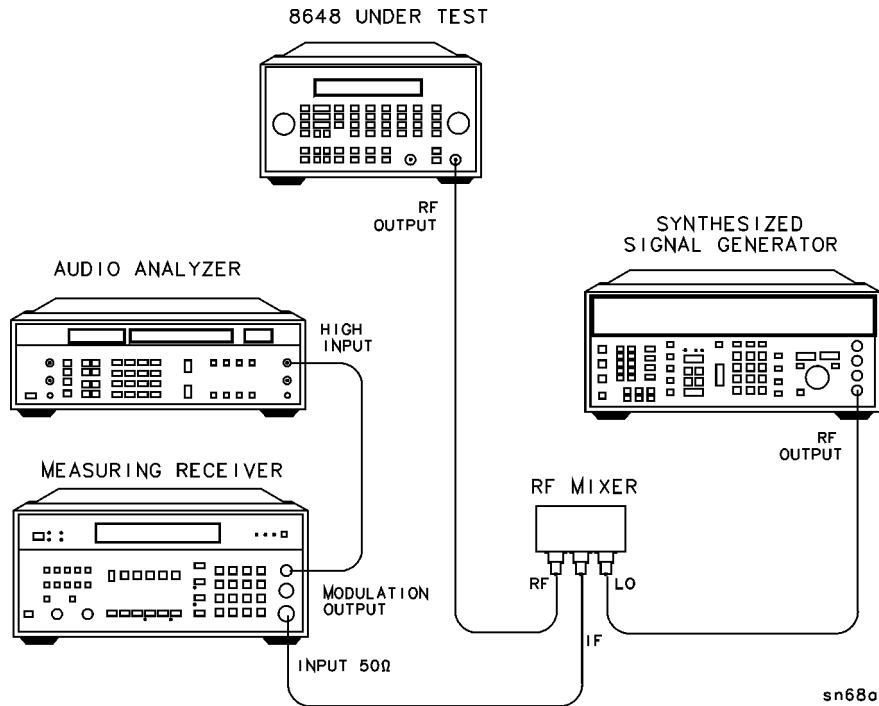

NOTE Use RF mixer MDC-174 when testing the 8648A/B/C. When testing the 8648D, both RF mixer MDC-174 and MDC-164 are required.

Configure the Measuring Receiver

1. Reset
2. FM mode
3. Peak+ detector
4. 50 Hz high-pass filter
5. 15 kHz low-pass filter

Configure the Audio Analyzer

1. AC level mode
2. CCITT weighting filter
3. 30 kHz low-pass filter
4. Set low input to ground

Configure the Synthesized Signal Generator

1. Amplitude +16 dBm
2. Frequency CW (LO frequencies on test record)
3. Modulation off

Configure the 8648

1. Turn modulation off; press **MOD ON/OFF**.
2. Set the amplitude; press **AMPLITUDE 4 dB(m)**.
3. Turn the RF output on; press **RF ON/OFF**.

Measure Deviations

1. Enter the frequencies shown in the test record.
2. Record the test results and compare the results to the limits in the test record.

NOTE The voltage displayed by the audio analyzer can be read as Hz. For example, 10 mV equals 10 Hz.

Test Record

- 8648A: [Table 8-12.](#)
- 8648B: [Table 8-33.](#)
- 8648C: [Table 8-58.](#)
- 8648D: [Table 8-83.](#)

Harmonics Performance Test

Connect the Test Equipment

Figure 8-13. Harmonics Equipment Setup

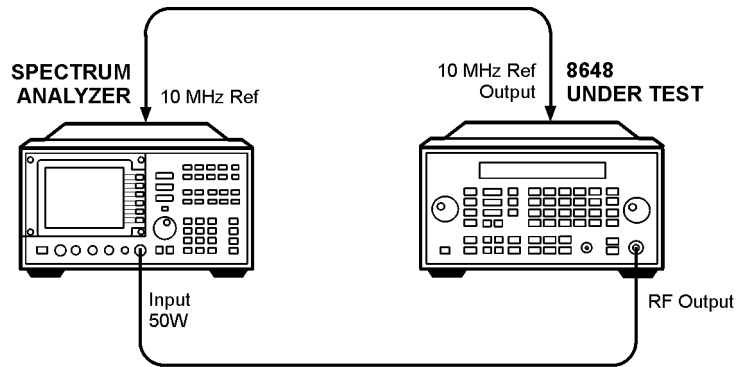

an626a2d

Configure the Spectrum Analyzer

1. Frequency span 500 kHz
2. Resolution BW 10 kHz
3. Video BW 30 kHz

Configure the 8648

1. Turn the RF output on; press **RF ON/OFF**.
2. Turn the modulation off; press **MOD ON/OFF**.
3. Set the amplitude; press **AMPLITUDE 4 dB(m)**.

Measure Harmonic Levels

1. Measure the level of the 2nd, 3rd, and 1/2 harmonics shown in the test record.
2. Convert the harmonic level to decibels below the fundamental (dBc) and compare the results to the corresponding limits.

Test Record

- 8648A: [Table 8-13](#).
- 8648B: [Table 8-34](#).
- 8648C: [Table 8-59](#).
- 8648D: [Table 8-84](#).

Spurious Performance Test

Connect the Test Equipment

Figure 8-14. Spurious Equipment Setup

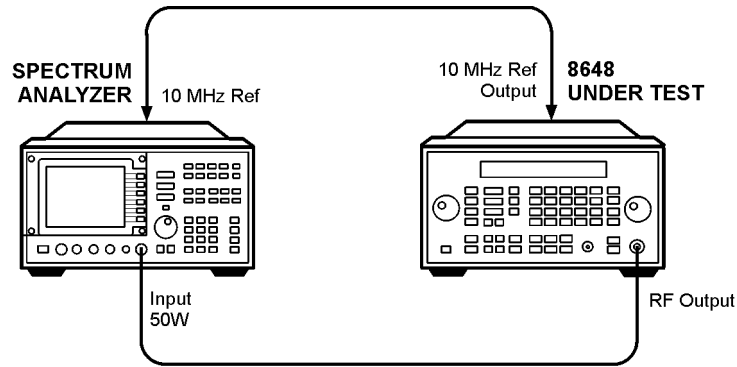

an626a2d

Configure the Spectrum Analyzer

1. Frequency span 500 kHz
2. Resolution BW 1 kHz
3. Video BW 1 kHz

Configure the 8648

1. Turn the RF output on; press **RF ON/OFF**.
2. Turn modulation off; press **MOD ON/OFF**.

Measure Spurious Levels

1. Measure the levels of the spurious signals shown in the test record.
2. Convert the measured levels to decibels below the fundamental (dBc) and compare the results to the corresponding limits.

Test Record

- 8648A: [Table 8-14](#).
- 8648B: [Table 8-35](#).
- 8648C: [Table 8-60](#).
- 8648D: [Table 8-85](#).

DC FM Frequency Error Performance Test

Connect the Test Equipment

Figure 8-15. DC FM Frequency Error Equipment Setup

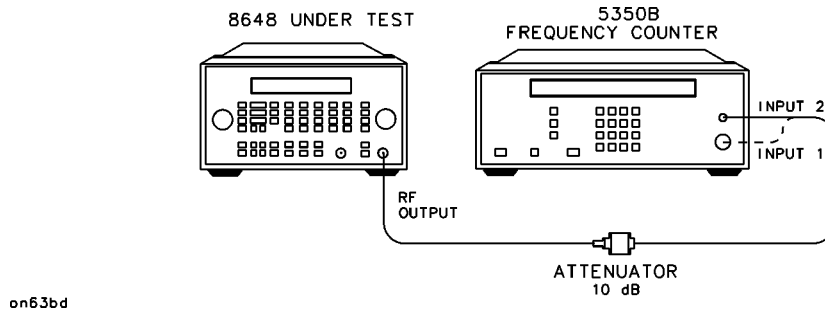

Configure the Frequency Counter

- For frequencies > 10 MHz and < 500 MHz:
Use Input 2; press 50Ω.
- For frequencies > 500 MHz:
Use Input 1; press AUTO.

Configure the 8648

1. Set the amplitude; press AMPLITUDE 4 dB(m).
2. Select external DC FM; press FM EXT DC.
3. Press RF ON/OFF to turn the RF output on.
4. Turn on MOD ON/OFF.
5. Press EXT DC to perform DC FM calibration.

Measure Deviations

1. Set the frequencies and deviations shown in the test record.
2. For each data point, measure the carrier frequency with FM turned off, press MOD ON/OFF.
3. For each data point, measure the carrier frequency with FM turned on, press MOD ON/OFF.
4. Compute the error (difference) and compare it to the corresponding limits.

Test Record

- 8648A: [Table 8-15.](#)
- 8648B: [Table 8-36.](#)
- 8648C: [Table 8-61.](#)
- 8648D: [Table 8-86.](#)

RF level Accuracy Performance Test

NOTE This performance test is an adequate substitute for the automated Power Level Accuracy performance test. If the *preferred* Power Level Accuracy performance test is performed, this performance test is not required.

Description

This power accuracy verification procedure directly measures the full performance of the 8648A.

For the 8648B/C/D, direct measurements can only be made over the full dynamic range up to 1300 MHz. The measuring receiver verifies the operation of the ALC and step attenuator over its full dynamic range, 13 dBm to -127 dBm for frequencies less than 1300 MHz.

Two power meters are used to verify operation at frequencies greater than 1300 MHz down to -60 dBm.

Historically, testing of the 8648B/C/D demonstrates that low-level performance at frequencies less than 1300 MHz is indicative of low-level performance at greater than 1300 MHz.

Connect the Test Equipment

Figure 8-16. Equipment Setup for 8648A and 8648B/C/D \leq 1300 MHz

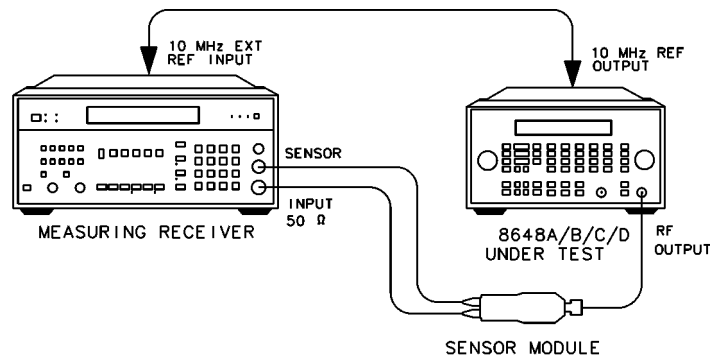

on62bd

Configure the Measuring Receiver

1. Reset
2. RF power mode (tuned RF level mode for levels lower than -10 dBm)
3. Connect the measuring receiver and 8648 timebases.
4. Set to measure in dBm; press **LOG/LIN**.

NOTE Enter the power sensor's calibration data into the measuring receiver and zero the sensor module. Refer to the measuring receiver's operating manual.

Configure the 8648

1. Turn the RF output on; press **RF ON/OFF**.
2. Turn modulation off; press **MOD ON/OFF**.

Measure Amplitudes

1. For each frequency the measuring receiver must be calibrated for tuned-RF-level operation.
2. Set the frequency and amplitude shown in the test record.
3. Measure the amplitude shown in the test record.
4. Record the test results and compare the results to the limits in the test record.

Test Record

- 8648A: [Table 8-16](#).
- 8648B: [Table 8-37](#).
- 8648C: [Table 8-62](#).
- 8648D: [Table 8-87](#).

8648B/C/D Only

The following steps are for the 8648B/C/D only. For the 8648A, this performance test is concluded.

Connect the Test Equipment

Figure 8-17. Equipment Setup for 8648B/C/D > 1300 MHz

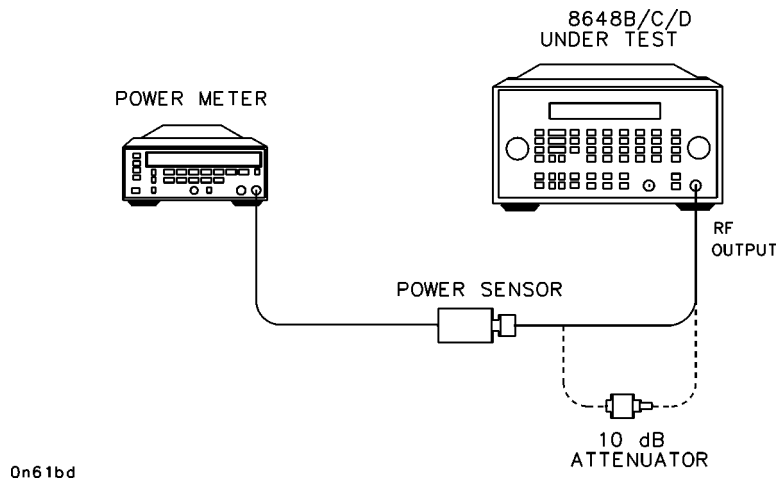

Configure the Power Meter

1. Connect the 8482A power sensor to the power meter.
2. Connect the power sensor to the power meter POWER REF output.
3. Zero and calibrate the power meter.

Configure the 8648B/C/D

1. Connect the power sensor to the 8648 RF OUTPUT connector.
2. Set the amplitude; press **AMPLITUDE 13 dB(m)**.
3. Turn the RF output on; press **RF ON/OFF**.

Measure High Level Power Accuracy (≤ 13 dBm)

1. Enter the frequencies and power levels shown in the test record. Make sure the power sensor cal factors are entered correctly for each frequency. Do not test below -20 dBm with this test setup.
2. Record the test results and compare the results to the limits in the test record.

Test Record

- 8648B: [Table 8-38](#).
- 8648C: [Table 8-63](#).
- 8648D: [Table 8-88](#).

NOTE For 8648B/C/D instruments without Option 1EA, high power, skip ahead to “Configure the Power Meter”. All others, continue with the next step.

Configure the 8648 Option 1EA

1. Set the amplitude; press **AMPLITUDE 10 dB(m)**.
2. Turn the Rf output on; press **RF ON/OFF**.
3. Connect the power sensor directly to the 8648 RF OUTPUT connector.

Measure the High Power Level Accuracy

1. measure the RF power at each frequency listed in [Table 8-1](#) and record the measurement in the first row of the table.
2. Connect the 10 dB attenuator between the 8648 RF OUTPUT connector and the power sensor.
3. Measure the RF power at each frequency listed in [Table 8-1](#) and record the measurement in the second row of the table.
4. Calculate the actual attenuator value for each frequency (the difference between the two measurements) and record it in the third row of the table.
5. For each frequency listed in [Table 8-1](#) set the 8648 amplitude to the level shown in the table and measure the RF power level through the 10 dB attenuator. Record the measurement in the fifth row of the table.
6. Calculate the actual output power for each frequency (the sum of the measured power and the attenuator value) and record it in the test record.

Table 8-1 High Power Level Accuracy Work Table

Frequency (MHz)	3.0	249.9	400	999.9	1500	2100	2500	3200	4000
Power without 10 dB Attenuator									
Power with 10 dB Attenuator									
Attenuator Value									
Amplitude Setting (dBm)	20	20	20	20	19	17	15	13	13
Measured Power									
Actual Output Power									

7. Record the test results and compare the results to the limits in the test record.

Test Record

- 8648B: [Table 8-39](#).
- 8648B with Options 1EA and 1E6: [Table 8-40](#).
- 8648C: [Table 8-64](#).
- 8648C with Options 1EA and 1E6: [Table 8-65](#).
- 8648D: [Table 8-89](#).
- 8648D with Options 1EA and 1E6: [Table 8-90](#).

Configure the Power Meter

1. Connect the 8481D Option H70 power sensor to the power meter.
2. Connect the power sensor through the 11709A 30 dB attenuator to the power meter Power Ref output.
3. Zero and calibrate the power meter.

Measure Low Level Power accuracy (< -20 dBm)

1. Connect the power sensor to the 8648 RF OUTPUT connector.
2. Enter the frequencies and power levels shown in the test record. Make sure the power sensor cal factors are entered correctly for each frequency. Do not test at levels > -20 dBm with this test setup.
3. Record the test results and compare the results to the limits in the test record.

Test Record

- 8648B: [Table 8-41](#).
- 8648C: [Table 8-66](#).
- 8648D: [Table 8-91](#).

Pulse Modulation On/Off Ratio Performance Test (Option 1E6 Only)

Connect the Test Equipment

Figure 8-18. Pulse Modulation On/Off Ratio Equipment Setup

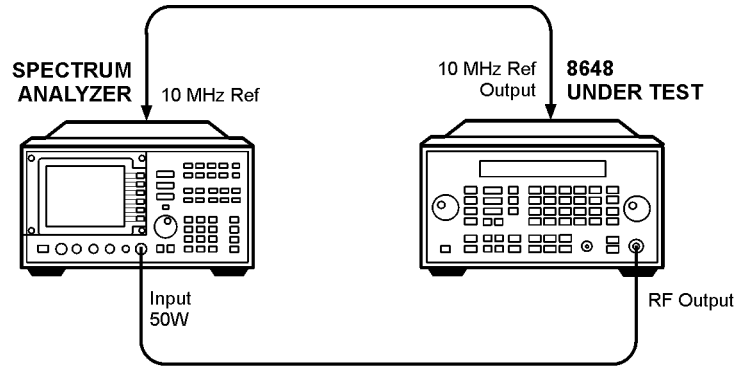

an626a2d

Configure the Spectrum Analyzer

1. Resolution BW 10 kHz
2. video BW 1 MHz
3. Frequency span 0 Hz
4. Reference level 0 dBm
5. Scale 10 dB/div
6. Video trigger

Configure the 8648

1. Turn the RF output on; press **RF ON/OFF**.
2. Set the amplitude; press **AMPLITUDE 0 dB(m)**.
3. Activate pulse modulation display; press **AM AM**.
4. Turn pulse modulation on; press **MOD ON/OFF**.

Measure the On/Off Ratio

1. Set the frequencies of the spectrum analyzer and the 8648 to those listed in the test record. For each frequency, measure the change in amplitude as the RF is pulsed on and off. (Press **MOD ON/OFF**.)
2. Record the text results and compare the results to the limits in the test record.

Test Record

- 8648B: [Table 8-42](#).
- 8648C: [Table 8-67](#).
- 8648D: [Table 8-92](#).

Pulse Modulation Rise Time Performance Test (Option 1E6 Only)

Connect the Test Equipment

Figure 8-19. Pulse Modulation On/off Risetime Equipment Setup

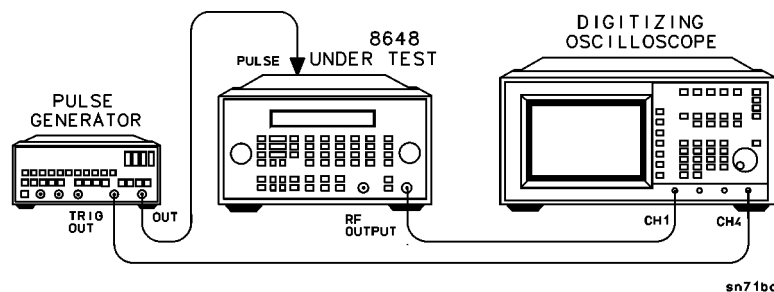

Configure the Pulse Generator

1. Mode normal
2. Frequency 10 Mhz
3. Duty cycle 50%
4. Amplitude 1 V
5. Offset 1 V

Configure the 8648

1. Turn the RF output on; press **RF ON/OFF**.
2. Activate pulse modulation display; press **AM AM**.
3. Turn pulse modulation on; press **MOD ON/OFF**.
4. Set the amplitude; press **AMPLITUDE 0 dB(m)**.

Configure the Oscilloscope

1. Channel 1 125 mV/div
2. Trigger source channel 4
3. Trigger level 1.5 V
4. Timebase 10 ns/div

Measure the Rise Time

1. Use the timebase delay to align a rising pulse edge with the center of the oscilloscope screen.
2. Change the timebase to 2 ns/div.
3. Display the envelope of channel 1.
4. Set the frequency of the 8648 to that listed in the test record. For this frequency measure the 10% to 90% rise time of the RF pulse.

Test Record

- 8648B: [Table 8-43](#).
- 8648C: [Table 8-68](#).
- 8648D: [Table 8-93](#).

Pager Encoder Timebase Accuracy Performance Test (Option 1EP Only)

Connect the Test Equipment

Figure 8-20. Pager Encoder Timebase Accuracy Equipment Setup

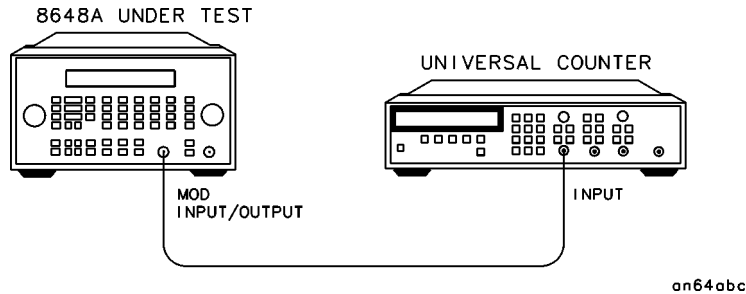

Configure the Frequency Counter

1. Frequency Auto
2. Input 1 M Ω

Configure the 8648

1. Enter the pager encoder mode by pressing **FM (ENCODER)** twice. (If FM was the last active function, only press the **FM (ENCODER)** key once.)
2. Rotate the **AMPLITUDE/ENCODER** knob to set **FORMAT** to **SERVICE**.
3. Press \downarrow (**NEXT**) and rotate the **AMPLITUDE/ENCODER** knob to set **CALIBRATION FSK** to **3200/2**.
4. Press **INCR SET (START/STOP)** to turn the encoder output on.

Measure the Frequency

1. Record the test results and compare the results to the limits in the test record.

Test Record

- 8648A Option 1EP: [Table 8-17](#).

FSK Deviation Accuracy Performance Test (Option 1EP Only)

Connect the Test Equipment

Figure 8-21. FM Deviation Accuracy Equipment Setup

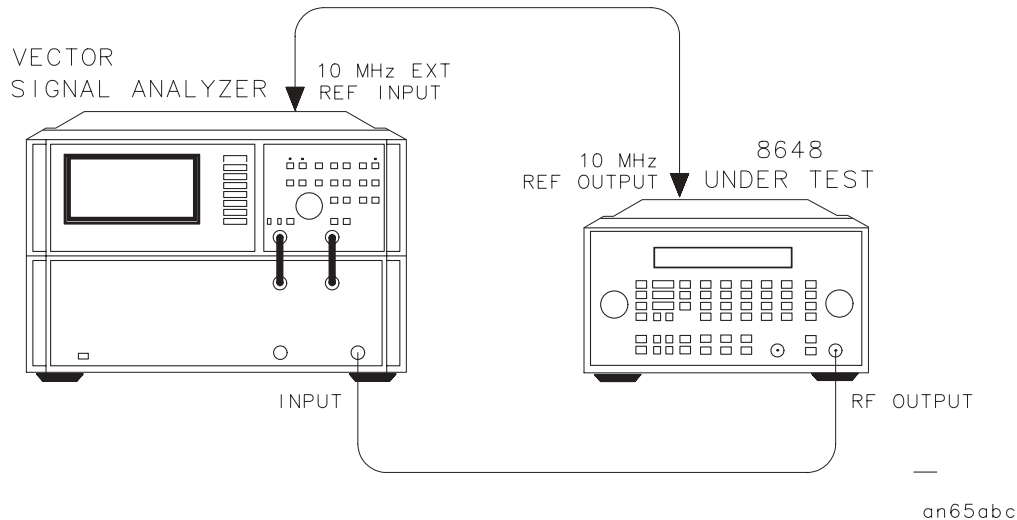

Configure the Vector Signal Analyzer

1. Set the instrument mode; press:
 - a. Instrument Mode, Digital Demodulation
 - b. demodulation setup, demod format, FSK 2 (or FSK 4), Return
 - c. symbol rate, 1.6 (or 3.2), kHz
 - d. result length, 10, sym
 - e. meas filter, Low Pass, Return
 - f. ref filter, rect, Return
 - g. more, normalize off

NOTE The symbol rate must be set to 1.6 kHz for 1200/2 FSK and 3.2 kHz for 6400/4 FSK.

2. Set the display mode, press: **Display, 4 grids quad.**

3. Set each channel trace mode:

Channel	Measurement Data	Data Format
A	FSK measured time	polar (IQ) vector
B	FSK error time	magnitude linear
C	FSK measured time	eye diagram I
D	symbol table/error summary	

4. Set the average mode, press: **Average, average off.**

5. Set the frequency span (the frequency span must be set to 20 kHz for 1200/2 FSK and 50 kHz for 6400/4 FSK), press:

Frequency, center, 155, MHz, Span, 20 (or 50), kHz

6. Set the time mode, press:

Time, result length, 100, sym

sync search on, sync setup, pattern, 01, enter, Return

points/symbol, 20, enter

7. Set the trigger mode to single mode, press: **Pause/Single**

8. Couple **Mkrs** on.

9. Display the status, press: **View State, measurement state**

The status should look like the following:

Inst	Digital Demodulation	Channels	2	
Mode	Meas from input	Receiver	RF 2650 MHz	
	Format	2 FSK	Rate	1.2 kHz
	Alpha	0.05	Meas filter	Low Pass
	Normalize	off	Ref filter	rect
	Clk Adj	0 sym		
Freq	Span	20 kHz	Center	155 MHz
Bw/Win	Rbw	300 kHz	Window	flat top
Time	Puls-srch	off	Sync-srch	on
	Pts/sym	20	Srch	---ms
	Result	10 sym	Sync offset	0 sym
Average	Status	off	Num averages	10 (Avg Off)
	Type	---	Repeat avg	---
	Overlap	---%	Fast avg	---

NOTE The field indicated as “---” may be any value or automatically set.

Configure the 8648

1. Set the frequency, press: **FREQUENCY, 155, MHz.**
2. Set the amplitude, press: **AMPLITUDE, 0, dB(m).**
3. Set the FSK deviation, press: **FM, 4.8, kHz.**
4. Turn the RF output on, press: **RF ON/OFF.**
5. Set **FORMAT** to **SERVICE**; rotate the **AMPLITUDE/ENCODER** knob until **FORMAT SERVICE** appears.
6. Set the FSK mode, press ↓ (NEXT) and rotate the **AMPLITUDE/ENCODER** knob until **CALIBRATION FSK 1200/2** appears.
7. Turn the encoder on, press: **INCR SET (START/STOP).**

Measure FSK Deviation

1. Set the 8648 frequencies and FSK modes shown in [Table 8-2](#).
2. Set the 89441A symbol rate and frequency span as shown in the table.
3. Restart the measurement, press: Measure Restart.
4. Read the FSK deviation value at each symbol by using the marker function, press: Marker, 0 (or 1, 2... 9), sym.
5. record the marker value in the second column of the table.
6. Calculate the deviation error for each symbol by subtracting the desired deviation value from each marker value. Record them in the fourth column of the table.
7. Calculate the deviation error average and record it in the table.
8. Repeat this measurement for the rest of the carrier frequencies and FSK modes listed in [Table 8-2](#).
9. Record the test results and compare the results to the limits in the test record.

Table 8-2. FSK Deviation Accuracy Work Table

Symbol	1 Marker Value	2 Desired Deviation	3 = 1 - 2 Deviation Error	Symbol	1 Marker Value	2 Desired Deviation	3 = 1 - 2 Deviation Error
Frequency = 155 MHz, FSK mode = 1200/2 Symbol rate = 1200 sym/sec, Span = 20 kHz				Frequency = 280 MHz, FSK mode = 1200/2 Symbol rate = 1200 sym/sec, Span = 20 kHz			
0	_____ kHz	-4.8 kHz	_____ kHz	0	_____ kHz	-4.8 kHz	_____ kHz
1	_____ kHz	4.8 kHz	_____ kHz	1	_____ kHz	4.8 kHz	_____ kHz
2	_____ kHz	-4.8 kHz	_____ kHz	2	_____ kHz	-4.8 kHz	_____ kHz
3	_____ kHz	4.8 kHz	_____ kHz	3	_____ kHz	4.8 kHz	_____ kHz
4	_____ kHz	-4.8 kHz	_____ kHz	4	_____ kHz	-4.8 kHz	_____ kHz
5	_____ kHz	4.8 kHz	_____ kHz	5	_____ kHz	4.8 kHz	_____ kHz
6	_____ kHz	-4.8 kHz	_____ kHz	6	_____ kHz	-4.8 kHz	_____ kHz
7	_____ kHz	4.8 kHz	_____ kHz	7	_____ kHz	4.8 kHz	_____ kHz
8	_____ kHz	-4.8 kHz	_____ kHz	8	_____ kHz	-4.8 kHz	_____ kHz
9	_____ kHz	4.8 kHz	_____ kHz	9	_____ kHz	4.8 kHz	_____ kHz
Average = Sum (3) ÷ 10			_____ kHz	Average = Sum (3) ÷ 10			_____ kHz
Frequency = 155 MHz, FSK mode = 6400/4 Symbol rate = 3200 sym/sec, Span = 50 kHz				Frequency = 280 MHz, FSK mode = 6400/4 Symbol rate = 3200 sym/sec, Span = 50 kHz			
0	_____ kHz	4.8 kHz	_____ kHz	0	_____ kHz	4.8 kHz	_____ kHz
1	_____ kHz	1.6 kHz	_____ kHz	1	_____ kHz	1.6 kHz	_____ kHz
2	_____ kHz	-4.8 kHz	_____ kHz	2	_____ kHz	-4.8 kHz	_____ kHz
3	_____ kHz	-1.6 kHz	_____ kHz	3	_____ kHz	-1.6 kHz	_____ kHz
4	_____ kHz	4.8 kHz	_____ kHz	4	_____ kHz	4.8 kHz	_____ kHz
5	_____ kHz	1.6 kHz	_____ kHz	5	_____ kHz	1.6 kHz	_____ kHz
6	_____ kHz	-4.8 kHz	_____ kHz	6	_____ kHz	-4.8 kHz	_____ kHz
7	_____ kHz	-1.6 kHz	_____ kHz	7	_____ kHz	-1.6 kHz	_____ kHz
8	_____ kHz	4.8 kHz	_____ kHz	8	_____ kHz	4.8 kHz	_____ kHz
9	_____ kHz	1.6 kHz	_____ kHz	9	_____ kHz	1.6 kHz	_____ kHz
Average = Sum (3) ÷ 10			_____ kHz	Average = Sum (3) ÷ 10			_____ kHz

Table 8-2. FSK Deviation Accuracy Work Table

Symbol	1 Marker Value	2 Desired Deviation	3 = 1 – 2 Deviation Error	Symbol	1 Marker Value	2 Desired Deviation	3 = 1 – 2 Deviation Error
Frequency = 325 MHz, FSK mode = 1200/2 Symbol rate = 1200 sym/sec, Span = 20 kHz				Frequency = 930 MHz, FSK mode = 1200/2 Symbol rate = 1200 sym/sec, Span = 20 kHz			
0	_____ kHz	-4.8 kHz	_____ kHz	0	_____ kHz	-4.8 kHz	_____ kHz
1	_____ kHz	4.8 kHz	_____ kHz	1	_____ kHz	4.8 kHz	_____ kHz
2	_____ kHz	-4.8 kHz	_____ kHz	2	_____ kHz	-4.8 kHz	_____ kHz
3	_____ kHz	4.8 kHz	_____ kHz	3	_____ kHz	4.8 kHz	_____ kHz
4	_____ kHz	-4.8 kHz	_____ kHz	4	_____ kHz	-4.8 kHz	_____ kHz
5	_____ kHz	4.8 kHz	_____ kHz	5	_____ kHz	4.8 kHz	_____ kHz
6	_____ kHz	-4.8 kHz	_____ kHz	6	_____ kHz	-4.8 kHz	_____ kHz
7	_____ kHz	4.8 kHz	_____ kHz	7	_____ kHz	4.8 kHz	_____ kHz
8	_____ kHz	-4.8 kHz	_____ kHz	8	_____ kHz	-4.8 kHz	_____ kHz
9	_____ kHz	4.8 kHz	_____ kHz	9	_____ kHz	4.8 kHz	_____ kHz
Average = Sum (3) ÷ 10			_____ kHz	Average = Sum (3) ÷ 10			_____ kHz
Frequency = 325 MHz, FSK mode = 6400/4 Symbol rate = 3200 sym/sec, Span = 50 kHz				Frequency = 930 MHz, FSK mode = 6400/4 Symbol rate = 3200 sym/sec, Span = 50 kHz			
0	_____ kHz	4.8 kHz	_____ kHz	0	_____ kHz	4.8 kHz	_____ kHz
1	_____ kHz	1.6 kHz	_____ kHz	1	_____ kHz	1.6 kHz	_____ kHz
2	_____ kHz	-4.8 kHz	_____ kHz	2	_____ kHz	-4.8 kHz	_____ kHz
3	_____ kHz	-1.6 kHz	_____ kHz	3	_____ kHz	-1.6 kHz	_____ kHz
4	_____ kHz	4.8 kHz	_____ kHz	4	_____ kHz	4.8 kHz	_____ kHz
5	_____ kHz	1.6 kHz	_____ kHz	5	_____ kHz	1.6 kHz	_____ kHz
6	_____ kHz	-4.8 kHz	_____ kHz	6	_____ kHz	-4.8 kHz	_____ kHz
7	_____ kHz	-1.6 kHz	_____ kHz	7	_____ kHz	-1.6 kHz	_____ kHz
8	_____ kHz	4.8 kHz	_____ kHz	8	_____ kHz	4.8 kHz	_____ kHz
9	_____ kHz	1.6 kHz	_____ kHz	9	_____ kHz	1.6 kHz	_____ kHz
Average = Sum (3) ÷ 10			_____ kHz	Average = Sum (3) ÷ 10			_____ kHz

Test Record

- 8648A Option 1EP: [Table 8-18.](#)

Internal Timebase: Aging Rate Performance Test (Option 1E5 Only)

Description

This procedure checks the accuracy of the internal timebase. The time required for a specific phase change is measured both before and after a specified waiting period. The aging rate is inversely proportional to the absolute value of the difference in the measured times.

The overall accuracy of the internal timebase is a function of:

$TBC \pm AR \pm TE \pm LE$ where:

TBC = timebase calibration

TE = temperature effects

AR = aging rate

LE = line effects

After the timebase is adjusted, the timebase frequency should stay within the aging rate if the following things happen:

- The timebase oven does not cool down.
- The instrument keeps the same orientation with respect to the earth's magnetic field.
- The instrument stays at the same altitude.
- The instrument does not receive any mechanical shock.

If the timebase oven cools (the instrument power switch is set to off), you may have to readjust the timebase frequency after a new warm-up cycle. typically, however, the timebase frequency returns to within $1 \pm \text{Hz}$ of the original frequency.

NOTE The internal timebase can be tested after reconnecting AC power for 10 minutes, but for best accuracy, test again after the instrument has been on for 24 hours.

Frequency changes due either to a change in orientation with respect to the earth's magnetic field, or to a change in altitude, usually go away when the instrument is returned to its original position. A frequency change due to mechanical shock usually appears as a fixed frequency error.

Connect the Test Equipment

Figure 8-22 Internal Timebase: Aging Rate Equipment Setup

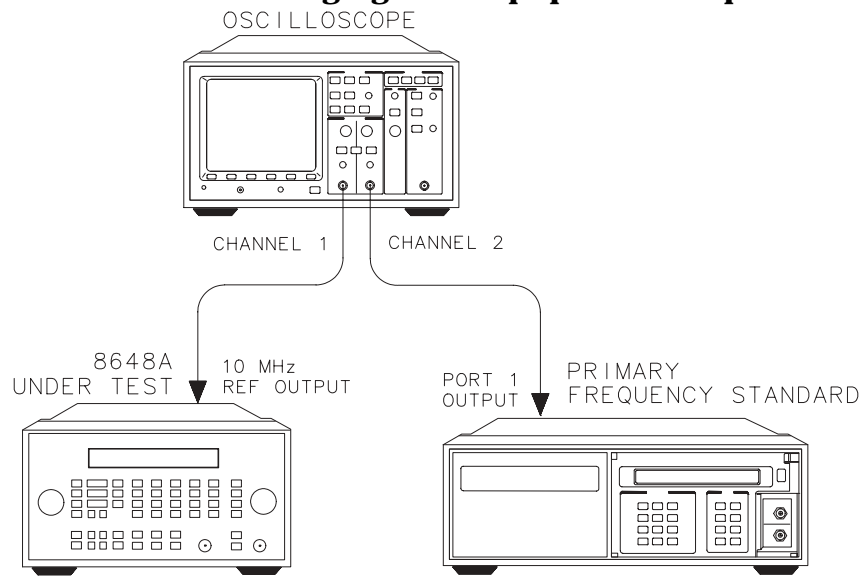

an68abc

1. Connect the equipment as shown in [Figure 8-22](#).
2. Preset all instruments and let them warm up for at least one hour.

NOTE If the oscilloscope does not have a 50Ω input impedance, connect channel 1 through a 50Ω feedthrough.

Configure the Oscilloscope

On the oscilloscope, adjust the external triggering for a display of the 10 MHz REF OUTPUT signal from the synthesizer.

1. Channel 1:
 - Display: On
 - Volts/Division: 500 mV
 - Input Coupling: dc
 - Input Impedance: 50Ω (or use a 50Ω feedthrough)
2. Channel 2:
 - Display: Off
 - Input Coupling: dc
 - Input Impedance: 50Ω (or use a 50Ω feedthrough)
3. Timebase:

Time/Division: 5 ns

4. Trigger:

Trigger Source: CH 2

Trigger Mode: Normal

Trigger level: 0V

If the signal drifts a full cycle (360°) in less than 2 minutes, refer to Chapter 7 and perform the “Internal Reference Oscillator Adjustment.” After the adjustment, restart this performance test.

Measure the Phase Change Time

1. Monitor the time and the display. Note the time required for a 360° phase change:

T1 = _____(s)

2. wait 3 to 24 hours. Note how long you waited:

T2 = _____(h)

3. Repeat step 1. Record the phase change time:

T3 = _____(s)

4. Calculate the aging rate as follows:

$$\text{Aging Rate} = (1 \text{ cycle}/10 \text{ MHz}) (1/T1 - 1/T3) (24 \text{ hours}/T2)$$

Example:

T1 = 351 seconds

T2 = 3 hours

T3 = 349 seconds

$$= (1 \text{ cycle}/10 \text{ MHz}) (1/351\text{s} - 1/349\text{s}) (24\text{h}/3\text{h})$$

$$= 1.306 \times 10^{-11} \text{ per day}$$

5. Record the test results and compare the results to the limits in the test record.

NOTE If the absolute frequency of the standard and of the timebase oscillator are extremely close, you can reduce the measurement time (T1 and T3) by measuring the time required for a phase change of less than 360°. In step 6, change 1 cycle to 0.5 cycle for 180°, or 0.25 cycle for 90°.

Test Record

- 8648A Option 1E5: [Table 8-19.](#)
- 8648B Option 1E5: [Table 8-44.](#)
- 8648C Option 1E5: [Table 8-69.](#)
- 8648D Option 1E5: [Table 8-94.](#)

Power Level Accuracy Performance Test (Automated)

NOTE This performance test is the preferred replacement for the RF Level Accuracy performance test. If this performance test is performed, the RF level Accuracy performance test is not required.

Description

The power level accuracy performance test measures the level of the output power against the specifications

Required Test Equipment

- Power meter
- Power Sensor
- Spectrum Analyzer
- 6 dB Attenuator
- Low Frequency Amplifier
- High Frequency Amplifier

Procedure

Figure 8-23 HF Power Level Accuracy Test Setup (Power Levels > -10 dBm)

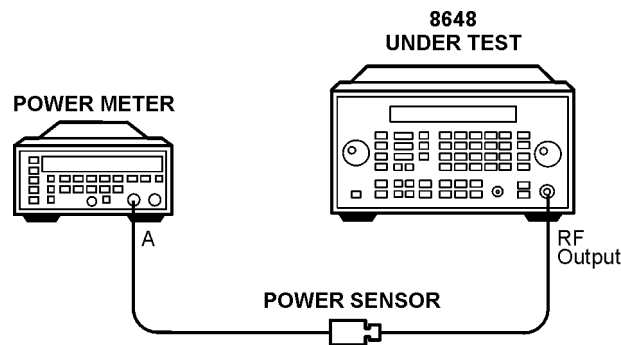

an65a2d

Figure 8-24. HF Power Level Accuracy Test Setup (Power Levels -10 to -70 dBm)

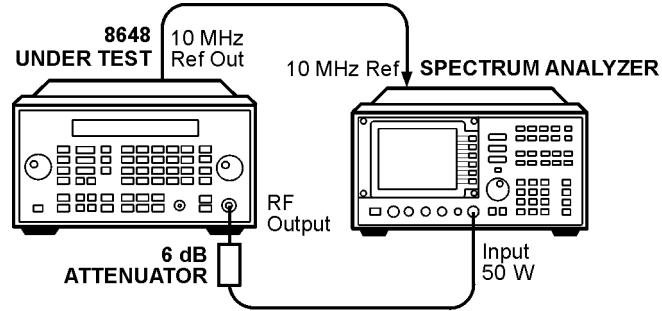

an66a2d

Figure 8-25. HF Power Level Accuracy Test Setup (Power Levels < -70 and ≥ 1300 dBm)

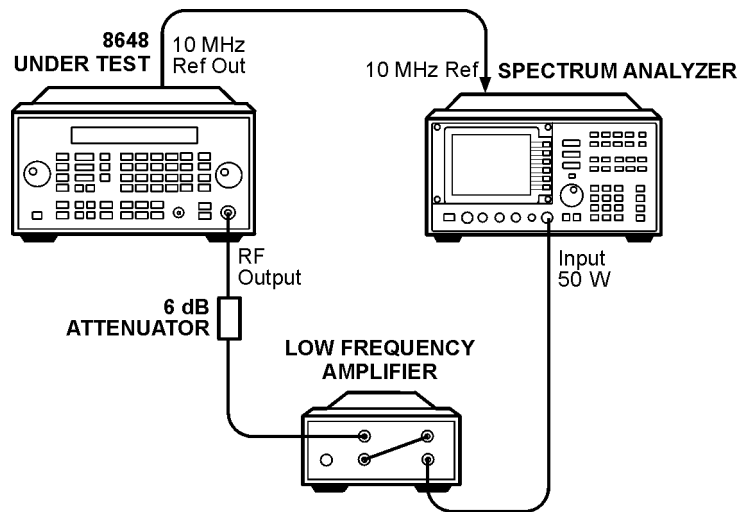

an67a2d

Figure 8-26. HF Power Level Accuracy Test Setup (Power Levels < -70 and > 1300 dBm)

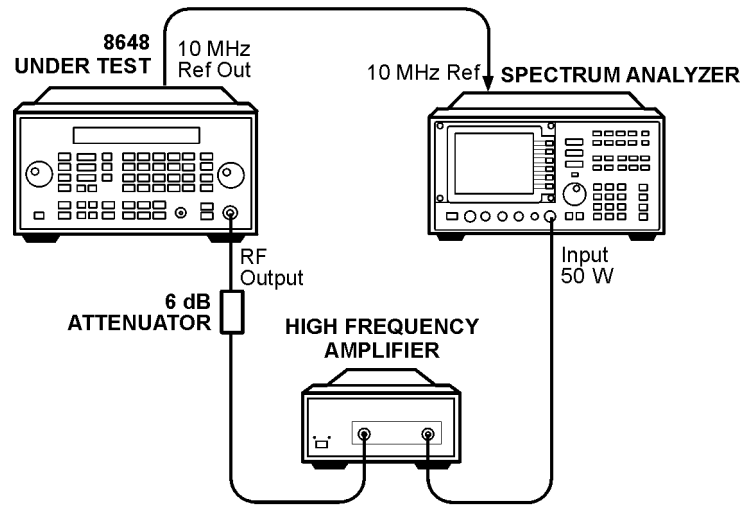

an68a2d

1. Connect the equipment as shown in [Figure 8-23](#).
2. Preset all of the equipment.
3. Follow the instructions as they are displayed on the PC.

8648A Test Record

Table 8-3. 8648A Test Record

Test Facility_____	Report Number_____
_____	Date_____
_____	Customer_____
_____	Tested By_____
Model_____	Ambient Temperature_____xx°C
Serial Number_____	Relative Humidity_____%
Options_____	Line Frequency_____ Hz (nominal)
Firmware Revision_____	
Special Notes:	

Table 8-4. 8648A Test Record

Model _____	Report Number _____		Date _____
Test Equipment Used	Model Number	Trace Number	Cal Due Date
1. Audio Analyzer	_____	_____	_____
2. Measuring Receiver	_____	_____	_____
3. Spectrum Analyzer	_____	_____	_____
4. Synthesized Signal Generator	_____	_____	_____
5. Frequency Counter	_____	_____	_____
6. _____	_____	_____	_____
7. _____	_____	_____	_____
8. _____	_____	_____	_____
9. _____	_____	_____	_____
10. _____	_____	_____	_____
11. _____	_____	_____	_____
12. _____	_____	_____	_____
13. _____	_____	_____	_____
14. _____	_____	_____	_____
15. _____	_____	_____	_____
16. _____	_____	_____	_____
17. _____	_____	_____	_____
18. _____	_____	_____	_____
19. _____	_____	_____	_____
20. _____	_____	_____	_____

Table 8-5. FM Accuracy Performance Test

Frequency (MHz)	Deviation (kHz)	Limits (kHz)			Uncertainty (\pm Hz)
		Lower	Measured	Upper	
0.25	5	4.820		5.180	100
0.25	10	9.670		10.330	200
100	10	9.670		10.330	100
100	5	4.820		5.180	50
250	5	4.820		5.180	50
250	10	9.670		10.330	100
375	10	9.670		10.330	100
375	5	4.820		5.180	50
500	5	4.820		5.180	50
500	10	9.670		10.330	100
756.25	10	9.670		10.330	100
756.25	5	4.820		5.180	50
1000	5	4.820		5.180	50
1000	10	9.670		10.330	100

Table 8-6. FM Accuracy Performance Test Option 1E2

Frequency (MHz)	Deviation (kHz)	Limits (kHz)			Uncertainty (±Hz)
		Lower	Measured	Upper	
0.25	5	4.820		5.180	100
0.25	10	9.670		10.330	200
100	10	9.670		10.330	100
100	5	4.820		5.180	50
250	5	4.820		5.180	50
250	10	9.670		10.330	100
375	10	9.670		10.330	100
375	5	4.820		5.180	50
500	5	4.820		5.180	50
500	10	9.670		10.330	100
756.25	10	9.670		10.330	100
756.25	5	4.820		5.180	50
1000	5	4.820		5.180	50
1000	10	9.670		10.330	100

Table 8-7. FM Distortion Performance Test

Frequency (MHz)	Deviation (kHz)	Limits (%)			Uncertainty (%)
		Lower	Measured	Upper	
10	5	0		1	0.16
10	50	0		1	0.16
10	100	0		1	0.16
100	5	0		1	0.16
100	50	0		1	0.16
100	100	0		1	0.16
400	5	0		1	0.16
400	30	0		1	0.16
400	50	0		1	0.16
756.25	5	0		1	0.16
756.25	50	0		1	0.16
756.25	100	0		1	0.16
1000	5	0		1	0.16
1000	50	0		1	0.16
1000	100	0		1	0.16

Table 8-8. AM Accuracy Performance Test

Amplitude (dBm)	Frequency (MHz)	Depth (%)	Limits (%)			Uncertainty (±%)
			Lower	Measured	Upper	
4	2	10	8		12	0.21
	2	30	27		33	0.6
	2	70	65		75	1.5
	2	90	84		96	1.9
	248	10	8		12	0.11
	248	30	27		33	0.31
	248	70	65		75	0.8
	248	90	84		96	1.0
	400	10	8		12	0.11
	400	30	27		33	0.31
	400	70	65		75	0.8
	400	90	84		96	1.0
	700	10	8		12	0.11
	700	30	27		33	0.31
	700	70	65		75	0.8
	700	90	84		96	1.0
	1000	10	8		12	0.11
	1000	30	27		33	0.31
	1000	70	65		75	0.8
	1000	90	84		96	1.0

Table 8-8. AM Accuracy Performance Test

Amplitude (dBm)	Frequency (MHz)	Depth (%)	Limits (%)			Uncertainty (±%)
			Lower	Measured	Upper	
-6	2	10	8		12	0.21
	2	30	27		33	0.6
	2	70	65		75	1.5
	2	90	84		96	1.9
	248	10	8		12	0.11
	248	30	27		33	0.31
	248	70	65		75	0.8
	248	90	84		96	1.0
	400	10	8		12	0.11
	400	30	27		33	0.31
	400	70	65		75	0.8
	400	90	84		96	1.0
	700	10	8		12	0.11
	700	30	27		33	0.31
	700	70	65		75	0.8
	700	90	84		96	1.0
	1000	10	8		12	0.11
	1000	30	27		33	0.31
	1000	70	65		75	0.8
	1000	90	84		96	1.0

Table 8-9. AM Accuracy Option 1E2 Performance Test

Amplitude (dBm)	Frequency (MHz)	Depth (%)	Limits (%)			Uncertainty (±%)
			Lower	Measured	Upper	
4	2	10	8		12	0.21
	2	30	27		33	0.6
	2	70	65		75	1.5
	2	90	84		96	1.9
	248	10	8		12	0.11
	248	30	27		33	0.31
	248	70	65		75	0.8
	248	90	84		96	1.0
	400	10	8		12	0.11
	400	30	27		33	0.31
	400	70	65		75	0.8
	400	90	84		96	1.0
	700	10	8		12	0.11
	700	30	27		33	0.31
	700	70	65		75	0.8
	700	90	84		96	1.0
	1000	10	8		12	0.11
	1000	30	27		33	0.31
	1000	70	65		75	0.8
	1000	90	84		96	1.0

Table 8-9. AM Accuracy Option 1E2 Performance Test

Amplitude (dBm)	Frequency (MHz)	Depth (%)	Limits (%)			Uncertainty (±%)
			Lower	Measured	Upper	
-6	2	10	8		12	0.21
	2	30	27		33	0.6
	2	70	65		75	1.5
	2	90	84		96	1.9
	248	10	8		12	0.11
	248	30	27		33	0.31
	248	70	65		75	0.8
	248	90	84		96	1.0
	400	10	8		12	0.11
	400	30	27		33	0.31
	400	70	65		75	0.8
	400	90	84		96	1.0
	700	10	8		12	0.11
	700	30	27		33	0.31
	700	70	65		75	0.8
	700	90	84		96	1.0
	1000	10	8		12	0.11
	1000	30	27		33	0.31
	1000	70	65		75	0.8
	1000	90	84		96	1.0

Table 8-10. AM Distortion Performance Test

Amplitude (dBm)	Frequency (MHz)	Depth (%)	Limits (%)			Uncertainty (±%)
			Lower	Measured	Upper	
4	2	30	0		2	0.39
	2	90	0		3	0.70
	248	30	0		2	0.39
	248	90	0		3	0.70
	400	30	0		2	0.39
	400	90	0		3	0.70
	700	30	0		2	0.39
	700	90	0		3	0.70
	1000	30	0		2	0.39
	1000	90	0		3	0.70
-6	2	30	0		2	0.39
	2	90	0		3	0.70
	248	30	0		2	0.39
	248	90	0		3	0.70
	400	30	0		2	0.39
	400	90	0		3	0.70
	700	30	0		2	0.39
	700	90	0		3	0.70
	1000	30	0		2	0.39
	1000	90	0		3	0.70

Table 8-11. Phase Modulation Distortion Performance Test

Frequency (MHz)	Deviation (Rad)	Limits (%)			Uncertainty (%)
		Lower	Measured	Upper	
0.250	5	0		1	0.26
100	5	0		1	0.26
400	5	0		1	0.26
500	5	0		1	0.26
750	5	0		1	0.26
1000	5	0		1	0.26

Table 8-12. Residual FM Performance Test

RF Frequency 8648A (MHz)	LO Frequency 8663A (MHz)	Input Frequency 8902A (MHz)	Limits (Hz)		Uncertainty (\pm Hz)
			Upper	Measured	
10	11.5	700	7		0.45
100	101.5	700	7		0.45
248	249.5	700	7		0.45
251	252.5	700	4		0.35
400	401.5	700	4		0.35
501	502.5	700	7		0.45
750	751.5	700	7		0.45
1000	1001.5	700	7		0.45

Table 8-13. Harmonics Performance Test

8648A Frequency (MHz)	8566B Harmonic Frequency (MHz)	Limits (dBc)		Uncertainty (±dB)
		Upper	Measured	
1	2	-30.0		1.2
2	4	-30.0		1.2
5	10	-30.0		1.2
10	20	-30.0		1.2
20	40	-30.0		1.2
100	200	-30.0		1.2
100	300	-30.0		1.2
300	150	-30.0		1.2
500	1000	-30.0		1.2
500	1500	-30.0		1.2
600	1200	-30.0		1.2
600	1800	-30.0		1.2
700	1400	-30.0		1.2
700	2100	-30.0		1.2
800	1600	-30.0		1.2
800	2400	-30.0		1.2
900	1800	-30.0		1.2
1000	2000	-30.0		1.2

Table 8-14. Spurious Performance Test

Amplitude (dBm)	8648A Frequency (MHz)	Spur (MHz)	Limits (dBc)		Uncertainty (\pm dB)
			Upper	Measured	
4	242	274	-55.0		1.2
	247	259	-55.0		1.2
-6	1	999	-55.0		1.2
	1	1000	-55.0		1.2
	41	1000	-55.0		1.2
	61	1000	-55.0		1.2
	91	1000	-55.0		1.2
	102	286	-55.0		1.2
	137	315	-55.0		1.2
	150	148	-55.0		1.2
	150	149	-55.0		1.2
	150	151	-55.0		1.2
	150	152	-55.0		1.2
	167	7	-55.0		1.2
	172	312	-55.0		1.2
	227	92	-55.0		1.2
	232	304	-55.0		1.2
	241	759	-55.0		1.2
	241	1000	-55.0		1.2
242	274	-55.0		1.2	

Table 8-15. DC FM Frequency Error Performance Test

Frequency (MHz)	Deviation (kHz)	Frequency FM Off (Hz)	Frequency FM On (Hz)	Limits (Hz)			Uncertainty (±Hz)
				Lower	Measured	Upper	
100	1			-100		100	1.0
100	5			-100		100	1.0
100	9.9			-100		100	1.0
500	1			-100		100	1.0
500	5			-100		100	1.0
500	9.9			-100		100	1.0
1000	1			-100		100	1.0
1000	5			-100		100	1.0
1000	9.9			-100		100	1.0

NOTE If the automated Power Level Accuracy performance test is performed, the RF Level Accuracy performance test is not required.

Table 8-16. RF Level Accuracy Performance Test

Frequency (MHz)	Amplitude (dBm)	Limits (dBm)			Uncertainty (\pm dB)
		Lower	Measured	Upper	
3	10	9.0		11.0	0.22
	4	3.0		5.0	0.22
	-5.9	-6.9		-4.9	0.22
	-15.9	-16.9		-14.9	0.23
	-25.9	-26.9		-24.9	0.23
	-35.9	-36.9		-34.9	0.23
	-45.9	-46.9		-44.9	0.23
	-55.9	-56.9		-54.9	0.24
	-65.9	-66.9		-64.9	0.24
	-75.9	-76.9		-74.9	0.25
	-85.9	-86.9		-84.9	0.25
	-95.9	-96.9		-94.9	0.25
	-96.0	-97.0		-95.0	0.25
	-105.9	-106.9		-104.9	0.26
	-106.0	-107.0		-105.0	0.26
	-115.9	-116.9		-114.9	0.27
	-116.0	-117.0		-115.0	0.27
	-125.9	-126.9		-124.9	0.28
-126.0	-127.0		-125.0	0.29	
-127.0	-128.0		-126.0	0.29	

Table 8-16. RF Level Accuracy Performance Test

Frequency (MHz)	Amplitude (dBm)	Limits (dBm)			Uncertainty (±dB)
		Lower	Measured	Upper	
249.9	10	9.0		11.0	0.22
	4	3.0		5.0	0.22
	-5.9	-6.9		-4.9	0.22
	-15.9	-16.9		-14.9	0.23
	-25.9	-26.9		-24.9	0.23
	-35.9	-36.9		-34.9	0.23
	-45.9	-46.9		-44.9	0.23
	-55.9	-56.9		-54.9	0.24
	-65.9	-66.9		-64.9	0.24
	-75.9	-76.9		-74.9	0.25
	-85.9	-86.9		-84.9	0.25
	-95.9	-96.9		-94.9	0.25
	-96.0	-97.0		-95.0	0.25
	-105.9	-106.9		-104.9	0.26
	-106.0	-107.0		-105.0	0.26
	-115.9	-116.9		-114.9	0.27
	-116.0	-117.0		-115.0	0.27
-125.9	-126.9		-124.9	0.28	
-126.0	-127.0		-125.0	0.29	
-127.0	-128.0		-126.0	0.29	

Table 8-16. RF Level Accuracy Performance Test

Frequency (MHz)	Amplitude (dBm)	Limits (dBm)			Uncertainty (\pm dB)
		Lower	Measured	Upper	
400	10	9.0		11.0	0.22
	4	3.0		5.0	0.22
	-5.9	-6.9		-4.9	0.22
	-15.9	-16.9		-14.9	0.23
	-25.9	-26.9		-24.9	0.23
	-35.9	-36.9		-34.9	0.23
	-45.9	-46.9		-44.9	0.23
	-55.9	-56.9		-54.9	0.24
	-65.9	-66.9		-64.9	0.24
	-75.9	-76.9		-74.9	0.25
	-85.9	-86.9		-84.9	0.25
	-95.9	-96.9		-94.9	0.25
	-96.0	-97.0		-95.0	0.25
	-105.9	-106.9		-104.9	0.26
	-106.0	-107.0		-105.0	0.26
	-115.9	-116.9		-114.9	0.27
	-116.0	-117.0		-115.0	0.27
	-125.9	-126.9		-124.9	0.28
-126.0	-127.0		-125.0	0.29	
-127.0	-128.0		-126.0	0.29	

Table 8-16. RF Level Accuracy Performance Test

Frequency (MHz)	Amplitude (dBm)	Limits (dBm)			Uncertainty (±dB)
		Lower	Measured	Upper	
512.5	10	9.0		11.0	0.22
	4	3.0		5.0	0.22
	-5.9	-6.9		-4.9	0.22
	-15.9	-16.9		-14.9	0.23
	-25.9	-26.9		-24.9	0.23
	-35.9	-36.9		-34.9	0.23
	-45.9	-46.9		-44.9	0.23
	-55.9	-56.9		-54.9	0.24
	-65.9	-66.9		-64.9	0.24
	-75.9	-76.9		-74.9	0.25
	-85.9	-86.9		-84.9	0.25
	-95.9	-96.9		-94.9	0.25
	-96.0	-97.0		-95.0	0.25
	-105.9	-106.9		-104.9	0.26
	-106.0	-107.0		-105.0	0.26
	-115.9	-116.9		-114.9	0.27
	-116.0	-117.0		-115.0	0.27
-125.9	-126.9		-124.9	0.28	
-126.0	-127.0		-125.0	0.29	
-127.0	-128.0		-126.0	0.29	

Table 8-16. RF Level Accuracy Performance Test

Frequency (MHz)	Amplitude (dBm)	Limits (dBm)			Uncertainty (\pm dB)
		Lower	Measured	Upper	
999.9	10	9.0		11.0	0.22
	4	3.0		5.0	0.22
	-5.9	-6.9		-4.9	0.22
	-15.9	-16.9		-14.9	0.23
	-25.9	-26.9		-24.9	0.23
	-35.9	-36.9		-34.9	0.23
	-45.9	-46.9		-44.9	0.23
	-55.9	-56.9		-54.9	0.24
	-65.9	-66.9		-64.9	0.24
	-75.9	-76.9		-74.9	0.25
	-85.9	-86.9		-84.9	0.25
	-95.9	-96.9		-94.9	0.25
	-96.0	-97.0		-95.0	0.25
	-105.9	-106.9		-104.9	0.26
	-106.0	-107.0		-105.0	0.26
	-115.9	-116.9		-114.9	0.27
	-116.0	-117.0		-115.0	0.27
	-125.9	-126.9		-124.9	0.28
-126.0	-127.0		-125.0	0.29	
-127.0	-128.0		-126.0	0.29	

Table 8-17. Pager Encoder Timebase Accuracy Performance Test Option 1EP

Frequency (MHz)	Limits (kHz)			Uncertainty (±Hz)
	Lower	Measured	Upper	
1600	1599.992		1600.008	0.0011

Table 8-18. FSK Deviation Accuracy Performance Test Option 1EP

Frequency (MHz)	FSK Mode Rate/Level	Limits (kHz)			Uncertainty (±Hz)
		Lower	Measured	Upper	
155	1200/2	-0.060		+0.060	10
	6400/4	-0.060		+0.060	10
280	1200/2	-0.060		+0.060	10
	6400/4	-0.060		+0.060	10
325	1200/2	-0.060		+0.060	10
	6400/4	-0.060		+0.060	10
930	1200/2	-0.060		+0.060	10
	6400/4	-0.060		+0.060	10

Table 8-19. Internal Timebase: Aging Rate Performance Test Option 1E5

Limits (kHz)			Uncertainty (±Hz)
Lower	Measured	Upper	
		$5 \times 10^{-10}/\text{day}$	$\pm\pm 5.6 \times 10^{-11}$

8648B Test Record

Table 8-20. 8648B Test Record

Test Facility_____	Report Number_____
_____	Date_____
_____	Customer_____
_____	Tested By_____
Model_____	Ambient Temperature_____xx°C
Serial Number_____	Relative Humidity_____%
Options_____	Line Frequency_____ Hz (nominal)
Firmware Revision_____	
Special Notes:	

Table 8-21. 8648B Test Record

Model _____	Report Number _____		Date _____
Test Equipment Used	Model Number	Trace Number	Cal Due Date
1. Audio Analyzer	_____	_____	_____
2. Measuring Receiver	_____	_____	_____
3. Spectrum Analyzer	_____	_____	_____
4. Synthesized Signal Generator	_____	_____	_____
5. Frequency Counter	_____	_____	_____
6. _____	_____	_____	_____
7. _____	_____	_____	_____
8. _____	_____	_____	_____
9. _____	_____	_____	_____
10. _____	_____	_____	_____
11. _____	_____	_____	_____
12. _____	_____	_____	_____
13. _____	_____	_____	_____
14. _____	_____	_____	_____
15. _____	_____	_____	_____
16. _____	_____	_____	_____
17. _____	_____	_____	_____
18. _____	_____	_____	_____
19. _____	_____	_____	_____
20. _____	_____	_____	_____

Table 8-22. FM Accuracy Performance Test - Part 1

Frequency (MHz)	Deviation (kHz)	Limits (kHz)			Uncertainty (\pm Hz)
		Lower	Measured	Upper	
0.25	5	4.820		5.180	100
0.25	10	9.670		10.330	200
100	10	9.670		10.330	100
100	5	4.820		5.180	50
250	5	4.820		5.180	50
250	10	9.670		10.330	100
375	10	9.670		10.330	100
375	5	4.820		5.180	50
500	5	4.820		5.180	50
500	10	9.670		10.330	100
756.25	10	9.670		10.330	100
756.25	5	4.820		5.180	50
1000	5	4.820		5.180	50
1000	10	9.670		10.330	100

Table 8-23. FM Accuracy Performance Test - Part 2

RF Frequency 8648B (MHz)	LO Frequency 8663A (MHz)	Input Frequency 8902A (MHz)	Deviation (kHz)	Limits (kHz)			Uncertainty (\pm Hz)
				Lower	Measured	Upper	
1500	1501.5	700	5	4.790		5.210	50
1500	1501.5	700	10	9.640		10.360	100
2000	2001.5	700	5	4.790		5.210	50
2000	2001.5	700	10	9.640		10.360	100

Table 8-24. FM Accuracy Performance Test Option 1E2 - Part 1

Frequency (MHz)	Deviation (kHz)	Limits (kHz)			Uncertainty (\pm Hz)
		Lower	Measured	Upper	
0.25	5	4.820		5.180	100
0.25	10	9.670		10.330	200
100	10	9.670		10.330	100
100	5	4.820		5.180	50
250	5	4.820		5.180	50
250	10	9.670		10.330	100
375	10	9.670		10.330	100
375	5	4.820		5.180	50
500	5	4.820		5.180	50
500	10	9.670		10.330	100
756.25	10	9.670		10.330	100
756.25	5	4.820		5.180	50
1000	5	4.820		5.180	50
1000	10	9.670		10.330	100

Table 8-25. FM Accuracy Performance Test Option 1E2 - Part 2

RF Frequency 8648B (MHz)	LO Frequency 8663A (MHz)	Input Frequency 8902A (MHz)	Deviation (kHz)	Limits (kHz)			Uncertainty (\pm Hz)
				Lower	Measured	Upper	
1500	1501.5	700	5	4.790		5.210	50
1500	1501.5	700	10	9.640		10.360	100
2000	2001.5	700	5	4.790		5.210	50
2000	2001.5	700	10	9.640		10.360	100

Table 8-26. FM Distortion Performance Test - Part 1

Frequency (MHz)	Deviation (kHz)	Limits (%)			Uncertainty (%)
		Lower	Measured	Upper	
10	5	0		1	0.16
10	50	0		1	0.16
10	100	0		1	0.16
100	5	0		1	0.16
100	50	0		1	0.16
100	100	0		1	0.16
400	5	0		1	0.16
400	30	0		1	0.16
400	50	0		1	0.16
756.25	5	0		1	0.16
756.25	50	0		1	0.16
756.25	100	0		1	0.16
1000	5	0		1	0.16
1000	50	0		1	0.16
1000	100	0		1	0.16

Table 8-27. FM Distortion Performance Test - Part 2

RF Frequency 8648B (MHz)	LO Frequency 8663A (MHz)	Input Frequency 8902A (MHz)	Deviation (kHz)	Limits (%)			Uncertainty (%)
				Lower	Measured	Upper	
1500	1501.5	700	10	0		1	0.16
1500	1501.5	700	50	0		1	0.16
1500	1501.5	700	100	0		1	0.16
2000	2001.5	700	10	0		1	0.16
2000	2001.5	700	50	0		1	0.16
2000	2001.5	700	100	0		1	0.16

Table 8-28. AM Accuracy Performance Test

Amplitude (dBm)	Frequency (MHz)	Depth (%)	Limits (%)			Uncertainty (±%)
			Lower	Measured	Upper	
4	2	10	8		12	0.21
	2	30	27		33	0.6
	2	60	55.5		64.5	1.2
	248	10	8		12	0.11
	248	30	27		33	0.31
	248	60	55.5		64.5	0.61
	400	10	8		12	0.11
	400	30	27		33	0.31
	400	60	55.5		64.5	0.61
	700	10	8		12	0.11
	700	30	27		33	0.31
	700	60	55.5		64.5	0.61
	1000	10	8		12	0.11
	1000	30	27		33	0.31
	1000	60	55.5		64.5	0.61

Table 8-28. AM Accuracy Performance Test

Amplitude (dBm)	Frequency (MHz)	Depth (%)	Limits (%)			Uncertainty (±%)
			Lower	Measured	Upper	
-6	2	10	8		12	0.21
	2	30	27		33	0.6
	2	60	55.5		64.5	1.2
	248	10	8		12	0.11
	248	30	27		33	0.31
	248	60	55.5		64.5	0.61
	400	10	8		12	0.11
	400	30	27		33	0.31
	400	60	55.5		64.5	0.61
	700	10	8		12	0.11
	700	30	27		33	0.31
	700	60	55.5		64.5	0.61
	1000	10	8		12	0.11
	1000	30	27		33	0.31
	1000	60	55.5		64.5	0.61

Table 8-29. AM Accuracy Option 1E2 Performance Test

Amplitude (dBm)	Frequency (MHz)	Depth (%)	Limits (%)			Uncertainty (±%)
			Lower	Measured	Upper	
4	2	10	8		12	0.21
	2	30	27		33	0.6
	2	60	55.5		64.5	1.2
	248	10	8		12	0.11
	248	30	27		33	0.31
	248	60	55.5		64.5	0.61
	400	10	8		12	0.11
	400	30	27		33	0.31
	400	60	55.5		64.5	0.61
	700	10	8		12	0.11
	700	30	27		33	0.31
	700	60	55.5		64.5	0.61
	1000	10	8		12	0.11
	1000	30	27		33	0.31
	1000	60	55.5		64.5	0.61

Table 8-29. AM Accuracy Option 1E2 Performance Test

Amplitude (dBm)	Frequency (MHz)	Depth (%)	Limits (%)			Uncertainty (±%)
			Lower	Measured	Upper	
-6	2	10	8		12	0.21
	2	30	27		33	0.6
	2	60	55.5		64.5	1.2
	248	10	8		12	0.11
	248	30	27		33	0.31
	248	60	55.5		64.5	0.61
	400	10	8		12	0.11
	400	30	27		33	0.31
	400	60	55.5		64.5	0.61
	700	10	8		12	0.11
	700	30	27		33	0.31
	700	60	55.5		64.5	0.61
	1000	10	8		12	0.11
	1000	30	27		33	0.31
	1000	60	55.5		64.5	0.61

Table 8-30. AM Distortion Performance Test

Amplitude (dBm)	Frequency (MHz)	Depth (%)	Limits (%)			Uncertainty (±%)
			Lower	Measured	Upper	
4	2	30	0		2	0.39
	2	70	0		3	0.70
	248	30	0		2	0.39
	248	70	0		3	0.70
	400	30	0		2	0.39
	400	70	0		3	0.70
	700	30	0		2	0.39
	700	70	0		3	0.70
	1000	30	0		2	0.39
	1000	70	0		3	0.70
-6	2	30	0		2	0.39
	2	70	0		3	0.70
	248	30	0		2	0.39
	248	70	0		3	0.70
	400	30	0		2	0.39
	400	70	0		3	0.70
	700	30	0		2	0.39
	700	70	0		3	0.70
	1000	30	0		2	0.39
	1000	70	0		3	0.70

Table 8-31. Phase Modulation Distortion Performance Test - Part 1

Frequency (MHz)	Deviation (Rad)	Limits (%)			Uncertainty (%)
		Lower	Measured	Upper	
0.250	5	0		1	0.26
100	5	0		1	0.26
400	5	0		1	0.26
500	5	0		1	0.26
750	5	0		1	0.26
1000	5	0		1	0.26

Table 8-32. Phase Modulation Distortion Performance Test - Part 2

RF Frequency 8648B (MHz)	LO Frequency 8663A (MHz)	Input Frequency 8902A (MHz)	Deviation (Rad)	Limits (%)			Uncertainty (%)
				Lower	Measured	Upper	
1500	1501.5	700	7	0		1	0.26
2000	2001.5	700	7	0		1	0.26

Table 8-33. Residual FM Performance Test

RF Frequency 8648B (MHz)	LO Frequency 8663A (MHz)	Input Frequency 8902A (MHz)	Limits (Hz)		Uncertainty (\pm Hz)
			Upper	Measured	
10	11.5	700	7		0.45
100	101.5	700	7		0.45
248	249.5	700	7		0.45
251	252.5	700	4		0.35
400	401.5	700	4		0.35
501	501.5	700	7		0.45
750	751.5	700	7		0.45
1000	1001.5	700	7		0.45
1500	1501.5	700	14		0.75

Table 8-34. Harmonics Performance Test

8648B Frequency (MHz)	8566B Harmonic Frequency (MHz)	Limits (dBc)		Uncertainty (±dB)
		Upper	Measured	
1	2	-30.0		1.2
2	4	-30.0		1.2
5	10	-30.0		1.2
10	20	-30.0		1.2
20	40	-30.0		1.2
100	200	-30.0		1.2
100	300	-30.0		1.2
300	150	-30.0		1.2
500	1000	-30.0		1.2
500	1500	-30.0		1.2
600	1200	-30.0		1.2
600	1800	-30.0		1.2
700	1400	-30.0		1.2
700	2100	-30.0		1.2
800	1600	-30.0		1.2
800	2400	-30.0		1.2
900	1800	-30.0		1.2
1000	2000	-30.0		1.2
1100	2200	-30.0		1.2
1200	2400	-30.0		1.2
1500	3000	-30.0		2.0
1990	995	-30.0		1.2
2000	3000	-30.0		2.0

Table 8-35. Spurious Performance Test

Amplitude (dBm)	8648A Frequency (MHz)	Spur (MHz)	Limits (dBc)		Uncertainty (\pm dB)
			Upper	Measured	
4	242	274	-55.0		1.2
	247	259	-55.0		1.2
-6	1	999	-55.0		1.2
	1	1000	-55.0		1.2
	41	1000	-55.0		1.2
	61	1000	-55.0		1.2
	91	1000	-55.0		1.2
	102	286	-55.0		1.2
	137	315	-55.0		1.2
	150	148	-55.0		1.2
	150	149	-55.0		1.2
	150	151	-55.0		1.2
	150	152	-55.0		1.2
	167	7	-55.0		1.2
	172	312	-55.0		1.2
	227	92	-55.0		1.2
	232	304	-55.0		1.2
	241	759	-55.0		1.2
241	1000	-55.0		1.2	
242	274	-55.0		1.2	

Table 8-36. DC FM Frequency Error Performance Test

Frequency (MHz)	Deviation (kHz)	Frequency FM Off (Hz)	Frequency FM On (Hz)	Limits (Hz)			Uncertainty (\pm Hz)
				Lower	Measured	Upper	
100	1			-100		100	1.0
100	5			-100		100	1.0
100	9.9			-100		100	1.0
500	1			-100		100	1.0
500	5			-100		100	1.0
500	9.9			-100		100	1.0
1000	1			-100		100	1.0
1000	5			-100		100	1.0
1000	9.9			-100		100	1.0
1500	2			-200		200	1.0
1500	9.9			-200		200	1.0
1500	19.9			-200		200	1.0
2000	2			-200		200	1.0
2000	9.9			-200		200	1.0
2000	19.9			-200		200	1.0

NOTE If the automated Power Level Accuracy performance test is performed, the RF Level Accuracy performance test is not required.

Table 8-37. RF Level Accuracy Performance Test - Part 1

Frequency (MHz)	Amplitude (dBm)	Limits (dBm)			Uncertainty (\pm dB)
		Lower	Measured	Upper	
3	13	12		14	0.22
	10	9.0		11.0	0.22
	4	3.0		5.0	0.22
	-5.9	-6.9		-4.9	0.22
	-15.9	-16.9		-14.9	0.23
	-25.9	-26.9		-24.9	0.23
	-35.9	-36.9		-34.9	0.23
	-45.9	-46.9		-44.9	0.23
	-55.9	-56.9		-54.9	0.24
	-65.9	-66.9		-64.9	0.24
	-75.9	-76.9		-74.9	0.25
	-85.9	-86.9		-84.9	0.25
	-95.9	-96.9		-94.9	0.25
	-96.0	-97.0		-95.0	0.25
	-105.9	-106.9		-104.9	0.26
	-106.0	-107.0		-105.0	0.26
	-115.9	-116.9		-114.9	0.27
	-116.0	-117.0		-115.0	0.27
	-125.9	-126.9		-124.9	0.28
	-126.0	-127.0		-125.0	0.29
-127.0	-128.0		-126.0	0.29	

Table 8-37. RF Level Accuracy Performance Test - Part 1

Frequency (MHz)	Amplitude (dBm)	Limits (dBm)			Uncertainty (\pm dB)
		Lower	Measured	Upper	
249.9	13	12		14	0.22
	10	9.0		11.0	0.22
	4	3.0		5.0	0.22
	-5.9	-6.9		-4.9	0.22
	-15.9	-16.9		-14.9	0.23
	-25.9	-26.9		-24.9	0.23
	-35.9	-36.9		-34.9	0.23
	-45.9	-46.9		-44.9	0.23
	-55.9	-56.9		-54.9	0.24
	-65.9	-66.9		-64.9	0.24
	-75.9	-76.9		-74.9	0.25
	-85.9	-86.9		-84.9	0.25
	-95.9	-96.9		-94.9	0.25
	-96.0	-97.0		-95.0	0.25
	-105.9	-106.9		-104.9	0.26
	-106.0	-107.0		-105.0	0.26
	-115.9	-116.9		-114.9	0.27
	-116.0	-117.0		-115.0	0.27
-125.9	-126.9		-124.9	0.28	
-126.0	-127.0		-125.0	0.29	
-127.0	-128.0		-126.0	0.29	

Table 8-37. RF Level Accuracy Performance Test - Part 1

Frequency (MHz)	Amplitude (dBm)	Limits (dBm)			Uncertainty (\pm dB)
		Lower	Measured	Upper	
400	13	12		140	0.22
	10	9.0		11.0	0.22
	4	3.0		5.0	0.22
	-5.9	-6.9		-4.9	0.22
	-15.9	-16.9		-14.9	0.23
	-25.9	-26.9		-24.9	0.23
	-35.9	-36.9		-34.9	0.23
	-45.9	-46.9		-44.9	0.23
	-55.9	-56.9		-54.9	0.24
	-65.9	-66.9		-64.9	0.24
	-75.9	-76.9		-74.9	0.25
	-85.9	-86.9		-84.9	0.25
	-95.9	-96.9		-94.9	0.25
	-96.0	-97.0		-95.0	0.25
	-105.9	-106.9		-104.9	0.26
	-106.0	-107.0		-105.0	0.26
	-115.9	-116.9		-114.9	0.27
	-116.0	-117.0		-115.0	0.27
	-125.9	-126.9		-124.9	0.28
	-126.0	-127.0		-125.0	0.29
-127.0	-128.0		-126.0	0.29	

Table 8-37. RF Level Accuracy Performance Test - Part 1

Frequency (MHz)	Amplitude (dBm)	Limits (dBm)			Uncertainty (\pm dB)
		Lower	Measured	Upper	
512.5	13	12		14	0.22
	10	9.0		11.0	0.22
	4	3.0		5.0	0.22
	-5.9	-6.9		-4.9	0.22
	-15.9	-16.9		-14.9	0.23
	-25.9	-26.9		-24.9	0.23
	-35.9	-36.9		-34.9	0.23
	-45.9	-46.9		-44.9	0.23
	-55.9	-56.9		-54.9	0.24
	-65.9	-66.9		-64.9	0.24
	-75.9	-76.9		-74.9	0.25
	-85.9	-86.9		-84.9	0.25
	-95.9	-96.9		-94.9	0.25
	-96.0	-97.0		-95.0	0.25
	-105.9	-106.9		-104.9	0.26
	-106.0	-107.0		-105.0	0.26
	-115.9	-116.9		-114.9	0.27
	-116.0	-117.0		-115.0	0.27
-125.9	-126.9		-124.9	0.28	
-126.0	-127.0		-125.0	0.29	
	-127.0	-128.0		-126.0	0.29

Table 8-37. RF Level Accuracy Performance Test - Part 1

Frequency (MHz)	Amplitude (dBm)	Limits (dBm)			Uncertainty (\pm dB)
		Lower	Measured	Upper	
999.9	13	12		140	0.22
	10	9.0		11.0	0.22
	4	3.0		5.0	0.22
	-5.9	-6.9		-4.9	0.22
	-15.9	-16.9		-14.9	0.23
	-25.9	-26.9		-24.9	0.23
	-35.9	-36.9		-34.9	0.23
	-45.9	-46.9		-44.9	0.23
	-55.9	-56.9		-54.9	0.24
	-65.9	-66.9		-64.9	0.24
	-75.9	-76.9		-74.9	0.25
	-85.9	-86.9		-84.9	0.25
	-95.9	-96.9		-94.9	0.25
	-96.0	-97.0		-95.0	0.25
	-105.9	-106.9		-104.9	0.26
	-106.0	-107.0		-105.0	0.26
	-115.9	-116.9		-114.9	0.27
	-116.0	-117.0		-115.0	0.27
	-125.9	-126.9		-124.9	0.28
	-126.0	-127.0		-125.0	0.29
-127.0	-128.0		-126.0	0.29	

Table 8-37. RF Level Accuracy Performance Test - Part 1

Frequency (MHz)	Amplitude (dBm)	Limits (dBm)			Uncertainty (±dB)
		Lower	Measured	Upper	
1300	13	12		140	0.22
	10	9.0		11.0	0.22
	4	3.0		5.0	0.22
	-5.9	-6.9		-4.9	0.22
	-15.9	-16.9		-14.9	0.23
	-25.9	-26.9		-24.9	0.23
	-35.9	-36.9		-34.9	0.23
	-45.9	-46.9		-44.9	0.23
	-55.9	-56.9		-54.9	0.24
	-65.9	-66.9		-64.9	0.24
	-75.9	-76.9		-74.9	0.25
	-85.9	-86.9		-84.9	0.25
	-95.9	-96.9		-94.9	0.25
	-96.0	-97.0		-95.0	0.25
	-105.9	-106.9		-104.9	0.26
	-106.0	-107.0		-105.0	0.26
	-115.9	-116.9		-114.9	0.27
	-116.0	-117.0		-115.0	0.27
	-125.9	-126.9		-124.9	0.28
-126.0	-127.0		-125.0	0.29	
-127.0	-128.0		-126.0	0.29	

NOTE If the automated Power Level Accuracy performance test is performed, the RF Level Accuracy performance test is not required.

Table 8-38. RF Level Accuracy Performance Test - Part 2

Frequency (MHz)	Amplitude (dBm)	Limits (dBm)			Uncertainty (\pm dB)
		Lower	Measured	Upper	
2000	13	12		14	0.15
	10	9		11	0.15
	4	3		5	0.15
	-5.9	-6.9		-4.9	0.15
	-15.9	-16.9		-14.9	0.12

NOTE If the automated Power Level Accuracy performance test is performed, the RF Level Accuracy performance test is not required.

Table 8-39. RF Level Accuracy Performance Test - Part 3

Frequency (MHz)	Amplitude (dBm)	Limits (dBm)			Uncertainty (\pm dB)
		Lower	Measured	Upper	
3.0	20	18.5		21.5	0.23
249.9	20	18.5		21.5	0.23
400	20	18.5		21.5	0.23
999.9	20	18.5		21.5	0.23
1500	19	17.5		20.5	0.23

NOTE If the automated Power Level Accuracy performance test is performed, the

RF Level Accuracy performance test is not required.

Table 8-40. RF Level Accuracy Performance Test with Option 1EA and 1E6 - Part 3

Frequency (MHz)	Amplitude (dBm)	Limits (dBm)			Uncertainty (\pm dB)
		Lower	Measured	Upper	
3.0	13	11.5		14.5	0.23
249.9	18	16.5		19.5	0.23
400	18	16.5		19.5	0.23
999.9	18	16.5		19.5	0.23
1500	17	15.5		18.5	0.23

NOTE If the automated Power Level Accuracy performance test is performed, the RF Level Accuracy performance test is not required.

Table 8-41. RF Level Accuracy Performance Test - Part 4

Frequency (MHz)	Amplitude (dBm)	Limits (dBm)			Uncertainty (\pm dB)
		Lower	Measured	Upper	
2000	-25.9	-26.9		-24.9	0.16
	-35.9	-36.9		-34.9	0.16
	-45.9	-46.9		-44.9	0.16
	-55.9	-56.9		-54.9	0.16

Table 8-42. Pulse Modulation On/Off Ratio Performance Test Option 1E6

Frequency (MHz)	Limits (dB)		Uncertainty (\pm dB)
	Measured	Upper	
100		80	1.8
500		80	2
1000		80	2
1500		80	2
2000		80	2

Table 8-43. Pulse Modulation Rise Time Performance Test Option 1E6

Frequency (MHz)	Limits (ns)		Uncertainty (±ns)
	Measured	Upper	
1000		10	1

Table 8-44. Internal Timebase: Aging Rate Performance Test Option 1E5

Limits (kHz)			Uncertainty (±Hz)
Lower	Measured	Upper	
		$5 \times 10^{-10}/\text{day}$	$\pm\pm 5.6 \times 10^{-11}$

8648C Test Record

Table 8-45. 8648C Test Record

Test Facility_____	Report Number_____
_____	Date_____
_____	Customer_____
_____	Tested By_____
Model_____	Ambient Temperature_____xx°C
Serial Number_____	Relative Humidity_____%
Options_____	Line Frequency_____ Hz (nominal)
Firmware Revision_____	
Special Notes:	

Table 8-46. 8648C Test Record

Model _____	Report Number _____		Date _____
Test Equipment Used	Model Number	Trace Number	Cal Due Date
1. Audio Analyzer	_____	_____	_____
2. Measuring Receiver	_____	_____	_____
3. Spectrum Analyzer	_____	_____	_____
4. Synthesized Signal Generator	_____	_____	_____
5. Frequency Counter	_____	_____	_____
6. _____	_____	_____	_____
7. _____	_____	_____	_____
8. _____	_____	_____	_____
9. _____	_____	_____	_____
10. _____	_____	_____	_____
11. _____	_____	_____	_____
12. _____	_____	_____	_____
13. _____	_____	_____	_____
14. _____	_____	_____	_____
15. _____	_____	_____	_____
16. _____	_____	_____	_____
17. _____	_____	_____	_____
18. _____	_____	_____	_____
19. _____	_____	_____	_____
20. _____	_____	_____	_____

Table 8-47. FM Accuracy Performance Test - Part 1

Frequency (MHz)	Deviation (kHz)	Limits (kHz)			Uncertainty (\pm Hz)
		Lower	Measured	Upper	
0.25	5	4.820		5.180	100
0.25	10	9.670		10.330	200
100	10	9.670		10.330	100
100	5	4.820		5.180	50
250	5	4.820		5.180	50
250	10	9.670		10.330	100
375	10	9.670		10.330	100
375	5	4.820		5.180	50
500	5	4.820		5.180	50
500	10	9.670		10.330	100
756.25	10	9.670		10.330	100
756.25	5	4.820		5.180	50
1000	5	4.820		5.180	50
1000	10	9.670		10.330	100

Table 8-48. FM Accuracy Performance Test - Part 2

RF Frequency 8648C (MHz)	LO Frequency 8663A (MHz)	Input Frequency 8902A (MHz)	Deviation (kHz)	Limits (kHz)			Uncertainty (\pm Hz)
				Lower	Measured	Upper	
1500	1501.5	700	5	4.790		5.210	50
1500	1501.5	700	10	9.640		10.360	100
2000	2001.5	700	5	4.790		5.210	50
2000	2001.5	700	10	9.640		10.360	100
2500	2501.5	700	5	4.730		5.270	50
2500	2501.5	700	10	9.580		10.420	100
3200	2500	700	5	4.730		5.270	50
3200	2500	700	10	9.580		10.420	100

Table 8-49. FM Accuracy Performance Test Option 1E2 - Part 1

Frequency (MHz)	Deviation (kHz)	Limits (kHz)			Uncertainty (\pm Hz)
		Lower	Measured	Upper	
0.25	5	4.820		5.180	100
0.25	10	9.670		10.330	200
100	10	9.670		10.330	100
100	5	4.820		5.180	50
250	5	4.820		5.180	50
250	10	9.670		10.330	100
375	10	9.670		10.330	100
375	5	4.820		5.180	50
500	5	4.820		5.180	50
500	10	9.670		10.330	100
756.25	10	9.670		10.330	100
756.25	5	4.820		5.180	50
1000	5	4.820		5.180	50
1000	10	9.670		10.330	100

Table 8-50. FM Accuracy Performance Test Option 1E2 - Part 2

RF Frequency 8648C (MHz)	LO Frequency 8663A (MHz)	Input Frequency 8902A (MHz)	Deviation (kHz)	Limits (kHz)			Uncertainty (\pm Hz)
				Lower	Measured	Upper	
1500	1501.5	700	5	4.790		5.210	50
1500	1501.5	700	10	9.640		10.360	100
2000	2001.5	700	5	4.790		5.210	50
2000	2001.5	700	10	9.640		10.360	100
2500	2501.5	700	5	4.730		5.270	50
2500	2501.5	700	10	9.580		10.420	100
3200	2500	700	5	4.730		5.270	50
3200	2500	700	10	9.580		10.420	100

Table 8-51. FM Distortion Performance Test - Part 1

Frequency (MHz)	Deviation (kHz)	Limits (%)			Uncertainty (%)
		Lower	Measured	Upper	
10	5	0		1	0.16
10	50	0		1	0.16
10	100	0		1	0.16
100	5	0		1	0.16
100	50	0		1	0.16
100	100	0		1	0.16
400	5	0		1	0.16
400	30	0		1	0.16
400	50	0		1	0.16
756.25	5	0		1	0.16
756.25	50	0		1	0.16
756.25	100	0		1	0.16
1000	5	0		1	0.16
1000	50	0		1	0.16
1000	100	0		1	0.16

Table 8-52. FM Distortion Performance Test - Part 2

RF Frequency 8648C (MHz)	LO Frequency 8663A (MHz)	Input Frequency 8902A (MHz)	Deviation (kHz)	Limits (%)			Uncertainty (%)
				Lower	Measured	Upper	
1500	1501.5	700	10	0		1	0.16
1500	1501.5	700	50	0		1	0.16
1500	1501.5	700	100	0		1	0.16
2000	2001.5	700	10	0		1	0.16
2000	2001.5	700	50	0		1	0.16
2000	2001.5	700	100	0		1	0.16
3200	2500	700	20	0		1	0.16
3200	2500	700	50	0		1	0.16
3200	2500	700	100	0		1	0.16

Table 8-53. AM Accuracy Performance Test

Amplitude (dBm)	Frequency (MHz)	Depth (%)	Limits (%)			Uncertainty (±%)
			Lower	Measured	Upper	
4	2	10	8		12	0.21
	2	30	27		33	0.6
	2	60	55.5		64.5	1.2
	248	10	8		12	0.11
	248	30	27		33	0.31
	248	60	55.5		64.5	0.61
	400	10	8		12	0.11
	400	30	27		33	0.31
	400	60	55.5		64.5	0.61
	700	10	8		12	0.11
	700	30	27		33	0.31
	700	60	55.5		64.5	0.61
	1000	10	8		12	0.11
	1000	30	27		33	0.31
	1000	60	55.5		64.5	0.61

Table 8-53. AM Accuracy Performance Test

Amplitude (dBm)	Frequency (MHz)	Depth (%)	Limits (%)			Uncertainty (±%)
			Lower	Measured	Upper	
-6	2	10	8		12	0.21
	2	30	27		33	0.6
	2	60	55.5		64.5	1.2
	248	10	8		12	0.11
	248	30	27		33	0.31
	248	60	55.5		64.5	0.61
	400	10	8		12	0.11
	400	30	27		33	0.31
	400	60	55.5		64.5	0.61
	700	10	8		12	0.11
	700	30	27		33	0.31
	700	60	55.5		64.5	0.61
	1000	10	8		12	0.11
	1000	30	27		33	0.31
	1000	60	55.5		64.5	0.61

Table 8-54. AM Accuracy Option 1E2 Performance Test

Amplitude (dBm)	Frequency (MHz)	Depth (%)	Limits (%)			Uncertainty (±%)
			Lower	Measured	Upper	
4	2	10	8		12	0.21
	2	30	27		33	0.6
	2	60	55.5		64.5	1.2
	248	10	8		12	0.11
	248	30	27		33	0.31
	248	60	55.5		64.5	0.61
	400	10	8		12	0.11
	400	30	27		33	0.31
	400	60	55.5		64.5	0.61
	700	10	8		12	0.11
	700	30	27		33	0.31
	700	60	55.5		64.5	0.61
	1000	10	8		12	0.11
	1000	30	27		33	0.31
	1000	60	55.5		64.5	0.61

Table 8-54. AM Accuracy Option 1E2 Performance Test

Amplitude (dBm)	Frequency (MHz)	Depth (%)	Limits (%)			Uncertainty (±%)
			Lower	Measured	Upper	
-6	2	10	8		12	0.21
	2	30	27		33	0.6
	2	60	55.5		64.5	1.2
	248	10	8		12	0.11
	248	30	27		33	0.31
	248	60	55.5		64.5	0.61
	400	10	8		12	0.11
	400	30	27		33	0.31
	400	60	55.5		64.5	0.61
	700	10	8		12	0.11
	700	30	27		33	0.31
	700	60	55.5		64.5	0.61
	1000	10	8		12	0.11
	1000	30	27		33	0.31
	1000	60	55.5		64.5	0.61

Table 8-55. AM Distortion Performance Test

Amplitude (dBm)	Frequency (MHz)	Depth (%)	Limits (%)			Uncertainty (±%)
			Lower	Measured	Upper	
4	2	30	0		2	0.39
	2	70	0		3	0.70
	248	30	0		2	0.39
	248	70	0		3	0.70
	400	30	0		2	0.39
	400	70	0		3	0.70
	1000	30	0		2	0.39
	1000	70	0		3	0.70
-6	2	30	0		2	0.39
	2	70	0		3	0.70
	248	30	0		2	0.39
	248	70	0		3	0.70
	400	30	0		2	0.39
	400	70	0		3	0.70
	1000	30	0		2	0.39
	1000	70	0		3	0.70

Table 8-56. Phase Modulation Distortion Performance Test - Part 1

Frequency (MHz)	Deviation (Rad)	Limits (%)			Uncertainty (%)
		Lower	Measured	Upper	
0.250	5	0		1	0.26
100	5	0		1	0.26
400	5	0		1	0.26
500	5	0		1	0.26
750	5	0		1	0.26
1000	5	0		1	0.26

Table 8-57. Phase Modulation Distortion Performance Test - Part 2

RF Frequency 8648C (MHz)	LO Frequency 8663A (MHz)	Input Frequency 8902A (MHz)	Deviation (Rad)	Limits (%)			Uncertainty (%)
				Lower	Measured	Upper	
1500	1501.5	700	7	0		1	0.26
2000	2001.5	700	7	0		1	0.26
2500	2501.5	700	14	0		1	0.26
3200	2500	700	14	0		1	0.26

Table 8-58. Residual FM Performance Test

RF Frequency 8648C (MHz)	LO Frequency 8663A (MHz)	Input Frequency 8902A (MHz)	Limits (Hz)		Uncertainty (±Hz)
			Upper	Measured	
10	11.5	700	7		0.45
100	101.5	700	7		0.45
248	249.5	700	7		0.45
251	252.5	700	4		0.35
400	401.5	700	4		0.35
501	501.5	700	7		0.45
750	751.5	700	7		0.45
1000	1001.5	700	7		0.45
1500	1501.5	700	14		0.75
2500	2501.5	700	28		1.5

Table 8-59. Harmonics Performance Test

8648C Frequency (MHz)	8566B Harmonic Frequency (MHz)	Limits (dBc)		Uncertainty (±dB)
		Upper	Measured	
1	2	-30.0		1.2
2	4	-30.0		1.2
5	10	-30.0		1.2
10	20	-30.0		1.2
20	40	-30.0		1.2
100	200	-30.0		1.2
100	300	-30.0		1.2
300	150	-30.0		1.2
500	1000	-30.0		1.2
500	1500	-30.0		1.2
600	1200	-30.0		1.2
600	1800	-30.0		1.2
700	1400	-30.0		1.2
700	2100	-30.0		1.2
800	1600	-30.0		1.2
800	2400	-30.0		1.2
900	1800	-30.0		1.2
1000	2000	-30.0		1.2
1100	2200	-30.0		1.2
1200	2400	-30.0		1.2
1500	3000	-30.0		2.0
1990	995	-30.0		1.2
2000	3000	-30.0		2.0
3200	1600	-30.0		1.2

Table 8-60. Spurious Performance Test

Amplitude (dBm)	8648C Frequency (MHz)	Spur (MHz)	Limits (dBc)		Uncertainty (±dB)
			Upper	Measured	
4	242	274	-55.0		1.2
	247	259	-55.0		1.2
-6	1	999	-55.0		1.2
	1	1000	-55.0		1.2
	41	1000	-55.0		1.2
	61	1000	-55.0		1.2
	91	1000	-55.0		1.2
	102	286	-55.0		1.2
	137	315	-55.0		1.2
	150	148	-55.0		1.2
	150	149	-55.0		1.2
	150	151	-55.0		1.2
	150	152	-55.0		1.2
	167	7	-55.0		1.2
	172	312	-55.0		1.2
	227	92	-55.0		1.2
	232	304	-55.0		1.2
	241	759	-55.0		1.2
241	1000	-55.0		1.2	
242	274	-55.0		1.2	

Table 8-61. DC FM Frequency Error Performance Test

Frequency (MHz)	Deviation (kHz)	Frequency FM Off (Hz)	Frequency FM On (Hz)	Limits (Hz)			Uncertainty (\pm Hz)
				Lower	Measured	Upper	
100	1			-100		100	1.0
100	5			-100		100	1.0
100	9.9			-100		100	1.0
500	1			-100		100	1.0
500	5			-100		100	1.0
500	9.9			-100		100	1.0
1000	1			-100		100	1.0
1000	5			-100		100	1.0
1000	9.9			-100		100	1.0
1500	2			-200		200	1.0
1500	9.9			-200		200	1.0
1500	19.9			-200		200	1.0
2000	2			-200		200	1.0
2000	9.9			-200		200	1.0
2000	19.9			-200		200	1.0
2500	4			-400		400	1.0
2500	19.9			-400		400	1.0
2500	39.9			-400		400	1.0
3200	4			-400		400	1.0
3200	19.9			-400		400	1.0
3200	39.9			-400		400	1.0

NOTE If the automated Power Level Accuracy performance test is performed, the RF Level Accuracy performance test is not required.

Table 8-62. RF Level Accuracy Performance Test - Part 1

Frequency (MHz)	Amplitude (dBm)	Limits (dBm)			Uncertainty (\pm dB)
		Lower	Measured	Upper	
3	13	12		14	0.22
	10	9.0		11.0	0.22
	4	3.0		5.0	0.22
	-5.9	-6.9		-4.9	0.22
	-15.9	-16.9		-14.9	0.23
	-25.9	-26.9		-24.9	0.23
	-35.9	-36.9		-34.9	0.23
	-45.9	-46.9		-44.9	0.23
	-55.9	-56.9		-54.9	0.24
	-65.9	-66.9		-64.9	0.24
	-75.9	-76.9		-74.9	0.25
	-85.9	-86.9		-84.9	0.25
	-95.9	-96.9		-94.9	0.25
	-96.0	-97.0		-95.0	0.25
	-105.9	-106.9		-104.9	0.26
	-106.0	-107.0		-105.0	0.26
	-115.9	-116.9		-114.9	0.27
	-116.0	-117.0		-115.0	0.27
	-125.9	-126.9		-124.9	0.28
	-126.0	-127.0		-125.0	0.29
-127.0	-128.0		-126.0	0.29	

Table 8-62. RF Level Accuracy Performance Test - Part 1

Frequency (MHz)	Amplitude (dBm)	Limits (dBm)			Uncertainty (\pm dB)
		Lower	Measured	Upper	
249.9	13	12		14	0.22
	10	9.0		11.0	0.22
	4	3.0		5.0	0.22
	-5.9	-6.9		-4.9	0.22
	-15.9	-16.9		-14.9	0.23
	-25.9	-26.9		-24.9	0.23
	-35.9	-36.9		-34.9	0.23
	-45.9	-46.9		-44.9	0.23
	-55.9	-56.9		-54.9	0.24
	-65.9	-66.9		-64.9	0.24
	-75.9	-76.9		-74.9	0.25
	-85.9	-86.9		-84.9	0.25
	-95.9	-96.9		-94.9	0.25
	-96.0	-97.0		-95.0	0.25
	-105.9	-106.9		-104.9	0.26
	-106.0	-107.0		-105.0	0.26
	-115.9	-116.9		-114.9	0.27
	-116.0	-117.0		-115.0	0.27
	-125.9	-126.9		-124.9	0.28
-126.0	-127.0		-125.0	0.29	
-127.0	-128.0		-126.0	0.29	

Table 8-62. RF Level Accuracy Performance Test - Part 1

Frequency (MHz)	Amplitude (dBm)	Limits (dBm)			Uncertainty (±dB)
		Lower	Measured	Upper	
400	13	12		140	0.22
	10	9.0		11.0	0.22
	4	3.0		5.0	0.22
	-5.9	-6.9		-4.9	0.22
	-15.9	-16.9		-14.9	0.23
	-25.9	-26.9		-24.9	0.23
	-35.9	-36.9		-34.9	0.23
	-45.9	-46.9		-44.9	0.23
	-55.9	-56.9		-54.9	0.24
	-65.9	-66.9		-64.9	0.24
	-75.9	-76.9		-74.9	0.25
	-85.9	-86.9		-84.9	0.25
	-95.9	-96.9		-94.9	0.25
	-96.0	-97.0		-95.0	0.25
	-105.9	-106.9		-104.9	0.26
	-106.0	-107.0		-105.0	0.26
	-115.9	-116.9		-114.9	0.27
	-116.0	-117.0		-115.0	0.27
	-125.9	-126.9		-124.9	0.28
	-126.0	-127.0		-125.0	0.29
-127.0	-128.0		-126.0	0.29	

Table 8-62. RF Level Accuracy Performance Test - Part 1

Frequency (MHz)	Amplitude (dBm)	Limits (dBm)			Uncertainty (\pm dB)
		Lower	Measured	Upper	
512.5	13	12		14	0.22
	10	9.0		11.0	0.22
	4	3.0		5.0	0.22
	-5.9	-6.9		-4.9	0.22
	-15.9	-16.9		-14.9	0.23
	-25.9	-26.9		-24.9	0.23
	-35.9	-36.9		-34.9	0.23
	-45.9	-46.9		-44.9	0.23
	-55.9	-56.9		-54.9	0.24
	-65.9	-66.9		-64.9	0.24
	-75.9	-76.9		-74.9	0.25
	-85.9	-86.9		-84.9	0.25
	-95.9	-96.9		-94.9	0.25
	-96.0	-97.0		-95.0	0.25
	-105.9	-106.9		-104.9	0.26
	-106.0	-107.0		-105.0	0.26
	-115.9	-116.9		-114.9	0.27
	-116.0	-117.0		-115.0	0.27
-125.9	-126.9		-124.9	0.28	
-126.0	-127.0		-125.0	0.29	
	-127.0	-128.0		-126.0	0.29

Table 8-62. RF Level Accuracy Performance Test - Part 1

Frequency (MHz)	Amplitude (dBm)	Limits (dBm)			Uncertainty (\pm dB)
		Lower	Measured	Upper	
999.9	13	12		140	0.22
	10	9.0		11.0	0.22
	4	3.0		5.0	0.22
	-5.9	-6.9		-4.9	0.22
	-15.9	-16.9		-14.9	0.23
	-25.9	-26.9		-24.9	0.23
	-35.9	-36.9		-34.9	0.23
	-45.9	-46.9		-44.9	0.23
	-55.9	-56.9		-54.9	0.24
	-65.9	-66.9		-64.9	0.24
	-75.9	-76.9		-74.9	0.25
	-85.9	-86.9		-84.9	0.25
	-95.9	-96.9		-94.9	0.25
	-96.0	-97.0		-95.0	0.25
	-105.9	-106.9		-104.9	0.26
	-106.0	-107.0		-105.0	0.26
	-115.9	-116.9		-114.9	0.27
	-116.0	-117.0		-115.0	0.27
	-125.9	-126.9		-124.9	0.28
	-126.0	-127.0		-125.0	0.29
-127.0	-128.0		-126.0	0.29	

Table 8-62. RF Level Accuracy Performance Test - Part 1

Frequency (MHz)	Amplitude (dBm)	Limits (dBm)			Uncertainty (±dB)
		Lower	Measured	Upper	
1300	13	12		140	0.22
	10	9.0		11.0	0.22
	4	3.0		5.0	0.22
	-5.9	-6.9		-4.9	0.22
	-15.9	-16.9		-14.9	0.23
	-25.9	-26.9		-24.9	0.23
	-35.9	-36.9		-34.9	0.23
	-45.9	-46.9		-44.9	0.23
	-55.9	-56.9		-54.9	0.24
	-65.9	-66.9		-64.9	0.24
	-75.9	-76.9		-74.9	0.25
	-85.9	-86.9		-84.9	0.25
	-95.9	-96.9		-94.9	0.25
	-96.0	-97.0		-95.0	0.25
	-105.9	-106.9		-104.9	0.26
	-106.0	-107.0		-105.0	0.26
	-115.9	-116.9		-114.9	0.27
	-116.0	-117.0		-115.0	0.27
	-125.9	-126.9		-124.9	0.28
-126.0	-127.0		-125.0	0.29	
-127.0	-128.0		-126.0	0.29	

NOTE If the automated Power Level Accuracy performance test is performed, the RF Level Accuracy performance test is not required.

Table 8-63. RF Level Accuracy Performance Test - Part 2

Frequency (MHz)	Amplitude (dBm)	Limits (dBm)			Uncertainty (\pm dB)
		Lower	Measured	Upper	
2000	13	12		14	0.15
	10	9		11	0.15
	4	3		5	0.15
	-5.9	-6.9		-4.9	0.15
	-15.9	-16.9		-14.9	0.12
2499	13	12		14	0.32
	10	9		11	0.32
	4	3		5	0.32
	-5.9	-6.9		-4	0.32
	-15.9	-16.9		-14.9	0.25
3200	13	11.5		14.5	0.46
	10	8.5		11.5	0.46
	4	2.5		5.5	0.46
	-5.9	-7.4		-4.4	0.46
	-15.9	-17.4		-14.4	0.41

NOTE If the automated Power Level Accuracy performance test is performed, the

RF Level Accuracy performance test is not required.

Table 8-64. RF Level Accuracy Performance Test - Part 3

Frequency (MHz)	Amplitude (dBm)	Limits (dBm)			Uncertainty (\pm dB)
		Lower	Measured	Upper	
3.0	13	11.5		14.5	0.23
249.9	18	16.5		19.5	0.23
400	18	16.5		19.5	0.23
999.9	18	16.5		19.5	0.23
1500	17	15.5		18.5	0.23
2100	15	13.5		16.5	0.40
2500	13	11.5		14.5	0.58
3200	11	9.0		13.0	0.58

NOTE If the automated Power Level Accuracy performance test is performed, the RF Level Accuracy performance test is not required.

Table 8-65. RF Level Accuracy Performance Test with Option 1EA and 1E6 - Part 3

Frequency (MHz)	Amplitude (dBm)	Limits (dBm)			Uncertainty (\pm dB)
		Lower	Measured	Upper	
3.0	13	11.5		14.5	0.23
249.9	18	16.5		19.5	0.23
400	18	16.5		19.5	0.23
999.9	18	16.5		19.5	0.23
1500	17	15.5		18.5	0.23
2100	15	13.5		16.5	0.40
2500	13	11.5		14.5	0.58
3200	11	9.0		13.0	0.58

NOTE If the automated Power Level Accuracy performance test is performed, the RF Level Accuracy performance test is not required.

Table 8-66. RF Level Accuracy Performance Test - Part 4

Frequency (MHz)	Amplitude (dBm)	Limits (dBm)			Uncertainty (\pm dB)
		Lower	Measured	Upper	
2000	-25.9	-26.9		-24.9	0.16
	-35.9	-36.9		-34.9	0.16
	-45.9	-46.9		-44.9	0.16
	-55.9	-56.9		-54.9	0.16
2499	-25.9	-26.9		-24.9	0.16
	-35.9	-36.9		-34.9	0.16
	-45.9	-46.9		-44.9	0.16
	-55.9	-56.9		-54.9	0.16
3200	-25.9	-27.4		-24.4	0.19
	-35.9	-37.4		-34.4	0.19
	-45.9	-47.4		-44.4	0.19
	-55.9	-57.4		-54.4	0.19

Table 8-67. Pulse Modulation On/Off Ratio Performance Test Option 1E6

Frequency (MHz)	Limits (dB)		Uncertainty (±dB)
	Measured	Upper	
100		80	1.8
500		80	2
1000		80	2
1500		80	2
2000		80	2
2300		70	1.8
2500		70	2
2700		70	2
3000		70	2
3200		70	2

Table 8-68. Pulse Modulation Rise Time Performance Test Option 1E6

Frequency (MHz)	Limits (ns)		Uncertainty (±ns)
	Measured	Upper	
1000		10	1

Table 8-69. Internal Timebase: Aging Rate Performance Test Option 1E5

Limits (kHz)			Uncertainty (±Hz)
Lower	Measured	Upper	
		$5 \times 10^{-10}/\text{day}$	$\pm\pm 5.6 \times 10^{-11}$

8648D Test Record

Table 8-70. 8648D Test Record

Test Facility_____	Report Number_____
_____	Date_____
_____	Customer_____
_____	Tested By_____
Model_____	Ambient Temperature_____xx°C
Serial Number_____	Relative Humidity_____%
Options_____	Line Frequency_____ Hz (nominal)
Firmware Revision_____	
Special Notes:	

Table 8-71. 8648D Test Record

Model _____	Report Number _____		Date _____
Test Equipment Used	Model Number	Trace Number	Cal Due Date
1. Audio Analyzer	_____	_____	_____
2. Measuring Receiver	_____	_____	_____
3. Spectrum Analyzer	_____	_____	_____
4. Synthesized Signal Generator	_____	_____	_____
5. Frequency Counter	_____	_____	_____
6. _____	_____	_____	_____
7. _____	_____	_____	_____
8. _____	_____	_____	_____
9. _____	_____	_____	_____
10. _____	_____	_____	_____
11. _____	_____	_____	_____
12. _____	_____	_____	_____
13. _____	_____	_____	_____
14. _____	_____	_____	_____
15. _____	_____	_____	_____
16. _____	_____	_____	_____
17. _____	_____	_____	_____
18. _____	_____	_____	_____
19. _____	_____	_____	_____
20. _____	_____	_____	_____

Table 8-72. FM Accuracy Performance Test - Part 1

Frequency (MHz)	Deviation (kHz)	Limits (kHz)			Uncertainty (\pm Hz)
		Lower	Measured	Upper	
0.25	5	4.820		5.180	100
0.25	10	9.670		10.330	200
100	10	9.670		10.330	100
100	5	4.820		5.180	50
250	5	4.820		5.180	50
250	10	9.670		10.330	100
375	10	9.670		10.330	100
375	5	4.820		5.180	50
500	5	4.820		5.180	50
500	10	9.670		10.330	100
756.25	10	9.670		10.330	100
756.25	5	4.820		5.180	50
1000	5	4.820		5.180	50
1000	10	9.670		10.330	100

Table 8-73. FM Accuracy Performance Test - Part 2

RF Frequency 8648D (MHz)	LO Frequency 8663A (MHz)	Input Frequency 8902A (MHz)	Deviation (kHz)	Limits (kHz)			Uncertainty (\pm Hz)
				Lower	Measured	Upper	
1500	1501.5	700	5	4.790		5.210	50
1500	1501.5	700	10	9.640		10.360	100
2000	2001.5	700	5	4.790		5.210	50
2000	2001.5	700	10	9.640		10.360	100
2500	2501.5	700	5	4.730		5.270	50
2500	2501.5	700	10	9.580		10.420	100
3200	2500	700	5	4.730		5.270	50
3200	2500	700	10	9.580		10.420	100
3800	2500	700	5	4.730		5.270	50
3800	2500	700	10	9.580		10.420	100

Table 8-74. FM Accuracy Performance Test Option 1E2 - Part 1

Frequency (MHz)	Deviation (kHz)	Limits (kHz)			Uncertainty (\pm Hz)
		Lower	Measured	Upper	
0.25	5	4.820		5.180	100
0.25	10	9.670		10.330	200
100	10	9.670		10.330	100
100	5	4.820		5.180	50
250	5	4.820		5.180	50
250	10	9.670		10.330	100
375	10	9.670		10.330	100
375	5	4.820		5.180	50
500	5	4.820		5.180	50
500	10	9.670		10.330	100
756.25	10	9.670		10.330	100
756.25	5	4.820		5.180	50
1000	5	4.820		5.180	50
1000	10	9.670		10.330	100

Table 8-75. FM Accuracy Performance Test Option 1E2 - Part 2

RF Frequency 8648D (MHz)	LO Frequency 8663A (MHz)	Input Frequency 8902A (MHz)	Deviation (kHz)	Limits (kHz)			Uncertainty (\pm Hz)
				Lower	Measured	Upper	
1500	1501.5	700	5	4.790		5.210	50
1500	1501.5	700	10	9.640		10.360	100
2000	2001.5	700	5	4.790		5.210	50
2000	2001.5	700	10	9.640		10.360	100
2500	2501.5	700	5	4.730		5.270	50
2500	2501.5	700	10	9.580		10.420	100
3200	2500	700	5	4.730		5.270	50
3200	2500	700	10	9.580		10.420	100
3800	2500	1300	5	4.730		5.270	50
3800	2500	1300	10	9.580		10.420	100

Table 8-76. FM Distortion Performance Test - Part 1

Frequency (MHz)	Deviation (kHz)	Limits (%)			Uncertainty (%)
		Lower	Measured	Upper	
10	5	0		1	0.16
10	50	0		1	0.16
10	100	0		1	0.16
100	5	0		1	0.16
100	50	0		1	0.16
100	100	0		1	0.16
400	5	0		1	0.16
400	30	0		1	0.16
400	50	0		1	0.16
756.25	5	0		1	0.16
756.25	50	0		1	0.16
756.25	100	0		1	0.16
1000	5	0		1	0.16
1000	50	0		1	0.16
1000	100	0		1	0.16

Table 8-77. FM Distortion Performance Test - Part 2

RF Frequency 8648D (MHz)	LO Frequency 8663A (MHz)	Input Frequency 8902A (MHz)	Deviation (kHz)	Limits (%)			Uncertainty (%)
				Lower	Measured	Upper	
1500	1501.5	700	10	0		1	0.16
1500	1501.5	700	50	0		1	0.16
1500	1501.5	700	100	0		1	0.16
2000	2001.5	700	10	0		1	0.16
2000	2001.5	700	50	0		1	0.16
2000	2001.5	700	100	0		1	0.16
3200	2500	700	20	0		1	0.16
3200	2500	700	50	0		1	0.16
3200	2500	700	100	0		1	0.16
3800	2500	1300	20	0		1	0.16
3800	2500	1300	50	0		1	0.16
3800	2500	1300	100	0		1	0.16

Table 8-78. AM Accuracy Performance Test

Amplitude (dBm)	Frequency (MHz)	Depth (%)	Limits (%)			Uncertainty (±%)
			Lower	Measured	Upper	
4	2	10	8		12	0.21
	2	30	27		33	0.6
	2	60	55.5		64.5	1.2
	248	10	8		12	0.11
	248	30	27		33	0.31
	248	60	55.5		64.5	0.61
	400	10	8		12	0.11
	400	30	27		33	0.31
	400	60	55.5		64.5	0.61
	700	10	8		12	0.11
	700	30	27		33	0.31
	700	60	55.5		64.5	0.61
	1000	10	8		12	0.11
	1000	30	27		33	0.31
	1000	60	55.5		64.5	0.61

Table 8-78. AM Accuracy Performance Test

Amplitude (dBm)	Frequency (MHz)	Depth (%)	Limits (%)			Uncertainty (±%)
			Lower	Measured	Upper	
-6	2	10	8		12	0.21
	2	30	27		33	0.6
	2	60	55.5		64.5	1.2
	248	10	8		12	0.11
	248	30	27		33	0.31
	248	60	55.5		64.5	0.61
	400	10	8		12	0.11
	400	30	27		33	0.31
	400	60	55.5		64.5	0.61
	700	10	8		12	0.11
	700	30	27		33	0.31
	700	60	55.5		64.5	0.61
	1000	10	8		12	0.11
	1000	30	27		33	0.31
	1000	60	55.5		64.5	0.61

Table 8-79. AM Accuracy Option 1E2 Performance Test

Amplitude (dBm)	Frequency (MHz)	Depth (%)	Limits (%)			Uncertainty (±%)
			Lower	Measured	Upper	
4	2	10	8		12	0.21
	2	30	27		33	0.6
	2	60	55.5		64.5	1.2
	248	10	8		12	0.11
	248	30	27		33	0.31
	248	60	55.5		64.5	0.61
	400	10	8		12	0.11
	400	30	27		33	0.31
	400	60	55.5		64.5	0.61
	700	10	8		12	0.11
	700	30	27		33	0.31
	700	60	55.5		64.5	0.61
	1000	10	8		12	0.11
	1000	30	27		33	0.31
	1000	60	55.5		64.5	0.61

Table 8-79. AM Accuracy Option 1E2 Performance Test

Amplitude (dBm)	Frequency (MHz)	Depth (%)	Limits (%)			Uncertainty (±%)
			Lower	Measured	Upper	
-6	2	10	8		12	0.21
	2	30	27		33	0.6
	2	60	55.5		64.5	1.2
	248	10	8		12	0.11
	248	30	27		33	0.31
	248	60	55.5		64.5	0.61
	400	10	8		12	0.11
	400	30	27		33	0.31
	400	60	55.5		64.5	0.61
	700	10	8		12	0.11
	700	30	27		33	0.31
	700	60	55.5		64.5	0.61
	1000	10	8		12	0.11
	1000	30	27		33	0.31
	1000	60	55.5		64.5	0.61

Table 8-80. AM Distortion Performance Test

Amplitude (dBm)	Frequency (MHz)	Depth (%)	Limits (%)			Uncertainty (±%)
			Lower	Measured	Upper	
4	2	30	0		2	0.39
	2	70	0		3	0.70
	248	30	0		2	0.39
	248	70	0		3	0.70
	400	30	0		2	0.39
	400	70	0		3	0.70
	1000	30	0		2	0.39
	1000	70	0		3	0.70
-6	2	30	0		2	0.39
	2	70	0		3	0.70
	248	30	0		2	0.39
	248	70	0		3	0.70
	400	30	0		2	0.39
	400	70	0		3	0.70
	1000	30	0		2	0.39
	1000	70	0		3	0.70

Table 8-81. Phase Modulation Distortion Performance Test - Part 1

Frequency (MHz)	Deviation (Rad)	Limits (%)			Uncertainty (%)
		Lower	Measured	Upper	
0.250	5	0		1	0.26
100	5	0		1	0.26
400	5	0		1	0.26
500	5	0		1	0.26
750	5	0		1	0.26
1000	5	0		1	0.26

Table 8-82. Phase Modulation Distortion Performance Test - Part 2

RF Frequency 8648D (MHz)	LO Frequency 8663A (MHz)	Input Frequency 8902A (MHz)	Deviation (Rad)	Limits (%)			Uncertainty (%)
				Lower	Measured	Upper	
1500	1501.5	1.5	7	0		1	0.26
2000	2001.5	1.5	7	0		1	0.26
2500	2501.5	1.5	14	0		1	0.26
3200	2500	700	14	0		1	0.26
3800	2500	1300	14	0		1	0.26

Table 8-83. Residual FM Performance Test

RF Frequency 8648D (MHz)	LO Frequency 8663A (MHz)	Input Frequency 8902A (MHz)	Limits (Hz)		Uncertainty (±Hz)
			Upper	Measured	
10	11.5	700	7		0.45
100	101.5	700	7		0.45
248	249.5	700	7		0.45
251	252.5	700	4		0.35
400	401.5	700	4		0.35
501	502.5	700	7		0.45
750	751.5	700	7		0.45
1000	1001.5	700	7		0.45
1500	1501.5	700	14		0.75
2500	2501.5	700	28		1.5
2750	2500	250	28		1.5
3000	2500	500	28		1.8
3200	2500	700	28		2.0
3450	2500	950	28		2.0
3700	2500	1200	28		2.5

Table 8-84. Harmonics Performance Test

8648D Frequency (MHz)	8566B Harmonic Frequency (MHz)	Limits (dBc)		Uncertainty (±dB)
		Upper	Measured	
1	2	-30.0		1.2
2	4	-30.0		1.2
5	10	-30.0		1.2
10	20	-30.0		1.2
20	40	-30.0		1.2
100	200	-30.0		1.2
100	300	-30.0		1.2
300	150	-30.0		1.2
500	1000	-30.0		1.2
500	1500	-30.0		1.2
600	1200	-30.0		1.2
600	1800	-30.0		1.2
700	1400	-30.0		1.2
700	2100	-30.0		1.2
800	1600	-30.0		1.2
800	2400	-30.0		1.2
900	1800	-30.0		1.2
1000	2000	-30.0		1.2
1100	2200	-30.0		1.2
1200	2400	-30.0		1.2
1500	3000	-30.0		2.0
1990	995	-30.0		1.2
2000	3000	-30.0		2.0
3200	1600	-30.0		1.2
3400	1700	-30.0		1.2
3550	1800	-30.0		1.2
4000	2000	-30.0		1.2

Table 8-85. Spurious Performance Test

Amplitude (dBm)	8648C Frequency (MHz)	Spur (MHz)	Limits (dBc)		Uncertainty (\pm dB)
			Upper	Measured	
4	242	274	-55.0		1.2
	247	259	-55.0		1.2
-6	1	999	-55.0		1.2
	1	1000	-55.0		1.2
	41	1000	-55.0		1.2
	61	1000	-55.0		1.2
	91	1000	-55.0		1.2
	102	286	-55.0		1.2
	137	315	-55.0		1.2
	150	148	-55.0		1.2
	150	149	-55.0		1.2
	150	151	-55.0		1.2
	150	152	-55.0		1.2
	167	7	-55.0		1.2
	172	312	-55.0		1.2
	227	92	-55.0		1.2
	232	304	-55.0		1.2
	241	759	-55.0		1.2
	241	1000	-55.0		1.2
242	274	-55.0		1.2	

Table 8-86. DC FM Frequency Error Performance Test

Frequency (MHz)	Deviation (kHz)	Frequency FM Off (Hz)	Frequency FM On (Hz)	Limits (Hz)			Uncertainty (\pm Hz)
				Lower	Measured	Upper	
100	1			-100		100	1.0
100	5			-100		100	1.0
100	9.9			-100		100	1.0
500	1			-100		100	1.0
500	5			-100		100	1.0
500	9.9			-100		100	1.0
1000	1			-100		100	1.0
1000	5			-100		100	1.0
1000	9.9			-100		100	1.0
1500	2			-200		200	1.0
1500	9.9			-200		200	1.0
1500	19.9			-200		200	1.0
2000	2			-200		200	1.0
2000	9.9			-200		200	1.0
2000	19.9			-200		200	1.0
2500	4			-400		400	1.0
2500	19.9			-400		400	1.0
2500	39.9			-400		400	1.0
3200	4			-400		400	1.0
3200	19.9			-400		400	1.0
3200	39.9			-400		400	1.0
4000	4			-400		400	1.0
4000	19.9			-400		400	1.0
4000	39.9			-400		400	1.0

NOTE If the automated Power Level Accuracy performance test is performed, the RF Level Accuracy performance test is not required.

Table 8-87. RF Level Accuracy Performance Test - Part 1

Frequency (MHz)	Amplitude (dBm)	Limits (dBm)			Uncertainty (\pm dB)
		Lower	Measured	Upper	
3	13	12		14	0.22
	10	9.0		11.0	0.22
	4	3.0		5.0	0.22
	-5.9	-6.9		-4.9	0.22
	-15.9	-16.9		-14.9	0.23
	-25.9	-26.9		-24.9	0.23
	-35.9	-36.9		-34.9	0.23
	-45.9	-46.9		-44.9	0.23
	-55.9	-56.9		-54.9	0.24
	-65.9	-66.9		-64.9	0.24
	-75.9	-76.9		-74.9	0.25
	-85.9	-86.9		-84.9	0.25
	-95.9	-96.9		-94.9	0.25
	-96.0	-97.0		-95.0	0.25
	-105.9	-106.9		-104.9	0.26
	-106.0	-107.0		-105.0	0.26
	-115.9	-116.9		-114.9	0.27
	-116.0	-117.0		-115.0	0.27
	-125.9	-126.9		-124.9	0.28
	-126.0	-127.0		-125.0	0.29
-127.0	-128.0		-126.0	0.29	

Table 8-87. RF Level Accuracy Performance Test - Part 1

Frequency (MHz)	Amplitude (dBm)	Limits (dBm)			Uncertainty (\pm dB)
		Lower	Measured	Upper	
249.9	13	12		14	0.22
	10	9.0		11.0	0.22
	4	3.0		5.0	0.22
	-5.9	-6.9		-4.9	0.22
	-15.9	-16.9		-14.9	0.23
	-25.9	-26.9		-24.9	0.23
	-35.9	-36.9		-34.9	0.23
	-45.9	-46.9		-44.9	0.23
	-55.9	-56.9		-54.9	0.24
	-65.9	-66.9		-64.9	0.24
	-75.9	-76.9		-74.9	0.25
	-85.9	-86.9		-84.9	0.25
	-95.9	-96.9		-94.9	0.25
	-96.0	-97.0		-95.0	0.25
	-105.9	-106.9		-104.9	0.26
	-106.0	-107.0		-105.0	0.26
	-115.9	-116.9		-114.9	0.27
	-116.0	-117.0		-115.0	0.27
-125.9	-126.9		-124.9	0.28	
-126.0	-127.0		-125.0	0.29	
-127.0	-128.0		-126.0	0.29	

Table 8-87. RF Level Accuracy Performance Test - Part 1

Frequency (MHz)	Amplitude (dBm)	Limits (dBm)			Uncertainty (\pm dB)
		Lower	Measured	Upper	
400	13	12		140	0.22
	10	9.0		11.0	0.22
	4	3.0		5.0	0.22
	-5.9	-6.9		-4.9	0.22
	-15.9	-16.9		-14.9	0.23
	-25.9	-26.9		-24.9	0.23
	-35.9	-36.9		-34.9	0.23
	-45.9	-46.9		-44.9	0.23
	-55.9	-56.9		-54.9	0.24
	-65.9	-66.9		-64.9	0.24
	-75.9	-76.9		-74.9	0.25
	-85.9	-86.9		-84.9	0.25
	-95.9	-96.9		-94.9	0.25
	-96.0	-97.0		-95.0	0.25
	-105.9	-106.9		-104.9	0.26
	-106.0	-107.0		-105.0	0.26
	-115.9	-116.9		-114.9	0.27
	-116.0	-117.0		-115.0	0.27
	-125.9	-126.9		-124.9	0.28
	-126.0	-127.0		-125.0	0.29
-127.0	-128.0		-126.0	0.29	

Table 8-87. RF Level Accuracy Performance Test - Part 1

Frequency (MHz)	Amplitude (dBm)	Limits (dBm)			Uncertainty (\pm dB)
		Lower	Measured	Upper	
512.5	13	12		14	0.22
	10	9.0		11.0	0.22
	4	3.0		5.0	0.22
	-5.9	-6.9		-4.9	0.22
	-15.9	-16.9		-14.9	0.23
	-25.9	-26.9		-24.9	0.23
	-35.9	-36.9		-34.9	0.23
	-45.9	-46.9		-44.9	0.23
	-55.9	-56.9		-54.9	0.24
	-65.9	-66.9		-64.9	0.24
	-75.9	-76.9		-74.9	0.25
	-85.9	-86.9		-84.9	0.25
	-95.9	-96.9		-94.9	0.25
	-96.0	-97.0		-95.0	0.25
	-105.9	-106.9		-104.9	0.26
	-106.0	-107.0		-105.0	0.26
	-115.9	-116.9		-114.9	0.27
	-116.0	-117.0		-115.0	0.27
-125.9	-126.9		-124.9	0.28	
-126.0	-127.0		-125.0	0.29	
	-127.0	-128.0		-126.0	0.29

Table 8-87. RF Level Accuracy Performance Test - Part 1

Frequency (MHz)	Amplitude (dBm)	Limits (dBm)			Uncertainty (\pm dB)
		Lower	Measured	Upper	
999.9	13	12		140	0.22
	10	9.0		11.0	0.22
	4	3.0		5.0	0.22
	-5.9	-6.9		-4.9	0.22
	-15.9	-16.9		-14.9	0.23
	-25.9	-26.9		-24.9	0.23
	-35.9	-36.9		-34.9	0.23
	-45.9	-46.9		-44.9	0.23
	-55.9	-56.9		-54.9	0.24
	-65.9	-66.9		-64.9	0.24
	-75.9	-76.9		-74.9	0.25
	-85.9	-86.9		-84.9	0.25
	-95.9	-96.9		-94.9	0.25
	-96.0	-97.0		-95.0	0.25
	-105.9	-106.9		-104.9	0.26
	-106.0	-107.0		-105.0	0.26
	-115.9	-116.9		-114.9	0.27
	-116.0	-117.0		-115.0	0.27
	-125.9	-126.9		-124.9	0.28
	-126.0	-127.0		-125.0	0.29
-127.0	-128.0		-126.0	0.29	

Table 8-87. RF Level Accuracy Performance Test - Part 1

Frequency (MHz)	Amplitude (dBm)	Limits (dBm)			Uncertainty (±dB)
		Lower	Measured	Upper	
1300	13	12		140	0.22
	10	9.0		11.0	0.22
	4	3.0		5.0	0.22
	-5.9	-6.9		-4.9	0.22
	-15.9	-16.9		-14.9	0.23
	-25.9	-26.9		-24.9	0.23
	-35.9	-36.9		-34.9	0.23
	-45.9	-46.9		-44.9	0.23
	-55.9	-56.9		-54.9	0.24
	-65.9	-66.9		-64.9	0.24
	-75.9	-76.9		-74.9	0.25
	-85.9	-86.9		-84.9	0.25
	-95.9	-96.9		-94.9	0.25
	-96.0	-97.0		-95.0	0.25
	-105.9	-106.9		-104.9	0.26
	-106.0	-107.0		-105.0	0.26
	-115.9	-116.9		-114.9	0.27
	-116.0	-117.0		-115.0	0.27
-125.9	-126.9		-124.9	0.28	
-126.0	-127.0		-125.0	0.29	
-127.0	-128.0		-126.0	0.29	

NOTE If the automated Power Level Accuracy performance test is performed, the RF Level Accuracy performance test is not required.

Table 8-88. RF Level Accuracy Performance Test - Part 2

Frequency (MHz)	Amplitude (dBm)	Limits (dBm)			Uncertainty (\pm dB)
		Lower	Measured	Upper	
2000	13	12		14	0.15
	10	9		11	0.15
	4	3		5	0.15
	-5.9	-6.9		-4.9	0.15
	-15.9	-16.9		-14.9	0.12
2499	13	12		14	0.32
	10	9		11	0.32
	4	3		5	0.32
	-5.9	-6.9		-4	0.32
	-15.9	-16.9		-14.9	0.25
3200	13	11.5		14.5	0.46
	10	8.5		11.5	0.46
	4	2.5		5.5	0.46
	-5.9	-7.4		-4.4	0.46
	-15.9	-17.4		-14.4	0.41
4000	13	11.0		15.0	0.46
	10	8.0		12	0.53
	4	2.0		6.0	0.53
	-5.9	-7.9		-3.9	0.53
	-15.9	-17.9		-13.9	0.48

NOTE If the automated Power Level Accuracy performance test is performed, the RF Level Accuracy performance test is not required.

Table 8-89. RF Level Accuracy Performance Test - Part 3

Frequency (MHz)	Amplitude (dBm)	Limits (dBm)			Uncertainty (\pm dB)
		Lower	Measured	Upper	
3.0	20	18.5		21.5	0.23
249.9	20	18.5		21.5	0.23
400	20	18.5		21.5	0.23
999.9	20	18.5		21.5	0.23
1500	19	17.5		20.5	0.23
2100	17	15.5		18.5	0.40
2500	15	13.5		16.5	0.58
3200	13	11.5		14.5	0.58
4000	13	11.0		15.0	0.58

NOTE If the automated Power Level Accuracy performance test is performed, the RF Level Accuracy performance test is not required.

Table 8-90. RF Level Accuracy Performance Test with Option 1EA and 1E6 - Part 3

Frequency (MHz)	Amplitude (dBm)	Limits (dBm)			Uncertainty (\pm dB)
		Lower	Measured	Upper	
3.0	13	11.5		14.5	0.23
249.9	18	16.5		19.5	0.23
400	18	16.5		19.5	0.23
999.9	18	16.5		19.5	0.23
1500	17	15.5		18.5	0.23
2100	15	13.5		16.5	0.40
2500	13	11.5		14.5	0.58
3200	11	9.0		13.0	0.58
4000	11	9.0		13.0	0.58

NOTE If the automated Power Level Accuracy performance test is performed, the RF Level Accuracy performance test is not required.

Table 8-91. RF Level Accuracy Performance Test - Part 4

Frequency (MHz)	Amplitude (dBm)	Limits (dBm)			Uncertainty (\pm dB)
		Lower	Measured	Upper	
2000	-25.9	-26.9		-24.9	0.16
	-35.9	-36.9		-34.9	0.16
	-45.9	-46.9		-44.9	0.16
	-55.9	-56.9		-54.9	0.16
2499	-25.9	-26.9		-24.9	0.16
	-35.9	-36.9		-34.9	0.16
	-45.9	-46.9		-44.9	0.16
	-55.9	-56.9		-54.9	0.16
3200	-25.9	-27.4		-24.4	0.19
	-35.9	-37.4		-34.4	0.19
	-45.9	-47.4		-44.4	0.19
	-55.9	-57.4		-54.4	0.19
3200	-25.9	-27.9		-23.9	0.21
	-35.9	-37.9		-33.9	0.21
	-45.9	-47.9		-43.9	0.21
	-55.9	-57.9		-53.9	0.21

Table 8-92. Pulse Modulation On/Off Ratio Performance Test Option 1E6

Frequency (MHz)	Limits (dB)		Uncertainty (±dB)
	Measured	Upper	
100		80	1.8
500		80	2
1000		80	2
1500		80	2
2000		80	2
2300		70	1.8
2500		70	2
2700		70	2
3000		70	2
3200		70	2
3500		70	2
3700		70	2
4000		70	2

Table 8-93. Pulse Modulation Rise Time Performance Test Option 1E6

Frequency (MHz)	Limits (ns)		Uncertainty (±ns)
	Measured	Upper	
1000		10	1

Table 8-94. Internal Timebase: Aging Rate Performance Test Option 1E5

Limits (kHz)			Uncertainty (±Hz)
Lower	Measured	Upper	
		$5 \times 10^{-10}/\text{day}$	$\pm\pm 5.6 \times 10^{-11}$

9 Supplemental Verification Tests

The procedures in this chapter test the electrical performance of the signal generator. These tests do not require access to the interior of the instrument.

This chapter contains the following information:

Required Test Equipment

A list of all the equipment required to perform these supplemental verification tests. For a comprehensive list of all test equipment required to perform these tests plus the manual adjustments, the manual performance tests, and the automated adjustments and performance tests, see Chapter 5, "Service."

Supplemental Verification Tests

A list of all the equipment required to perform these supplemental verification tests. For a comprehensive list of all test equipment required to perform these tests plus the manual adjustments, the manual performance tests, and the automated adjustments and performance tests, see Chapter 5, "Service."

Attention!

Before performing this test, make sure the following conditions exist:

- The signal generator has had at least a one hour warm-up and has been calibrated within the last year.
- The ambient temperature is 25 ± 5 °C.
- The line voltage change is less than $\pm 5\%$.

Required Test Equipment List

- 3458A Digital Multimeter (DMM)
 - Range: -50 V to +50 V
 - Functions: DC and AC
 - DC accuracy: 0.01%
 - Input impedance: > 10M Ω
 - AC range: 1 kHz
 - AC accuracy: $\pm 0.1\%$
- 5350B Frequency Counter
 - Frequency range: 10 Hz to 20 GHz
 - Frequency accuracy: ± 4 Hz at 4000 MHz
(Includes reference accuracy and counter accuracy)
- 8493A Option 010 10 dB Attenuator
 - No substitutes

CW Frequency Accuracy Supplemental Verification Test

Connect the Test Equipment

Figure 9-1. Frequency Accuracy Equipment Setup

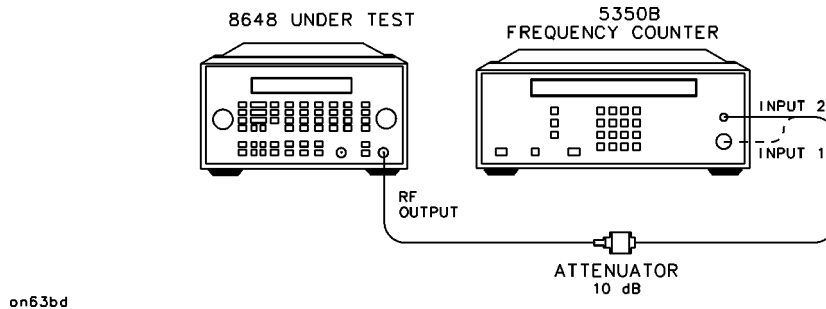

Configure the Frequency Counter

- For frequencies < 10 MHz:
Use Input 2; press 1 M Ω .
- For frequencies > 10 MHz and < 500 MHz:
Use Input 2; press 50 Ω .
- For frequencies > 500 MHz:
Use Input 1; press AUTO.

Configure the 8648

1. Set the amplitude; press **AMPLITUDE**, 4, dB(m).
2. Turn the RF output on; press **RF ON/OFF**.

Measure Frequency Accuracy

1. Set the frequencies shown in the test record.
2. For each data point, measure the carrier frequency with FM turned off, press **MOD ON/OFF**.
3. Record the measured frequency in the test record.
4. Compute the error (difference) and compare it to the corresponding limits.

Test Record

- 8648A: [Table 9-1.](#)
- 8648B: [Table 9-2.](#)
- 8648C: [Table 9-3.](#)
- 8648D: [Table 9-4.](#)
- 8648A Option 1E5: [Table 9-5.](#)
- 8648B Option 1E5: [Table 9-6.](#)
- 8648C Option 1E5: [Table 9-7.](#)
- 8648D Option 1E5: [Table 9-8.](#)

Table 9-1. 8648A Frequency Accuracy Supplemental Verification Test

Frequency (MHz)	Limits (Hz)			Uncertainty (\pm Hz)
	Lower	Measured	Upper	
0.5	-1.5		1.5	1.0
1	-3		3	1.0
10	-30		30	1.0
50	-150		150	1.0
100	-300		300	1.0
500	-1500		1500	1.0
1000	-3000		3000	1.0

Table 9-2. 8648B Frequency Accuracy Supplemental Verification Test

Frequency (MHz)	Limits (Hz)			Uncertainty (\pm Hz)
	Lower	Measured	Upper	
0.5	-1.5		1.5	1.0
1	-3		3	1.0
10	-30		30	1.0
50	-150		150	1.0
100	-300		300	1.0
500	-1500		1500	1.0
1000	-3000		3000	1.0
2000	-6000		6000	1.0

Table 9-3. 8648C Frequency Accuracy Supplemental Verification Test

Frequency (MHz)	Limits (Hz)			Uncertainty (\pm Hz)
	Lower	Measured	Upper	
0.5	-1.5		1.5	1.0
1	-3		3	1.0
10	-30		30	1.0
50	-150		150	1.0
100	-300		300	1.0
500	-1500		1500	1.0
1000	-3000		3000	1.0
2000	-6000		6000	1.0
3000	-9000		9000	1.0
3200	-9600		9600	1.0

Table 9-4. 8648D Frequency Accuracy Supplemental Verification Test

Frequency (MHz)	Limits (Hz)			Uncertainty (\pm Hz)
	Lower	Measured	Upper	
0.5	-1.5		1.5	1.0
1	-3		3	1.0
10	-30		30	1.0
50	-150		150	1.0
100	-300		300	1.0
500	-1500		1500	1.0
1000	-3000		3000	1.0
2000	-6000		6000	1.0
3000	-9000		9000	1.0
3200	-9600		9600	1.0
4000	-12000		12000	1.0

Table 9-5. 8648A Option 1E5 Frequency Accuracy Supplemental Verification Test

Frequency (MHz)	Limits (Hz)			Uncertainty (\pm Hz)
	Lower	Measured	Upper	
0.5	-1.0		1.0	1.0
1	-1.0		1.0	1.0
10	-2.0		2.0	1.0
50	-8.0		8.0	1.0
100	-15.0		15.0	1.0
500	-75.0		75.0	1.0
1000	-150		150	1.0

Table 9-6. 8648B Option 1E5 Frequency Accuracy Supplemental Verification Test

Frequency (MHz)	Limits (Hz)			Uncertainty (\pm Hz)
	Lower	Measured	Upper	
0.5	-1.0		1.0	1.0
1	-1.0		1.0	1.0
10	-2.0		2.0	1.0
50	-8.0		8.0	1.0
100	-15.0		15.0	1.0
500	-75.0		75.0	1.0
1000	-150		150	1.0
2000	-300		300	1.0

Table 9-7. 8648C Option 1E5 Frequency Accuracy Supplemental Verification Test

Frequency (MHz)	Limits (Hz)			Uncertainty (±Hz)
	Lower	Measured	Upper	
0.5	-1.0		1.0	1.0
1	-1.0		1.0	1.0
10	-2.0		2.0	1.0
50	-8.0		8.0	1.0
100	-15.0		15.0	1.0
500	-75.0		75.0	1.0
1000	-150		150	1.0
2000	-300		300	1.0
3000	-450		450	1.0
3200	-480		480	1.0

Table 9-8. 8648D Option 1E5 Frequency Accuracy Supplemental Verification Test

Frequency (MHz)	Limits (Hz)			Uncertainty (±Hz)
	Lower	Measured	Upper	
0.5	-1.0		1.0	1.0
1	-1.0		1.0	1.0
10	-2.0		2.0	1.0
50	-8.0		8.0	1.0
100	-15.0		15.0	1.0
500	-75.0		75.0	1.0
1000	-150		150	1.0
2000	-300		300	1.0
3000	-450		450	1.0
3200	-480		480	1.0
4000	-600		600	1.0

9 kHz RF Level Accuracy Supplemental Verification Test

Connect the Test Equipment

Figure 9-2. 9 kHz RF Level Accuracy Equipment Setup

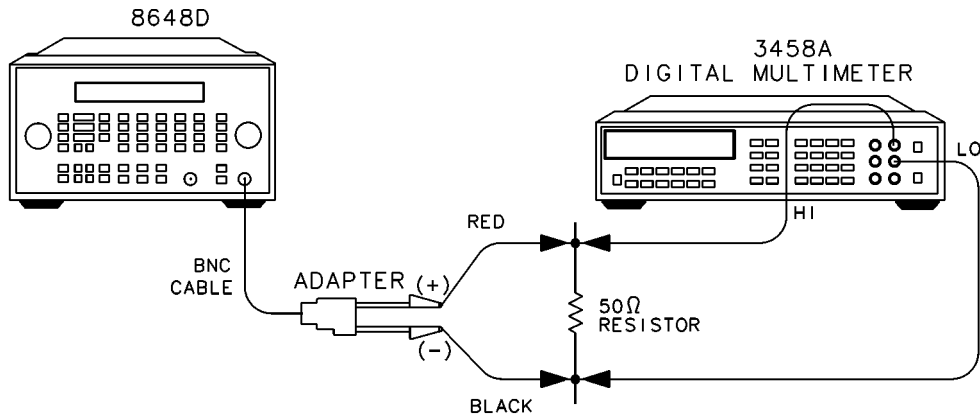

on67bd

Configure the Multimeter (DMM)

- Function ACV
- Range AUTO
- Connect the Positive and Ground leads from the Input (2 Wire) connector across a 50 Ω resistor (1/4 W, 0.1% tolerance).

Configure the 8648

- Set the frequency; press **FREQUENCY**, 9, kHz.
- Set the amplitude; press **AMPLITUDE**, 10, dBm.
- Connect the BNC cable to the RF OUTPUT of the 8648.
- Connect the BNC splitter to the other end of the BNC cable attaching:
 - the splitter's positive lead to the side of the resistor that is connected to the HI lead from the DMM
 - the splitter's ground lead to the side of the resistor that is connected to the LO lead from the DMM
- Turn on the RF output; press **RF ON/OFF**.

Measure RF levels

1. Set the amplitudes shown in the test record.

2. For each data point, measure the AC voltage (V_{ac}) dropped across the resistor.
3. Record the measured result in the test record.
4. Record the test results and compare the results with the limits in the test record.

Test Record

- 8648B: [Table 9-9.](#)
- 8648C: [Table 9-10.](#)
- 8648D: [Table 9-11.](#)

Table 9-9. 8648B 9 kHz RF Level Accuracy Supplemental Verification Test

Power Level (dBm)	Limits (kHz)			Uncertainty (\pm dB)
	Lower	Measured	Upper	
10	596		841	0.21
0	188		265	0.21
-10	59		84	.021
-20	19		27	0.21
-30	6.0		8.0	0.21
-40	1.9		2.7	0.21
-50	0.566		0.894	0.25
-60	0.179		0.283	0.25
-70	0.055		0.094	0.39

Table 9-10. 8648C 9 kHz RF Level Accuracy Supplemental Verification Test

Power Level (dBm)	Limits (kHz)			Uncertainty (\pm dB)
	Lower	Measured	Upper	
10	596		841	0.21
0	188		265	0.21
-10	59		84	.021
-20	19		27	0.21
-30	6.0		8.0	0.21
-40	1.9		2.7	0.21
-50	0.566		0.894	0.25
-60	0.179		0.283	0.25
-70	0.055		0.094	0.39

Table 9-11. 8648D 9 kHz RF Level Accuracy Supplemental Verification Test

Power Level (dBm)	Limits (kHz)			Uncertainty (\pm dB)
	Lower	Measured	Upper	
10	596		841	0.21
0	188		265	0.21
-10	59		84	.021
-20	19		27	0.21
-30	6.0		8.0	0.21
-40	1.9		2.7	0.21
-50	0.566		0.894	0.25
-60	0.179		0.283	0.25
-70	0.055		0.094	0.39

Index

A

- A1
 - theory of operation, [5a-5](#)
- A10
 - theory of operation, [5a-14](#)
- A11
 - theory of operation, [5a-15](#)
- A12
 - theory of operation, [5a-16](#)
- A13
 - theory of operation, [5a-17](#)
- A2
 - theory of operation, [5a-7](#)
- A3
 - theory of operation, [5a-8](#)
- A4
 - theory of operation, [5a-9](#)
- A5
 - theory of operation, [5a-10](#)
- A6
 - theory of operation, [5a-11](#), [5a-12](#)
- A7
 - theory of operation, [5a-13](#)
- ac power
 - connection, [3-3](#)
- AC symbol, [vi](#)
- adjustment
 - AM level, [7-12](#)
 - AM level FE, [7-16](#)
 - AM modulator, [7-21](#)
 - audio generator, [7-27](#)
 - DCFM, [7-26](#)
 - detector offset, [7-14](#)
 - filter path, [7-35](#)
 - FSK deviation, [7-34](#)
 - HF power level accuracy, [7-28](#)
 - LF output level, [7-31](#)
 - LF power level accuracy, [7-32](#)
 - motherboard audio path, [7-24](#)
 - output level, [7-15](#)
 - output level frequency extension, [7-20](#)
 - pager encoder timebase frequency, [7-7](#)
 - predistortion and detector offset, [7-18](#)
 - prelevel, [7-19](#)
 - reference oscillator, [7-5](#)
 - time base DAC, [7-23](#)
- adjustments
 - automated, [7-9](#)
 - manual, [7-4](#)
- ADRS, [1b-38](#)

- altitude, [3-6](#)
- AM, [1b-5](#)
 - level adjustment, [7-12](#)
 - level and distortion adjustment, [7-10](#)
 - level FE adjustment, [7-16](#)
 - modulator adjustment, [7-21](#)
- AM level and distortion, [7-10](#)
- amplitude, [1a-3](#), [1b-5](#)
 - RF OFF, [1b-47](#)
- attenuator, [1b-47](#)
 - part number, [6-6](#), [6-12](#)
 - theory of operation, [5a-13](#), [5a-15](#)
- ATTN HOLD, [1b-47](#)
- audio generator
 - adjustment, [7-27](#)
 - internal, [1b-44](#)
- audio path calibration, [7-24](#)
- audio source, [1b-45](#)
- automated adjustments, [7-9](#)
- auxiliary interface, [1b-49](#)

B

- backspace, [1b-32](#)
- bus, [7-2](#)
- busy, [1b-53](#)

C

- calibration cycle, [8-2](#)
- Canadian Standards Association, [v](#)
- carton, [3-9](#)
- CE mark, [v](#)
- clearing all registers, [1b-34](#)
- clearing memory, [1b-34](#)
- clearing memory, [1b-34](#)
- computer requirements, [7-36](#)
- connection
 - ac power, [3-3](#)
 - to other instruments, [3-7](#)
- container, [3-9](#)
- contrast, [1b-49](#)
- controller
 - theory of operation, [5a-8](#)
- copy, [1b-53](#)
- CSA mark, [v](#)

D

- DAC calibration, [7-23](#)
- damage, [3-2](#)

Index

- datapacks
 - adding, 7-50
 - removing, 7-51
 - DCFM adjustment, 7-26
 - delete
 - DEL, 1a-11
 - delta, 1b-3
 - detector offset adjustment, 7-14, 7-18
 - device drivers
 - adding, 7-46
 - removing, 7-47
 - display, 1b-2, 1b-31
 - REG, 1a-7
 - SEQ, 1a-7
 - theory of operation, 5a-5
 - distortion adjustment, 7-10
 - drivers, 7-46, 7-47, 7-48, 7-49
- E**
- emf, 1b-33
 - ENTER, 1b-32
 - environment, 3-9
 - equipment required, 5-3
 - performance tests, 8-3
 - supplemental verification tests, 9-2
 - European Community trademark, v
 - exiting software, 7-57
 - EXT AC, 1b-45
 - EXT DC, 1b-45
 - extender, test point, 7-2
 - external pulse input, 1b-50
 - external source, 1b-46
- F**
- fan
 - part number, 6-6, 6-12
 - filter path adjustment, 7-35
 - firmware output
 - part number, 6-6
 - firmware upgrade kit
 - part number, 6-3, 6-12
 - FM, 1b-5
 - frequency, 1a-3, 1b-4
 - frequency extension
 - adjustment, 7-20
 - theory of operation, 5a-14
 - frequency extension kit
 - part number, 6-12
 - front frame kit
 - part number, 6-3
 - front panel
 - theory of operation, 5a-5
 - FSK deviation adjustment, 7-34
 - fuse, 3-3
- G**
- GPIB, 1b-38
 - address, 1b-38
 - GPIB cable, 7-2
 - grounding, 3-3
- H**
- HF power level accuracy adjustment, 7-28
 - HI, 1b-45
 - humidity, 3-6
- I**
- INCR SET, 1a-5
 - ranges, 1b-31
 - installation, 3-1
 - connect power cable, 3-3
 - replacing the fuse, 3-3
 - shipping the signal generator, 3-9
 - storing the signal generator, 3-8
 - turn on the signal generator, 3-6
 - unpack, 3-2
 - installing the software, 7-37
 - instruction manual symbol, v
 - instrument
 - preset settings, 1b-34
 - INT 1 kHz, 1b-44
 - INT400 Hz, 1b-44
 - interface bus, 7-2
 - internal reference oscillator adjustment, 7-5
 - ISM 1-A symbol, vi
- K**
- keyboard
 - theory of operation, 5a-5
 - knob, 1b-2
- L**
- level
 - modulation, 1b-46
 - RF output, 1b-5
 - LF output level adjustment, 7-31

Index

LF power level accuracy adjustment, 7-32
line module
 part number, 6-6, 6-12
LO, 1b-45
LOCAL, 1b-38

M

manual adjustments, 7-4
memory, 1a-7, 1b-39
 clearing, 1b-34
 interface, 1b-53
 remote interface, 1b-52
 sequence, 1a-8
MOD INPUT/OUTPUT, 1b-46
MOD ON/OFF, 1b-44
modulation, 1a-4, 1a-21, 1b-5
 HI/LO, 1b-45
 level, 1b-46
 OFF, 1b-45
 source, 1b-43, 1b-46
modulation distribution
 theory of operation, 5a-8
modulation generator, 1b-44
 assembly description, 5a-18
motherboard, 7-2
 audio path calibration, 7-24
 theory of operation, 5a-8
motherboard kit
 part number, 6-3, 6-6, 6-12

N

NEXT, 1b-31

O

offset, 1a-16, 1b-3
ordering parts, 6-1
output
 level frequency extension adjustment, 7-20
 level output adjustment, 7-15
 part number, 6-12
 theory of operation, 5a-11, 5a-12

P

packaging, 3-9
pager encoder
 assembly description, 5a-19
 part number, 6-6
 timebase frequency adjustment, 7-7

pager encoding, 1a-23
parts list, 6-1
PC requirements, 7-36
performance tests, 8-1
 AM accuracy, 8-16
 AM accuracy (Option 1E2), 8-17
 AM distortion, 8-19
 DC FM frequency error, 8-28
 FM accuracy, 8-7
 FM accuracy (Option 1E2), 8-10
 FM distortion, 8-13
 FSK deviation accuracy, 8-40
 harmonics, 8-26
 internal timebase aging rate, 8-46
 pager encoder timebase accuracy, 8-39
 phase modulation distortion, 8-21
 power level accuracy, 8-49
 pulse modulation on/off ratio, 8-35
 pulse modulation rise time, 8-37
 required test equipment, 8-3
 residual FM, 8-24
 RF level accuracy, 8-30
 selection, 7-54
 spurious, 8-27
performance verification cycle, 8-2
plug, 3-5
post regulator
 theory of operation, 5a-8
post-repair procedure
 8648A, 5-6
post-repair procedures
 8648B/C/D, 5-6
power, 3-3
 cable, 3-3, 3-5
 memory interface, 1b-53
POWER DEL sequence, 1b-34
POWER DEL sequency, 1b-34
power level accuracy
 adjustment, 7-28
power on symbol, v
power supply
 part number, 6-3, 6-6, 6-12
 theory of operation, 5a-7
predistortion and detector offset adjustment, 7-18
prelevel adjustment, 7-19
preset conditions, 1b-34
PREV, 1b-31
printing test results, 7-57
pulse modulation
 selection, 1b-29, 1b-30

Index

pulse modulator
theory of operation, 5a-17

R

rear panel, 1b-49
recall, 1a-10, 1a-13, 1b-40, 1b-42
REF ON/OFF, 1b-3
REF SET, 1a-16, 1b-2
reference
theory of operation, 5a-9
reference connectors, 1b-49
reference kit
part number, 6-3, 6-6, 6-12
reference oscillator adjustment, 7-5
REG, 1a-8, 1a-13, 1b-40
register, 1b-39
clearing, 1b-34
delete, 1a-11
REG, 1a-13, 1b-40
remote interface, 1b-51
re-numbering, 1a-12
RF output, 1b-47, 1b-48
sequence, 1a-8
total, 1b-40
remote interface
memory, 1b-52
removing
software, 7-41
repair, 5-1
replaceable parts, 6-1
results of tests
saving, 7-55
reverse power protection
theory of operation, 5a-16
reverse-power, 1b-48
RF ON/OFF, 1b-47
RF output, 1a-3
amplitude, 1b-5
frequency, 1b-5
ON/OFF, 1a-3
RPG
theory of operation, 5a-5
RPP
part number, 6-12
running
adjustments, 7-56
performance tests, 7-56

S

safety class I, 3-3
safety earth ground, 3-3
SAV, 1b-40
SAVE, 1b-40
SAV, 1a-8
SEQ, 1a-8
sequence, 1b-51
SEQ, 1b-41
total, 1b-39
service
information, 5-1
support software, 7-36
SHIFT, 1b-32
shipping
instructions, 5-2
the signal generator, 3-9
sig gen synth
kit part number, 6-3, 6-6
theory of operation, 5a-10
sig gen synth kit
part number, 6-12
software
adding test equipment, 7-42
administration, 7-42
editing test equipment, 7-46
installation, 7-37
removing test equipment, 7-45
starting, 7-53
source, 1b-43, 1b-46
standby symbol, vi
START/STOP, 1b-31
starting the software, 7-53
status, 1b-38
storing, 3-8
supplemental verification tests, 9-1
9 kHz RF level accuracy, 9-8
frequency accuracy, 9-3
required test equipment, 9-2
support software, 7-36
synthesizer
theory of operation, 5a-10

T

TCXO, 5a-19
temperature, 3-6
terminate, 1b-39
test drivers
adding, 7-48

Index

- removing, [7-49](#)
- test equipment
 - recommended, [5-3](#)
- test point extender, [7-2](#)
- test record
 - 8648A, [8-52](#)
 - 8648B, [8-72](#)
 - 8648C, [8-96](#)
 - 8648D, [8-122](#)
- test results
 - printing, [7-57](#)
 - reviewing, [7-56](#)
 - saving, [7-55](#)
- theory of operation
 - 10 MHz, [5a-9](#)
 - A1, [5a-5](#)
 - A10, [5a-14](#)
 - A11, [5a-15](#)
 - A12, [5a-16](#)
 - A13, [5a-17](#)
 - A2, [5a-7](#)
 - A3, [5a-8](#)
 - A4, [5a-9](#)
 - A5, [5a-10](#)
 - A6, [5a-11](#), [5a-12](#)
 - A7, [5a-13](#)
 - attenuator, [5a-13](#), [5a-15](#)
 - controller, [5a-8](#)
 - display, [5a-5](#)
 - frequency extension, [5a-14](#)
 - front panel, [5a-5](#)
 - keyboard, [5a-5](#)
 - modulation distribution, [5a-8](#)
 - motherboard, [5a-8](#)
 - output, [5a-11](#), [5a-12](#)
 - post regulator, [5a-8](#)
 - power supply, [5a-7](#)
 - pulse modulator, [5a-17](#)
 - reference, [5a-9](#)
 - reverse power protection, [5a-16](#)
 - RPG, [5a-5](#)
 - sig gen synth, [5a-10](#)
 - synthesizer, [5a-10](#)
- timebase, [1b-49](#)
 - adjustment, [7-5](#), [7-7](#)
 - DAC calibration, [7-23](#)
- TIMEBASE ADJ, [1b-50](#)

U

- uninstalling the software, [7-41](#)
- units conversion, [1b-32](#)

V

- verification tests, [9-1](#)
- vernier, [1b-47](#)